

merchant **SIX**
D I S T I N C T L Y D I F F E R E N T

OPERATOR'S GUIDE

MODELS 180, 181, 980, 981, 448, 449



CRANE VENDING SOLUTIONS

12955 ENTERPRISE WAY • BRIDGETON, MISSOURI 63044-1200 USA • WWW.CRANEMS.COM

©AUG2009 VERS1- 0809 P/N 1810025

Your new merchandiser has been engineered to our own rigid safety and performance standards. It has been designed to comply with sanitation and health guidelines recommended by the Automatic Merchandising Health-Industry Council (AMHIC) and it conforms to all NAMA safety recommendations.

This machine has been manufactured in accordance with the safety standards of both Underwriter's Laboratories and the Canadian Standards Association. To maintain this degree of safety and to continue to achieve the level of performance built into this machine, it is important that installation and maintenance be performed so as to not alter the original construction or wiring and that replacement parts are as specified in the Parts Manual. Your investment in this equipment will be protected by using this Operators' Guide and the Parts Manual in your operation, service and maintenance work. By following prescribed procedures, machine performance and safety will be preserved.

Models 180, 181, 448 & 449

Parts and Support

Call

National Vendors

Parts: 1-800-621-7278

Service: 1-800-628-8363

www.cranems.com

For faster service, please have your account number ready before calling

Models 980 & 981

Parts and Support

Call

Automatic Products

Parts: 1-800-784-6438

Service: 1-800-523-5932

www.automaticproducts.com



VENDING SOLUTIONS

12955 ENTERPRISE WAY · BRIDGETON, MISSOURI 63044-1200 USA

Table of Contents

Preliminary	5
Power Requirements	5
Unpacking the Merchandiser	5
Controls and Indicators	6
Turning the Merchandiser ON and OFF	8
Initial Set-Up.....	9
Moving the Merchandiser Through a Narrow Doorway	9
Positioning the Merchandiser	11
Snack Section Set-Up	11
Placing Trays in the Loading Position	11
Setting Up Trays to Vend Products	12
Setting Up Trays to Vend Wide Products.....	12
Removing Standard Trays	13
Installing Standard Trays.....	14
Removing a Bottle Tray.....	15
Installing a Bottle Tray	15
Removing and Installing Column Dividers	16
Operating Trays Outside the Merchandiser	16
Replacing a Motor With a Spiral Bearing	16
Connecting and Disconnecting a Motor Harness	17
Removing and Installing Spirals.....	18
Removing a Spiral Coupler	20
Removing and Installing a Spiral Motor	20
Installing a Gear.....	21
Installing a Spiral Coupler	22
Moving Trays Up or Down.....	23
Installing and Removing Product Spacers	25
Loading Trays with Product	26
Spiral Capacity Color Codes	26
Returning the Trays to the Vending Position	31
Installing and Setting Price Labels	32
Installing Selection ID Labels	34
Motor Position	35
Final Installation	36
Leveling the Merchandiser	36
Installing the Base Plate.....	37
Setting Up and Loading the Coin Mechanism.....	38
TriTeq Lock Information.....	38
Final Checkout.....	39
Operational Readiness Check	39
Spiral Indexing Procedure (Two Spirals, One Or Two Motors)	40
Spiral Indexing Procedure (One Spiral, One Motor).....	40

Testing the Bill Validator	41
Service Keypad Shortcut Keys	43
Programming: Data Recall	45
View Non Resettable Sales and Vend Data	45
View Non Resettable Sales and Vend Data By Product	47
View Non Resettable Sales and Vend Data - Cash	49
View Non Resettable Sales and Vend Data - Cashless	51
View Non Resettable Sales and Vend Data - Token	53
View Resettable Sales and Vend Data	55
View Resettable Sales and Vend Data - Cash	59
View Resettable Sales and Vend Data - Cashless	61
Clear Resettable Sales and Vend Data	65
View Timed Events - Main Door Openings	66
View Timed Events - Power Losses	67
View Timed Events - Last Data Clear	68
View Timed Events - Last Price Setting	69
View Timed Events - Last Vend	70
View Timed Events - Last Clock Set	71
View Timed Events - Last Timed Backup	72
View Identification Numbers - Main PCB	73
View Identification Numbers - Coin Mechanism	74
View Identification Numbers - Bill Validator	75
View Identification Numbers - Card Reader	76
Print Data	77
Programming: Diagnostic	78
Check for Errors	78
Diagnostic Error Messages	79
Programming: Test	82
Test Vend a Selection	82
Test Vend Without SureVend™	83
Test SureVend™ Calibration	84
Testing the Motors - Motor Test Summary	85
Homing the Motors - Motor Status Detail	86
Table: Motor Status Detail Menu Screen	88
Test the Coin Return Motor	89
Test the Display	92
Test the Keypads - Keypad Entry	93
Programming: Prices	94
Set Prices for Individual Selections	94
Set One Price for the Entire Machine	95
Set Prices by Trays	96
Programming: Product Configuration	97
View Configuration Version	97
Turn SureVend™ On and Off	98
Set SureVend™ Options	99
Set SureVend™ Anti-Jackpot Timer	101

Set SureVend™ Anti-Jackpot Trigger.....	102
Selection Configuration.....	103
FIFO (First In, First Out).....	104
FIFO Setup - Adding Groups	104
FIFO Setup - Deleting Groups.....	105
FIFO Setup - Editing Groups.....	106
FIFO Setup - View FIFO Mappings.....	107
Couple Motors	108
Special Vend Modes	109
Timed Events-Time of Day Events	109
Timed Events - Backup Events.....	119
Winner Mode	122
Combo Vends	125
Token Enable.....	128
Enable OK Button.....	129
Programming: Free Vend.....	130
Turn Free Vend On/Off	130
Programming: System Settings.....	131
Machine Information - ID Number.....	131
Machine Information - Location.....	133
Set the Date.....	135
Set the Time.....	136
Set Daylight Saving Time.....	137
Select a Language	138
Select the Coin Mechanism	139
View Coins In/Out.....	140
Set Change Without Purchase	141
Set Low Change Message.....	142
Select the Bill Validator.....	143
Set Accept on Low Change	144
Set Bill Acceptance.....	146
Set Token/Coupon Acceptance.....	147
Select the Card Reader.....	148
Set Card Revalue	149
Set Multiple Vend Mode	151
Set Credit for Failed Vend.....	153
Set Communication Mode.....	155
Set Data List	156
Set CA304 Data Type.....	157
Set Data Reset Mode	158
Set Event Reset Mode.....	159
Set Printer Baud Rate.....	160
Connect and Disconnect the Data Key	161
Firmware Selection (Serial Flash Menu).....	162
Save Configuration Data to Data Key	163
Save Configuration and Sales Data to Data Key	165

View Image Info (Data Description) on Data Key	167
Load Configuration Data from Data Key to Machine	169
Delete Configuration Data or Configuration and Sales Data from Data Key	171
View Last Backup.....	173
Backup Data.....	174
Restore Data.....	175
Set Screen Contrast.....	176
View Software Version.....	177
View SureVend™ Version	178
View IO Board Software	179
Set Temperature.....	180
Select Tray and Selections to be Controlled by Health Control	181
Set Temperature Units	183
Set Idle Screen Time/Temp Options.....	184
Set Idle Screen Message	186
Set Custom Messages	188
Reset Custom Messages.....	190
NUMERIC/CHARACTER TABLE.....	191
Talker Setup.....	192
Programming: Security Codes	193
Enter Security Code	193
Edit the Supervisor PIN	194
Lock/Unlock Menu Items	195
Programming: Security Codes	198
448/449 Merchant Refrigeration Removal	198
448/449 Merchant Refrigeration Installation.....	198
Schematic.....	199

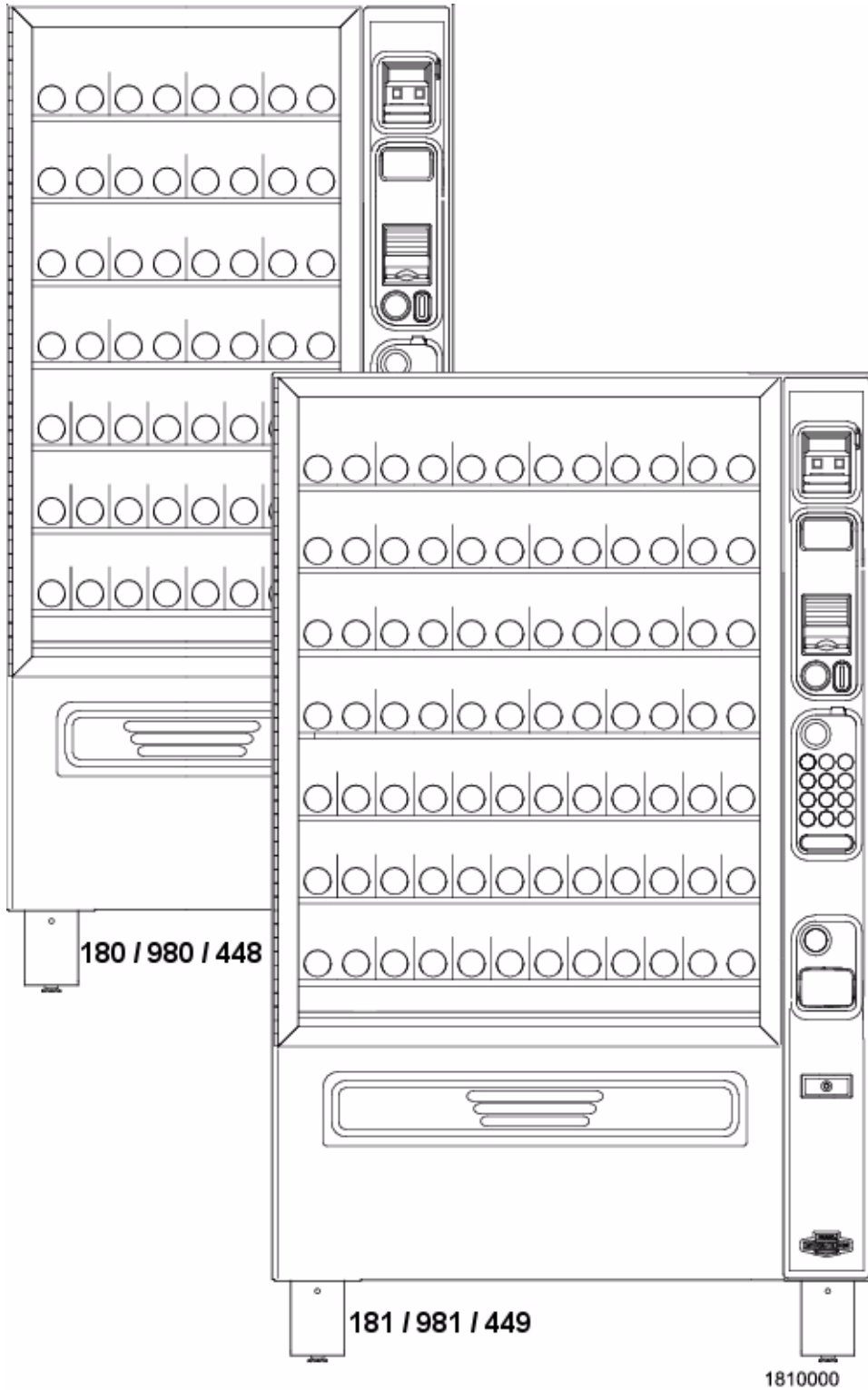

FRONT EXTERIOR VIEWS

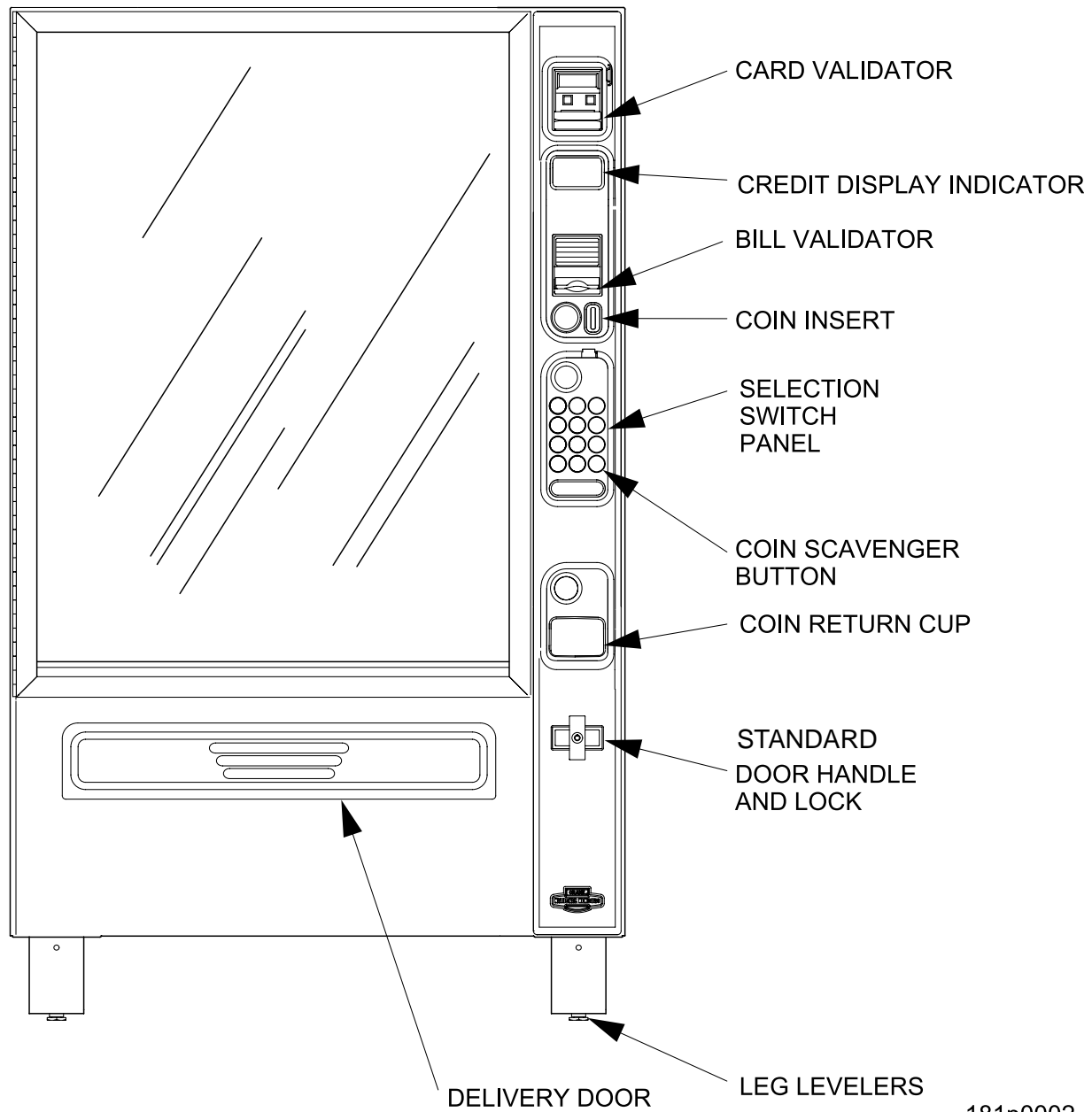

181p0002

MODEL 181 - EXTERIOR VIEW

(Models 180, 980, 981, 448 and 449 have similar appearance)

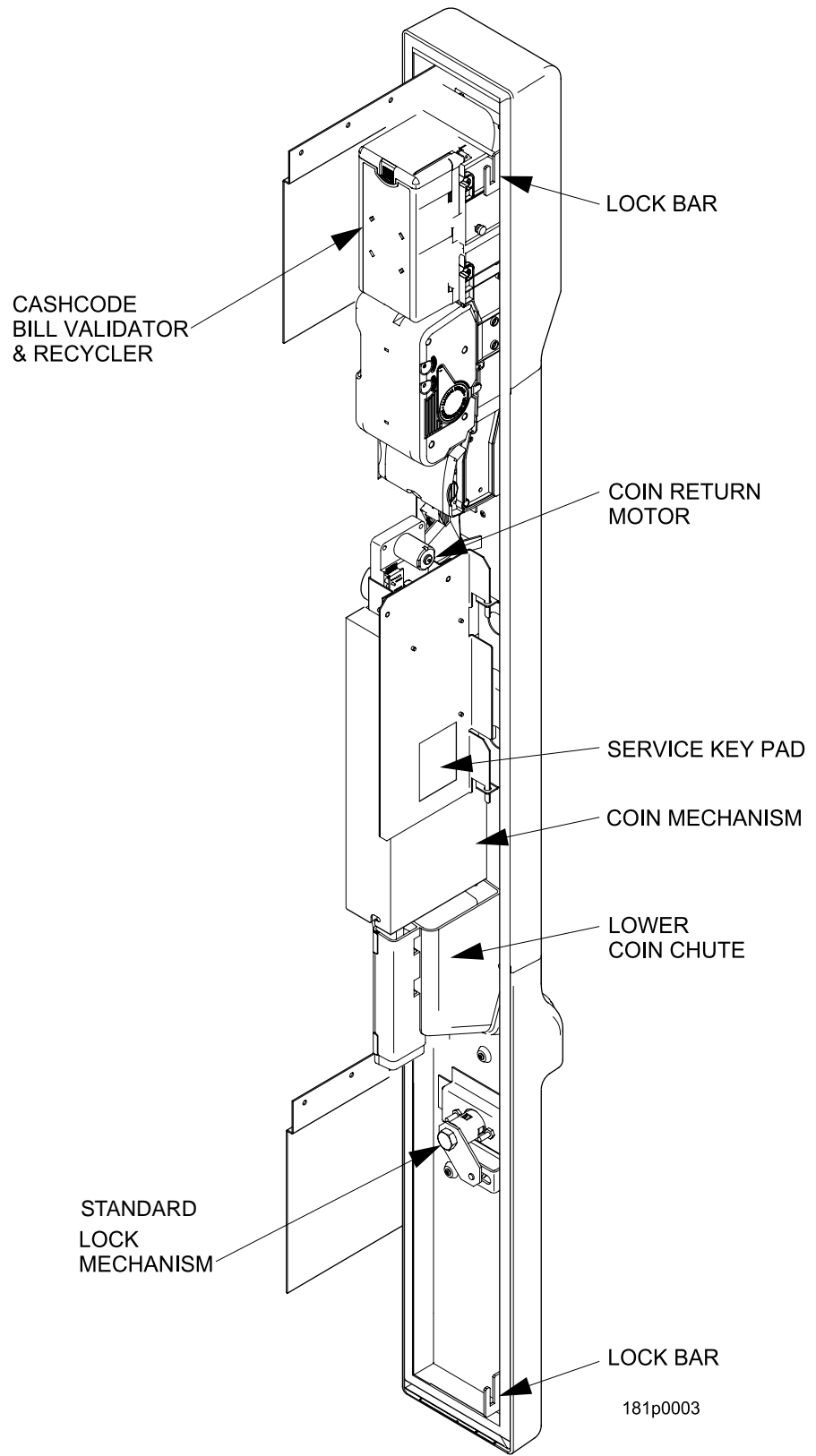

ALL MODELS - MONETARY

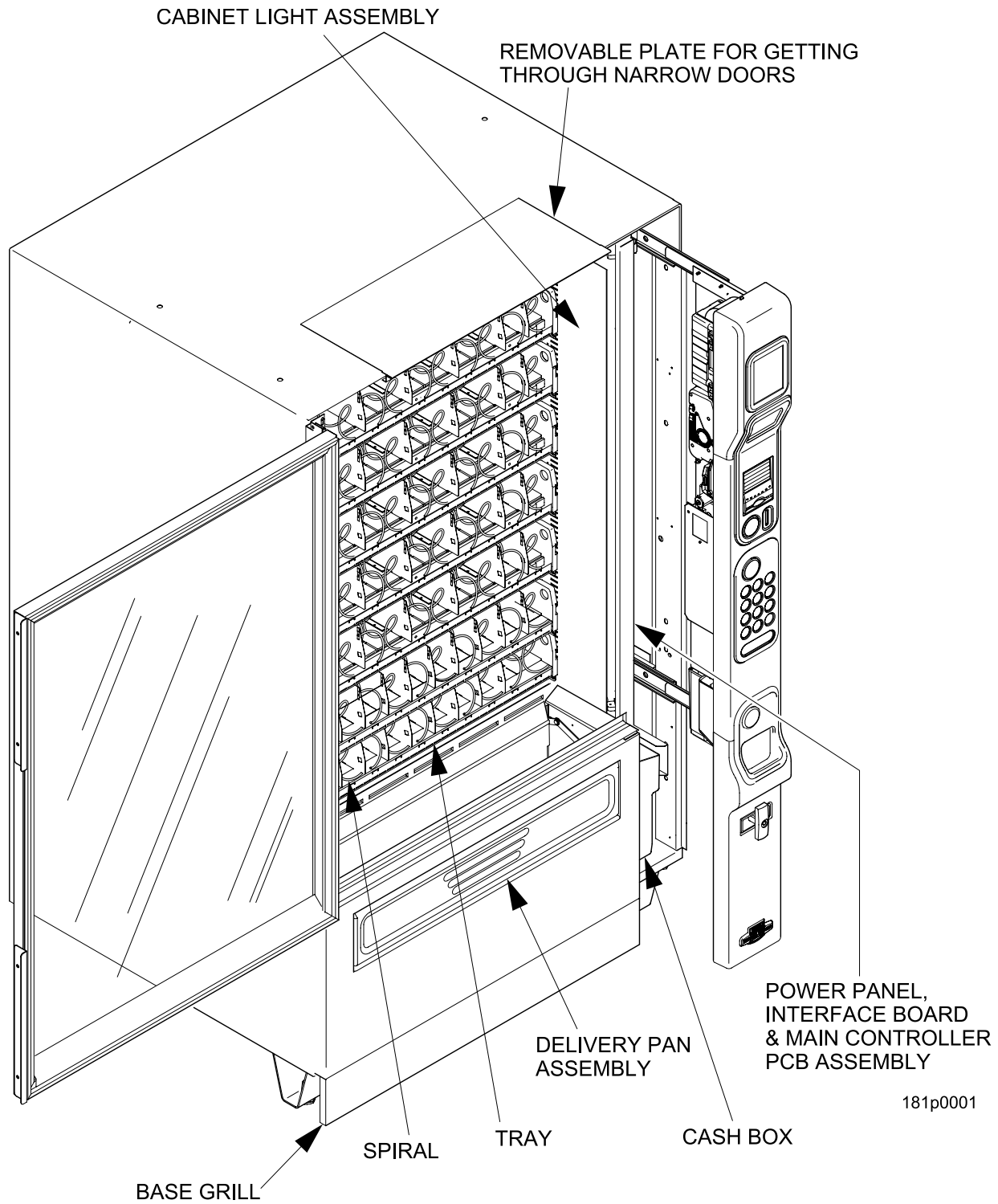

INTERIOR VIEW

Preliminary

Power Requirements

The merchandiser is supplied with a service cord for the country of use and is terminated in a grounding type plug. The wall receptacle used for this merchandiser must be properly polarized, grounded, and of the correct voltage. Operating the merchandiser from a source of low voltage will **VOID YOUR WARRANTY**. Each merchandiser should have its own 15 Amp electrical circuit and that circuit should be protected with a circuit breaker or fuse conforming to local regulations.

1. **Voltage Check** - Place the leads of a voltmeter across the LINE (LIVE) and NEUTRAL terminals of the wall receptacle. The voltmeter should indicate 110-130 volts ac for 120 volt, 60 Hz locations, or 220- 240 volts ac for 230 volt, 50 Hz locations.
2. **Polarity Check** - Place the leads of a voltmeter across the LINE (LIVE) and GROUND terminals of the wall receptacle. The voltmeter should indicate 110-130 volts ac for 120 volt, 60 Hz locations, or 220- 240 volts ac for 230 volt, 50 Hz locations.
3. **Noise Potential Check** - Place the test leads of a voltmeter across the NEUTRAL and GROUND terminals of the wall receptacle. The meter should indicate 0 volts ac. A measurement greater than 1.5 - 2.0 volts ac could result in problems for the merchandiser's electronic circuitry caused by electrical noise.

NOTE

Any deviation from these requirements could result in unreliable performance from your merchandiser.

Unpacking the Merchandiser

Remove all packing materials from the interior of the merchandiser. Keep all documents; warranty cards, etc. Set aside the base plate kit (if present).

Controls and Indicators

INTERLOCK SWITCH

When the monetary slide is open, this switch turns off the optional fan (if so equipped.)

MESSAGE DISPLAY

This is how the merchandiser communicates with the outside world. Customers can see messages about how much money they have put into the merchandiser. The message display also tells customers when a selection is sold out and when vending is free, inhibited, or discounted. The message display shows you what you are doing when you program the merchandiser, and can show you what is wrong if there is a failure.

SELECTION KEYPAD

The customer uses these switches to make selections.

COIN RETURN KEY

Pressing this button returns any coins that have been paid into the merchandiser prior to a vend.

CANCEL KEY

Pressing this button clears any selection keys.

BILL ACCEPTOR (OPTIONAL)

Accepts bills in various denominations, depending upon the type of bill validator, and how the merchandiser is configured.

SERVICE KEYPAD

The service keypad is located on the inside of the monetary section. It gives service personnel the means to program, retrieve data from, and view diagnostic information about, the merchandiser.

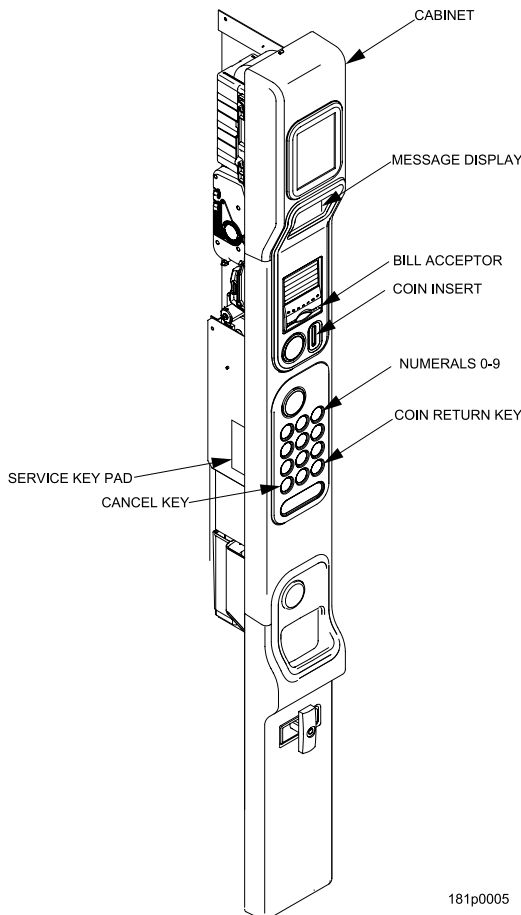

181p0005

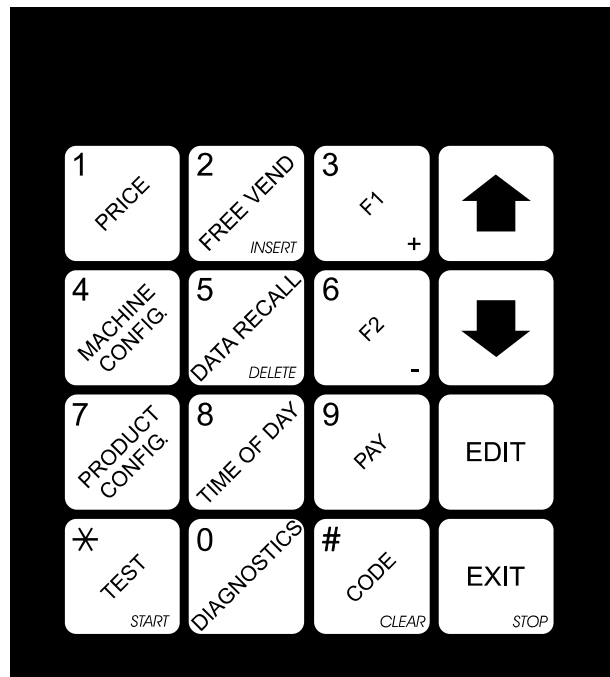

181p0004

Controls and Indicators (continued)

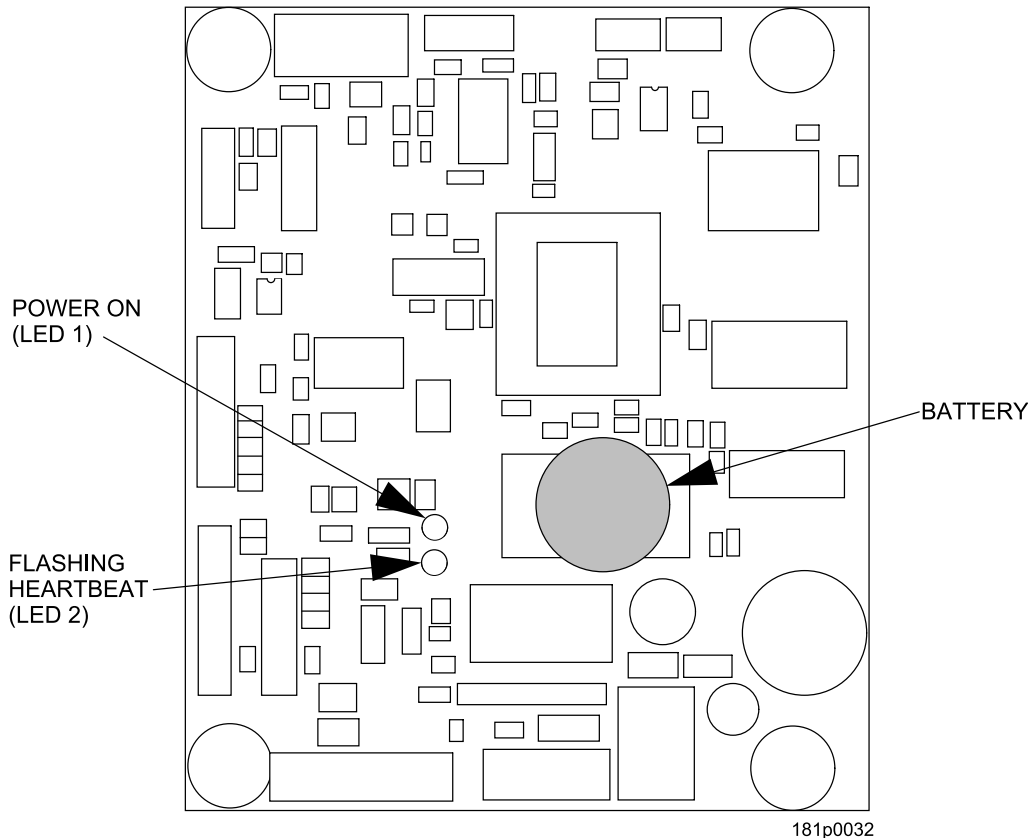
**MAIN CONTROLLER PCB DISPLAY**

This display consists of two light emitting diodes (LED) mounted on the controller PCB.

POWER ON (L.E.D. 1)	When lit, this red LED indicates electrical power is applied to the controller PCB.
HEARTBEAT (L.E.D. 2)	When flashing, this red LED indicates that the controller PCB is active, and the software is operating.

WARNING

**Risk of explosion if battery is replaced with an incorrect type. Battery type is CR2032 / 3V
Dispose of used batteries according to the manufacturer's instructions.**

NORMAL CONDITIONS:

When the merchandiser is operating normally, you should see a steady red **POWER ON** indicator and a flashing red **HEARTBEAT** indicator.
Contact a service representative if any other condition exists.

Turning the Merchandiser ON and OFF

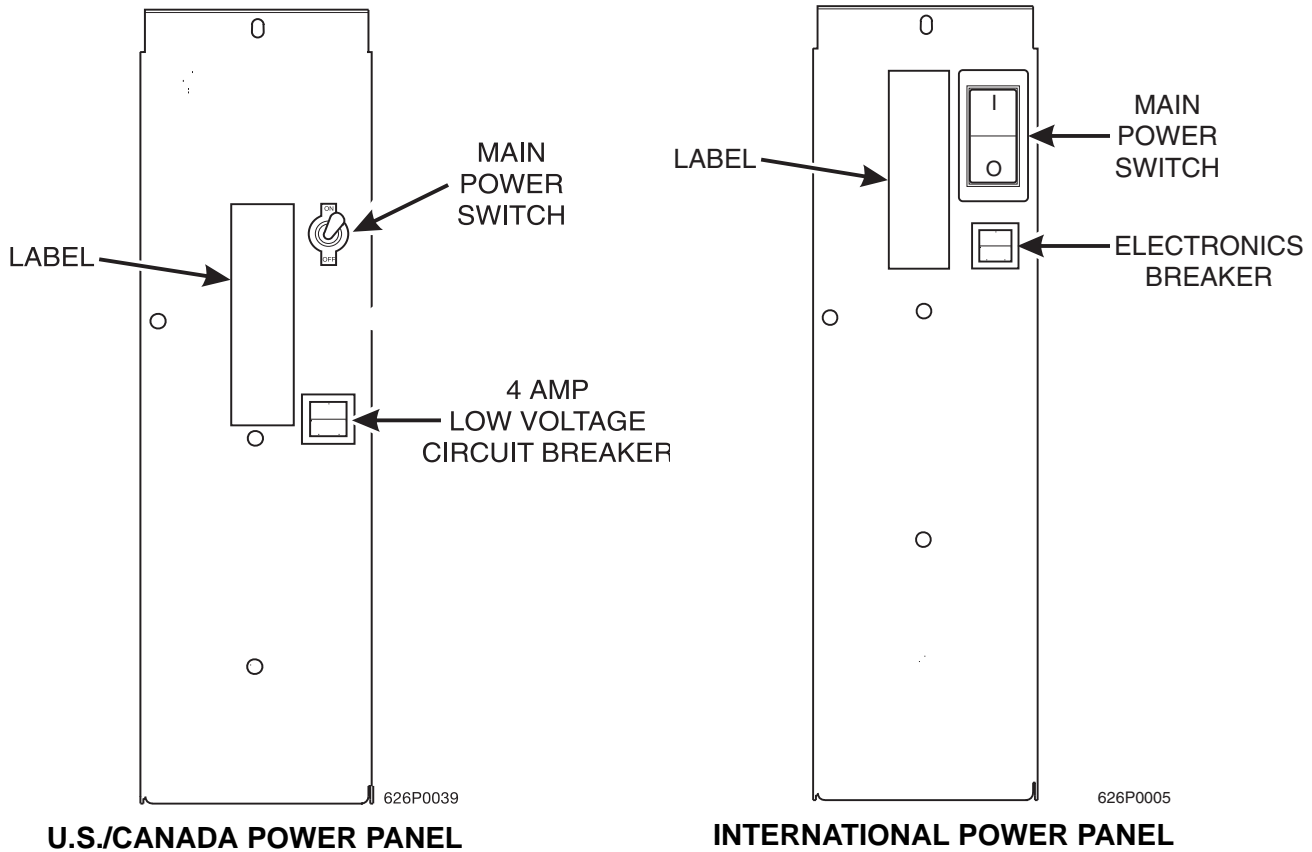

- Power to the merchandiser is controlled by the main power switch, located on the power panel.
- The power panel is on the right side of the merchandiser, behind the monetary door.

WARNING

Lethal voltages are present. Unplug the merchandiser whenever you do one of the following tasks:

- **Change the fluorescent lamp.**
- **Change the ballast.**
- **Connect or disconnect a harness (except a motor harness when the tray has been removed.)**

Failure to do so may result in personal injury.

Initial Set-Up

Moving the Merchandiser Through a Narrow Doorway

NOTE

If necessary, this merchandiser can be moved through an opening as narrow as 30 inches by removing panels at the top and bottom of the cabinet.

REMOVING THE TOP PANEL

(Refer to **Figure 1** at right.)

1. Remove the two screws that secure each end of the panel to the cabinet.
2. Pull the panel forward to remove it from the merchandiser.

REMOVING THE LOWER PANEL AND DELIVERY BIN

(Refer to **Figures 2** and **3** at right.)

1. Open the slide-out monetary and the glass door. Locate the silver tab of the delivery bin latch on the lower delivery bin side of the monetary wall.
2. Lift the latch up to allow the delivery bin assembly to hinge down.
3. Lift up the delivery bin slightly and lift up on the drop rods to allow the rods to clear the stop brackets.
4. Slide the delivery bin assembly to the right to clear the hinges. The delivery bin assembly will not be attached to the machine.
5. Unhook the SureVend™ harness at the SureVend™ board, noting the wire routing.
6. Remove the screws that secure the bottom panel to the cabinet.
7. Pull the panel forward to remove it from the cabinet.

NOTE

To fit the merchandiser through some of the most narrow doorways, you may have to remove the trays. If you do, follow the procedure as outlined on the following page.

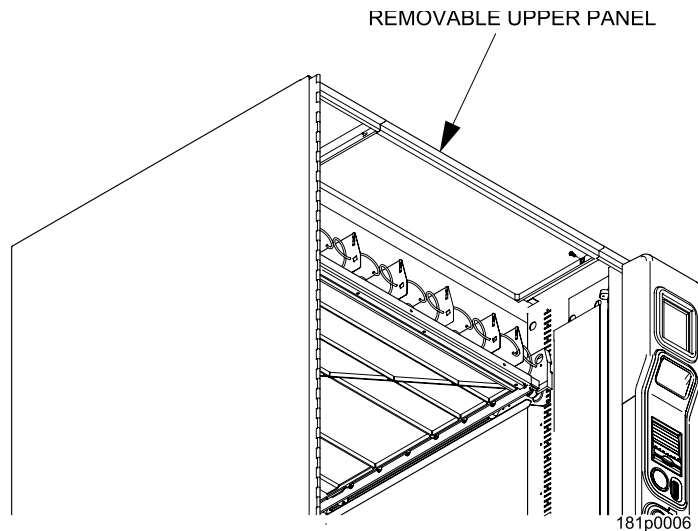

Figure 1

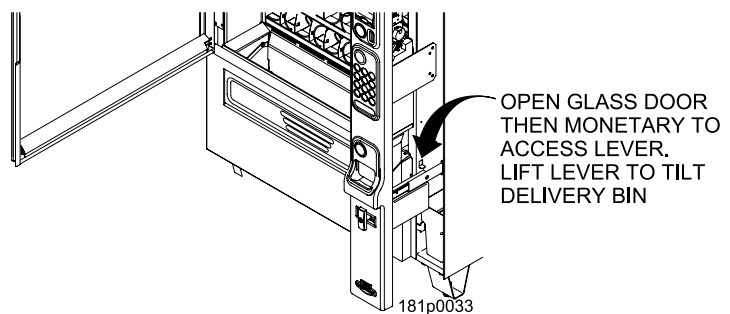

Figure 2

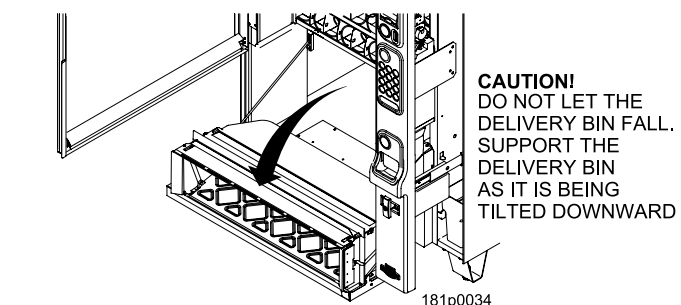

Figure 3

Moving the Merchandiser Through a Narrow Doorway (continued)

CAUTION

Be careful to not damage the tray harnesses when removing trays from the merchandiser.

REMOVING THE TRAYS

1. Unplug the tray harnesses from the PCB mounted inside the slide-out monetary.
 2. Pull the harnesses through the cabinet.
 3. Lift up the front of the tray, so that the stop built into the tray clears the roller, then pull the tray forward and let it return to horizontal position.
- Pull the tray forward in the horizontal position until the back stop on the tray hits the roller, then lift the tray straight up to clear the roller and remove the tray from the merchandiser.

MOVING THE MERCHANDISER THROUGH THE OPENING

1. Open the cabinet door and place it square with the left side of the cabinet.
2. Carefully walk the merchandiser through the opening.

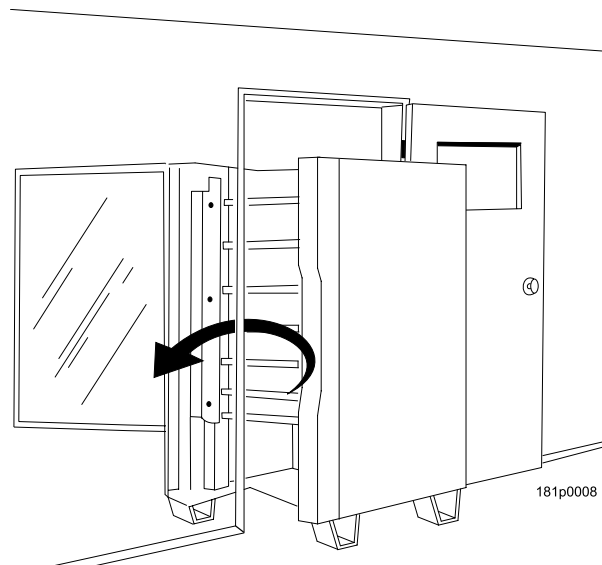

REASSEMBLING THE MERCHANDISER

Replace the upper and lower panels and delivery bin.

If you are not sure that you can fit your merchandiser through the doorway, use the dimensioned drawing to make a cut out in cardboard. The drawing shown has the following removed:

- Delivery bin assembly
- Upper knockout and the anti-theft bar
- Lower knockout
- Main Glass Door
- Trays removed if needed

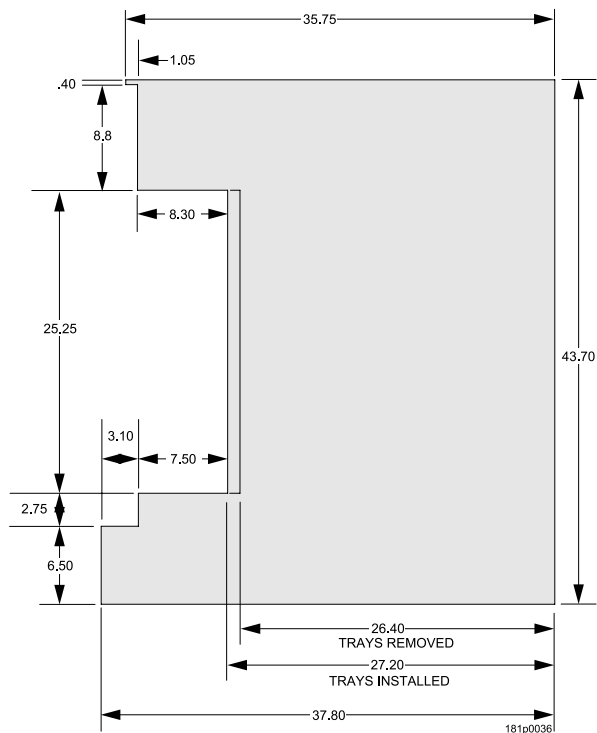

Positioning the Merchandiser

WARNING

This merchandiser is only rated for installation in an *INDOOR* location.

Move the merchandiser to its ***approximate position***. (There are some procedures you need to do before it is in its permanent location.) Plug in your merchandiser and turn the power switch to **ON**.

- You can position this merchandiser anywhere in a bank of machines. It can even be placed on an end flush against a side wall.
- The merchandiser should be located at least one inch away from the back wall.
- There should be enough room in front of the merchandiser for the door to move freely.

Now that you have placed your merchandiser near its permanent location, you need to set up some of the special options you may have..... Go on to the next page and continue with the snack section set up.

Snack Section Set-Up

Placing Trays in the Loading Position

WARNING

The bottom tray will rest on the delivery pan assembly. Take care to avoid striking your fingers against the delivery pan assembly.

1. Lift up the front of the tray, so that the stop built into the tray clears the roller, then pull the tray forward and let it return to horizontal position.
2. Continue pulling the tray forward, then when you are able, tilt the tray downward into the loading position as shown below.

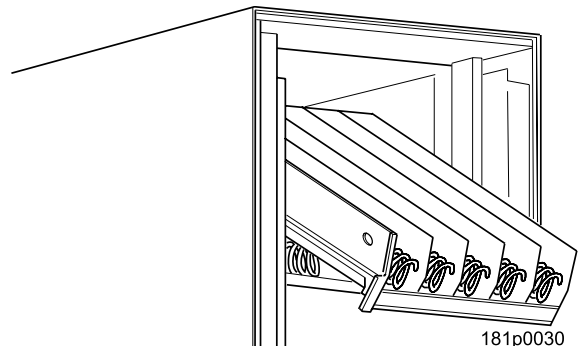
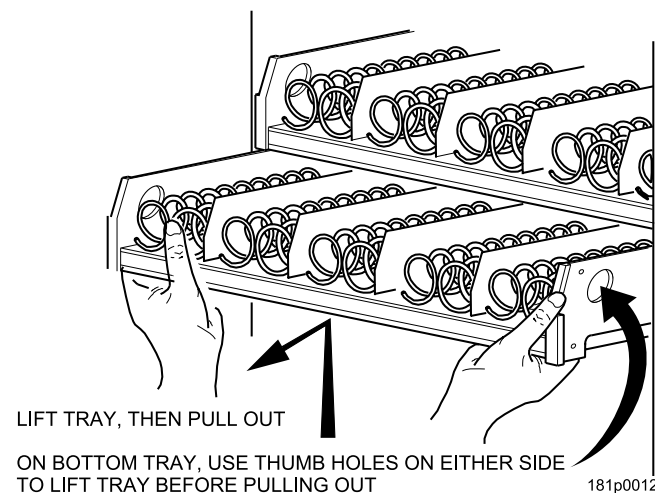

Setting Up Trays to Vend Products

These instructions will guide you through setting up your trays for vending. You will be asked to determine if your tray can physically hold the products you intend to vend. If not, you will be directed to other procedures which will help you get them set up. Follow these nine steps for each tray in your merchandiser:

1. Make sure the tray is in the loading position.
2. Is the column wide enough for the intended product? If so, proceed to the next step. Otherwise, set up your tray to vend wider products (see below, this page). When you're done, return to step 3 in this procedure.
3. Will the products fit between the spiral turns? If so, proceed to the next step. Otherwise, change the spiral.
4. Will the product pass under the tray immediately above? If so, proceed to the next step. Otherwise, reposition the tray and guides.
5. Will the product touch products on either side? If not, proceed to the next step. Otherwise, install a product spacer.
6. Load products in the tray.
7. Return the tray to the vending position.
8. Install the price rolls.
9. Install the selection ID numbers.

Setting Up Trays to Vend Wide Products

The following steps will help you configure your trays to vend wide products. When you have completed the procedures called out in each step, return to the next step in the procedure. When you are done with the entire wide product steps, return to the set-up procedures above.

1. Remove the tray from the merchandiser, unplug harness and place on a flat surface.
2. Based on the size of the product you want to vend, decide how many spiral positions it will occupy. Please remember that the leftmost spiral in the group **must** have an **ODD** ID number (1, 3, 5, etc.) For example, if a product is three spirals wide, the left spiral will be ID number 1, and the right spiral will be ID number 3. Be careful how wide you set up for, because really wide products could get hung up in the delivery door.
3. Remove the column dividers inside the group. In the example of three spiral positions, you would be removing the dividers between spiral ID numbers 1 and 2, and 2 and 3.
4. If your group only consists of 2 spirals, replace the rightmost motor with a spiral bearing and gear, and install a gear on the leftmost motor. Skip to step 8.
5. Remove all spirals in the group except the leftmost spiral.
6. Do one of the following:
 - a. If your group has an **ODD** number of spirals (3, 5, etc.) remove the harnesses from all motors in the group except the leftmost one. To the rightmost motor, connect the harness from the motor immediately to its left.
 - b. If your group has an **EVEN** number of spirals (4, 6, etc.) remove the harnesses from all motors **inside** the group (leave the harnesses connected to the leftmost and rightmost motors).
7. Install a spiral at the rightmost position in your group. Make sure it has the same product capacity and is opposite to the one in the leftmost position.
8. Return the tray to the merchandiser. See *“Installing Standard Trays in the Merchandiser” on page 14*
9. Electronically couple the motors as needed Return to step 3 in the section *“Setting Up Trays to Vend Products” on page 12, above.*

Removing Standard Trays

CAUTION

Be careful to not damage the tray harnesses when removing trays from the merchandiser.

NOTE

Study this procedure before you remove a tray for the first time; while you are holding the tray you will not be able to see this area.

1. Unplug the tray harnesses from the PCB mounted inside the slide-out monetary.
2. Pull the harnesses through the cabinet.
3. Lift up the front of the tray, so that the stop built into the tray clears the roller, then pull the tray forward and let it return to horizontal position.
4. Pull the tray forward in the horizontal position until the back stop on the tray hits the roller, then lift the tray straight up to clear the roller and remove the tray from the merchandiser.

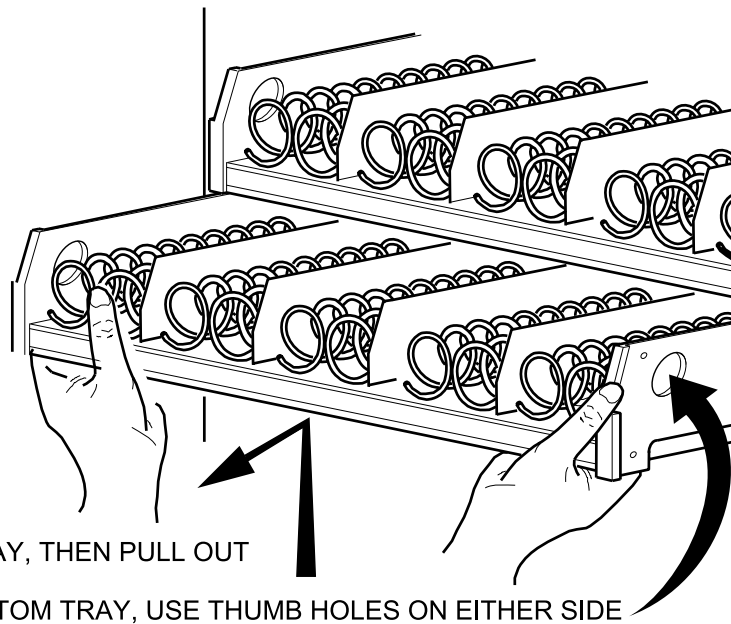

LIFT TRAY, THEN PULL OUT

ON BOTTOM TRAY, USE THUMB HOLES ON EITHER SIDE TO LIFT TRAY BEFORE PULLING OUT

181p0012

Installing Standard Trays

Study this procedure before you install a tray for the first time; while you are holding the tray you will not be able to see this area.

Proceed as follows:

1. Place the back of the tray in the machine so the back tabs on the tray are behind the tray rail rollers.
2. Slide the tray straight back into the machine, insuring that the tray axle stop is engaged in the tray rail. Keep pushing the tray back until it hits the front stop.
3. Lift the front of the tray, so the stop built into the tray clears the roller. Push the tray forward and let it return to horizontal. It will "lock in" to place.
4. Load the tray harnesses into the cabinet, over the tray rail and into the cabinet behind the slide out monetary. Reach through the hole provided in the monetary section and grab the tray harness. Plug the Tray harness into the correct PCB tray harness header.
5. Slide the harnesses up into the round hole provided and secure them with the plastic grommet. Pull the slack of the harnesses back into the cabinet.

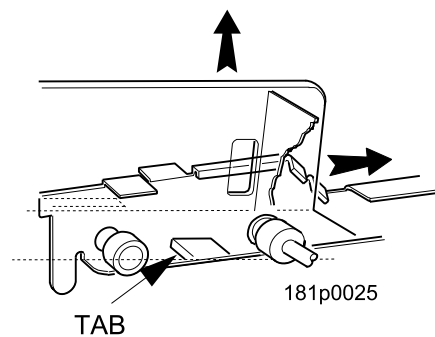
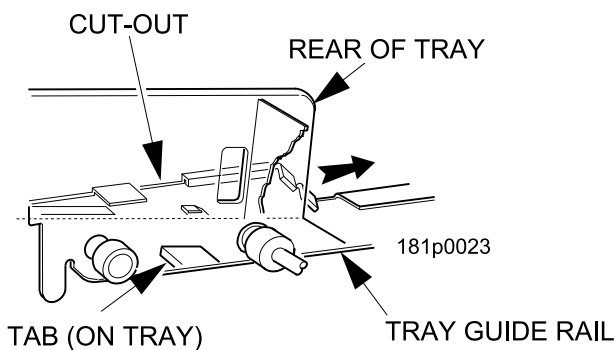
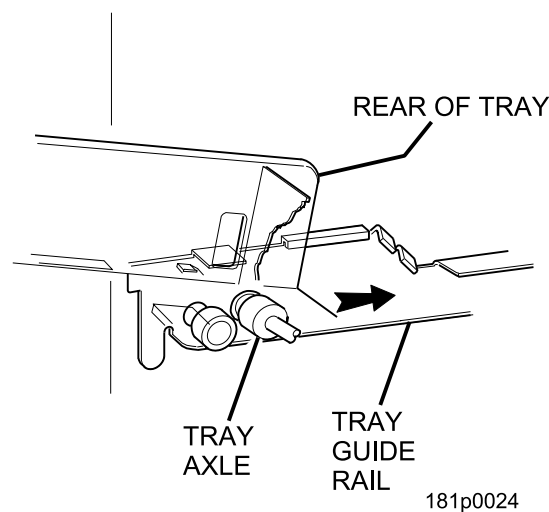
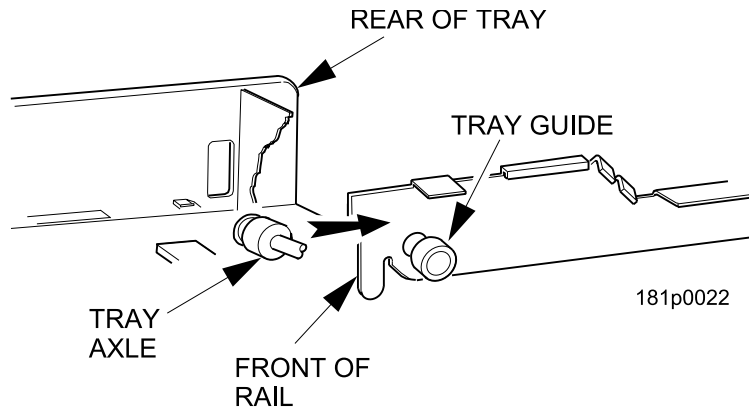

Removing a Bottle Tray

CAUTION

Be careful to not damage the tray harnesses when removing trays from the merchandiser.

1. Remove all product from the tray.
2. Push down on the left and right front tray latches with your thumbs and slide out the tray as far as it will go.
3. Unplug the tray harnesses from the PCB mounted inside the slide-out monetary.
4. Pull the harnesses through the cabinet.
5. Locate a small lever on each side of the tray, where it attaches to the slide. The left lever will be up, the right will be down. Press down on the left lever and up on the right lever.
6. Pull the tray towards you, off of the slides.

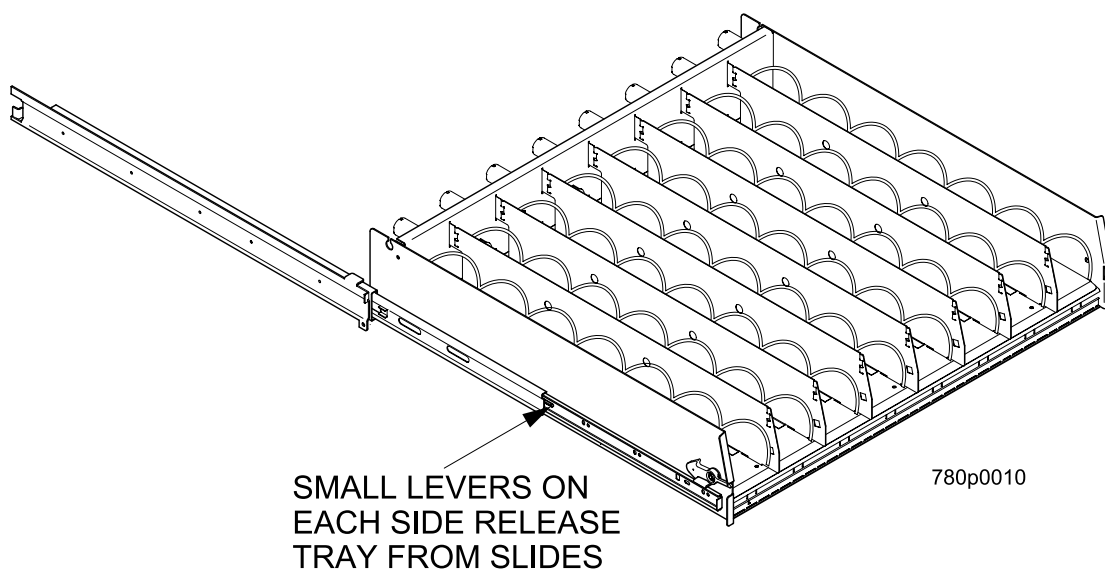

Installing a Bottle Tray

1. Push the slides back into the cabinet until they stop.
2. With the tray held at a 45° angle (with the back higher than the front), align the lower edge of the rail on the tray with the lower edge of the rail in the cabinet on both sides.
3. Slowly raise the shelf to a horizontal position, and push the shelf all the way back into the cabinet.
4. Push down on the left and right hand front tray latches with your thumbs and slide the tray forward against the intermediate stop to test that the tray is correctly engaged.
5. Re-route the harnesses through the cabinet.
6. Plug the tray harnesses into the PCB mounted inside the slide-out monetary.

NOTE

It is much easier to replace a bottle tray if you have assistance lining up the tray rails and slides.

Removing and Installing Column Dividers

1. Push the column divider toward the back of the tray - ①.
2. Lift the column divider clear of the tray - ②.
3. Install the column divider in the reverse order of removal.

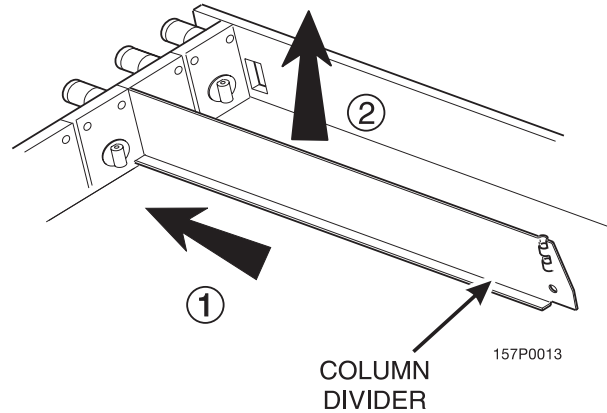

Operating Trays Outside the Merchandiser

The tray harnesses are long enough to remove the trays and set the middle and bottom trays on the floor in front of the merchandiser and the top trays on the top of the merchandiser without unplugging the tray harnesses.

Replacing a Motor With a Spiral Bearing

REMOVING A MOTOR

1. Disconnect the harness from the motor.
(See *“Connecting and Disconnecting a Motor Harness”* on page 17).
2. Remove the spiral. (See *“Removing and Installing Spirals”* on page 18).
3. Remove the spiral coupler. (See *“Removing a Spiral Coupler”* on page 20).
4. Remove the motor. (See *“Removing and Installing a Spiral Motor”* on page 20).

INSTALLING A SPIRAL BEARING

1. Put the gear into position if required in this set-up as shown.
(See *“Installing a Gear”* on page 21).
2. Install the spiral coupler. (See *“Installing a Spiral Coupler”* on page 22).
A coupled spiral does not use a motor.

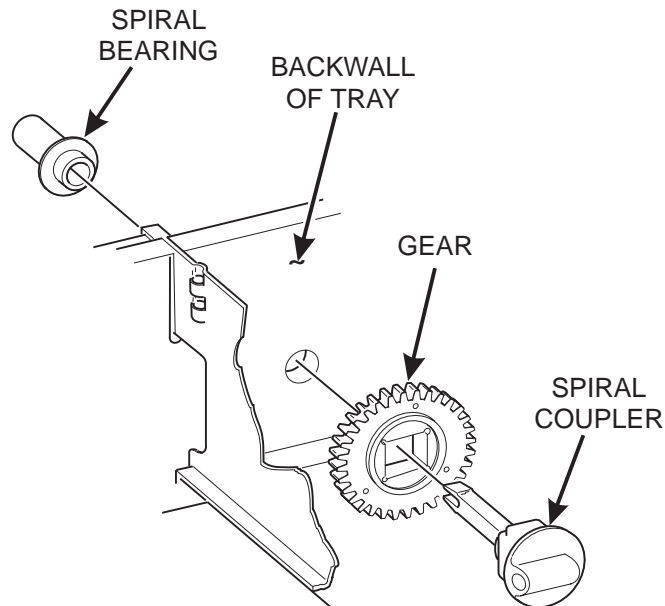

Connecting and Disconnecting a Motor Harness

CAUTION

To avoid breaking the motor circuit board, hold the header on the circuit board whenever connecting or disconnecting a motor harness.

DISCONNECTING A MOTOR HARNESS

1. Pull the harness connector away from the circuit board as shown.
2. Tuck the unused part of the harness out of the way in the trough at the back of the tray.

CONNECTING A MOTOR HARNESS

3. Locate the harness connector for the appropriate tray position.
4. Push the harness connector over the header pins on the motor circuit board as shown.

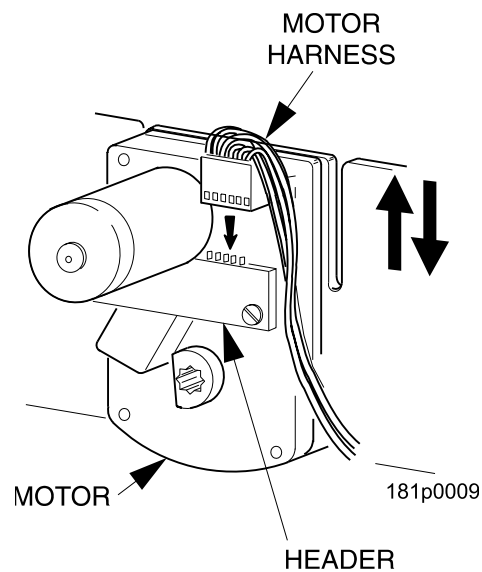

Removing and Installing Spirals

- All spirals are the same diameter:

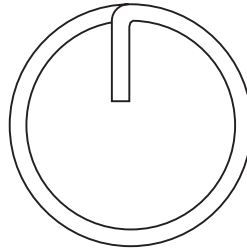

- There are two types of spirals:

COUNTER-CLOCKWISE (left hand)

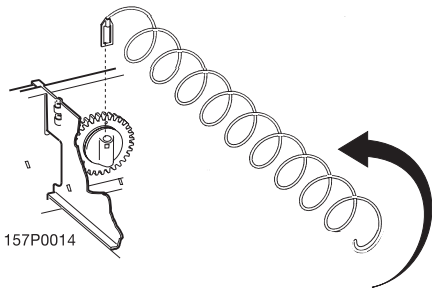

CLOCKWISE (right hand)

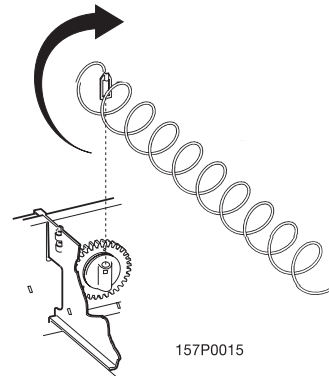

- Spirals are available in the capacities shown below.

MODELS 180, 181, 980, 981				
ITEM CAPACITY OF SPIRAL	PART NUMBER		CLIP COLOR	Dimension Between Coils
	COUNTER CLOCKWISE (LH)	CLOCKWISE (RH)		
5 (Optional)	1477178	1477179	Orange	4.57"
6 (Optional)	1477102	1477104	Purple	3.78"
9 (Optional)	1477153	1477150	Gray	2.46"
11 (Standard)	1477024	1477027	Blue	1.98"
13 (Standard)	1477030	1477033	Yellow	1.65"
15 (Standard)	1477036	1477039	Red	1.41"
17 (Standard)	1477100	1477098	Brown	1.23"
20 (Standard)	1477042	1477045	White	1.02"
25 (Optional)	1477048	1477051	Green	.75"
30 (Optional)	1477054	1477057	Black	.60"
38 (Optional)	1477060	1477063	Orange	.44"
MODELS 448, 449				
4	1707048	1707050	Green	3.66"
5	1707044	1707046	Tan	2.90"
6	1707040	1707042	Purple	2.46"
7	1707057	1707059	Brown	2.23"
8	1707017	1707019	Gray	1.81"
10	1707005	1707007	Blue	1.44"
12	1707009	1707011	Yellow	1.18"
14	1707013	1707015	Red	1.00"
18	1707021	1707023	White	.75"

Removing and Installing Spirals (continued)

REMOVING A SPIRAL

1. Pull forward on the retaining clip and remove the end of the spiral from the spiral coupler as shown.
2. Remove the spiral from the tray.

INSTALLING A SPIRAL

1. Pull the bottom of the retaining clip toward the front of the spiral.
2. Lower the spiral into the tray column and insert the end of the spiral into the spiral coupler as shown.
3. Release the retaining clip.

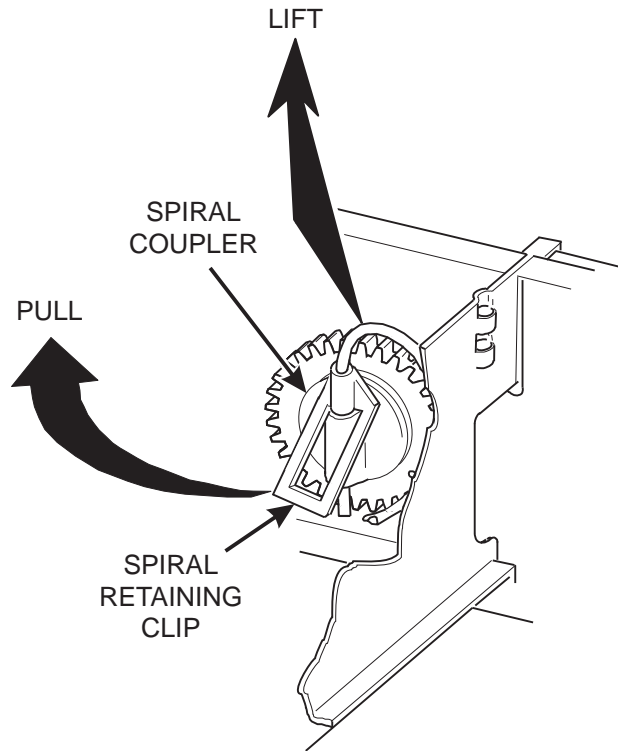

SHOULD I USE A CLOCKWISE OR A COUNTERCLOCKWISE SPIRAL?

1. The type of spiral used is determined by the column position it will occupy in the tray.
2. Refer to the figure below to find the correct spiral type.

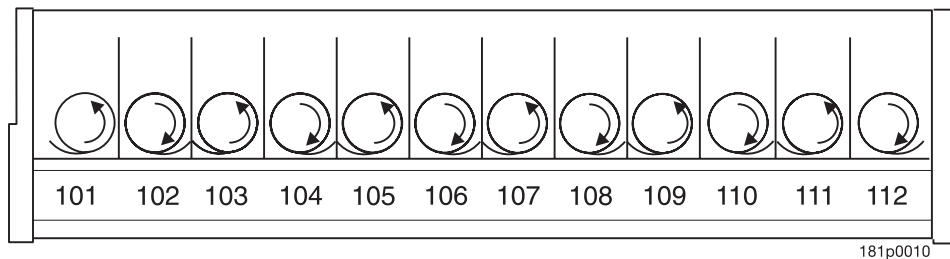

181p0010

Removing a Spiral Coupler

1. Pinch together the prongs on the end of the spiral coupler as shown.
2. Pull the coupler forward in the direction of the arrow as shown.

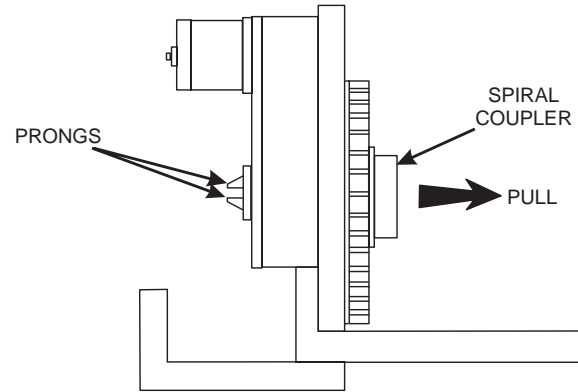

Removing and Installing a Spiral Motor

REMOVING A SPIRAL MOTOR

NOTE

Some steps may already be completed.

1. Remove the tray.
(See "Removing Standard Trays" on page 13).
2. Disconnect the motor harness.
(See "Connecting and Disconnecting a Motor Harness" on page 17).
3. Remove the spiral.
(See "Removing and Installing Spirals" on page 18).
4. Remove the spiral coupler.
(See "Removing a Spiral Coupler" on page 20).
5. Lift the motor clear of the tray.
6. Return the tray to the merchandiser.

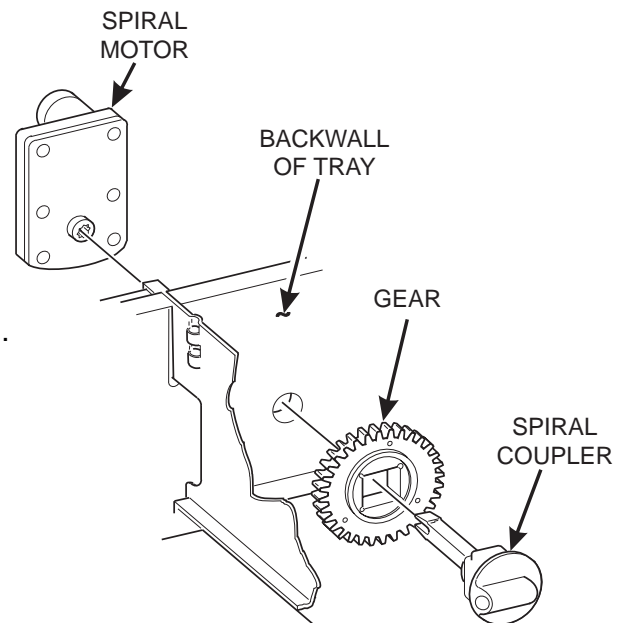

INSTALLING A SPIRAL MOTOR

1. Remove the tray.
(See "Removing Standard Trays" on page 13).
2. Place the motor in the correct position at the rear of the tray as shown.
3. Place a gear in position if required by this set-up.
(See "Installing a Gear" on page 21).
4. Install a spiral coupler in the proper orientation.
(See "Installing a Spiral Coupler" on page 22).
5. Connect the motor harness.
(See "Connecting and Disconnecting a Motor Harness" on page 17).
6. Return the tray to the merchandiser.
See "Installing Standard Trays in the Merchandiser" on page 14

Installing a Gear

WHEN ARE GEARS USED?

- Gears are used to mechanically couple the spirals together.
- This happens whenever you have two spirals and only one motor for vending a selection.

WHERE ARE THE GEARS PLACED?

- The gear is placed between the back of the tray and the spiral coupler.

HOW IS THE GEAR ORIENTED?

- There are two possible orientations for the gear:

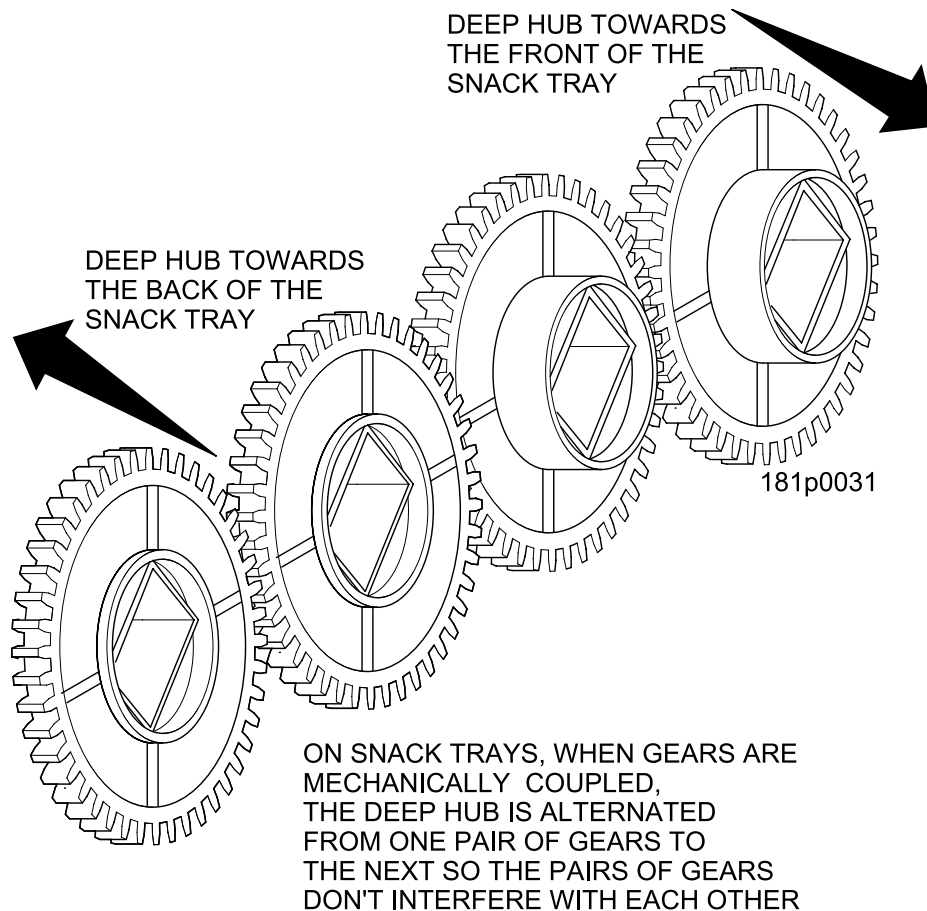

- There are two rules to follow when orienting gears:
 - RULE 1** – The gears for single spiral selections next to each other cannot use the same gear orientation.
 - RULE 2** – All gears for a single coupled or double spiral selection must use the same orientation.

Installing a Spiral Coupler

Place the gear in position if one is required for this set-up. (See "Installing a Gear" on page 21.)

WHEN USED WITH A MOTOR

Hold the motor in place and push the spiral coupler through the motor gear box until it clicks into position. Be sure the spiral couplers are oriented as shown below:

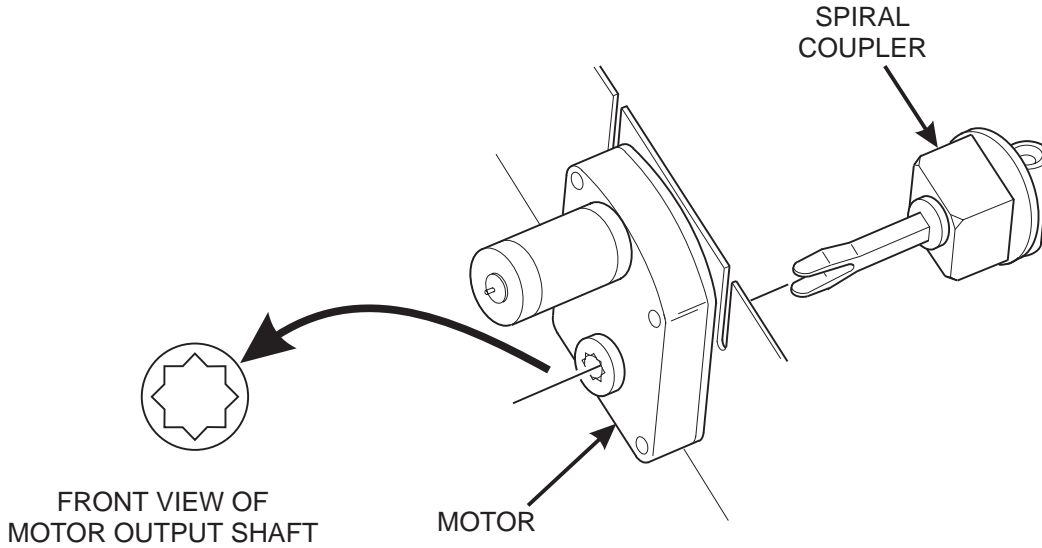

NOTE

The motor output shaft opening contains eight facets to allow the spiral coupler to be installed in any one of eight positions.

SPIRAL COUPLER ORIENTATION

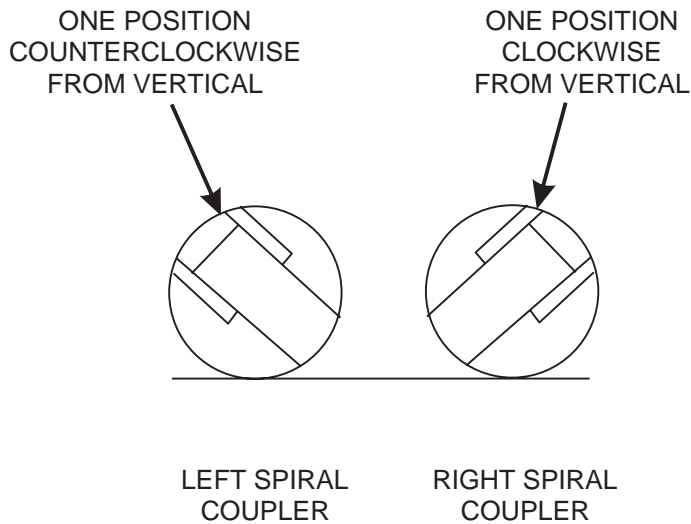

AS VIEWED FROM FRONT OF TRAY

Installing a Spiral Coupler (continued)

WHEN USED WITH A COUPLER BEARING

Hold the coupler bearing in place and push the spiral coupler through the bearing until the coupler clicks into position. Be sure the coupler is in the proper orientation as shown.

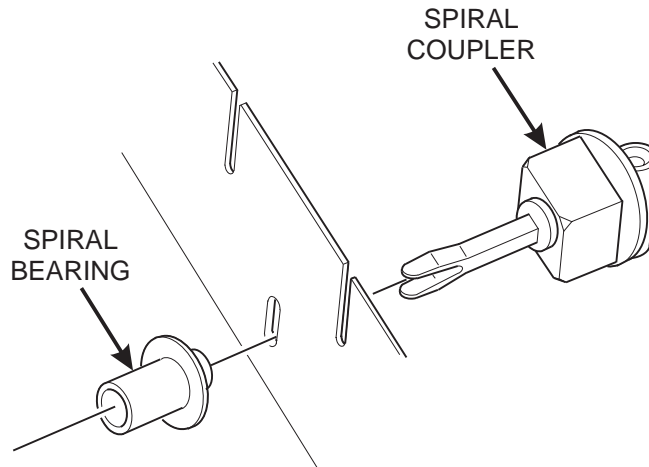

Moving Trays Up or Down

This merchandiser can be adjusted to vend taller products. Some guidelines must be followed:

- Keep in mind that when you increase the product height available to a tray by lowering it, you will be decreasing the product height available to the tray below.
- If a tray is in the lowest position, the tray below it should not be in the highest position.
- If a tray is in the highest position, the tray above it should not be in the lowest position.
- You will need to experiment with various tray positions to get the best results for your products.

Proceed as follows:

1. Remove the tray from the merchandiser. (See *“Removing Standard Trays”* on page 13).
2. Remove the screw that secures the right tray guide rail to the front guide mounting channel as shown.
3. Tap up on the guide rail and unseat the guide rail tabs from the channel slots.
4. Pull the guide rail away from the front and rear guide mounting channels.
5. Move the guide rail to the desired position.
6. Insert the guide rail tabs into the mounting channel slots as shown.
7. Tap down on the guide rail to seat the tabs in the channel slots.
8. Replace the screw that secures the guide rail to the front guide mounting channel.
9. Repeat steps 2 through 8 for the left guide rail.
10. Return the tray to the merchandiser. See *“Installing Standard Trays in the Merchandiser”* on page 14

Moving Trays Up or Down (continued)

- 11. Load products into the trays, and perform test vends. Make sure the trays don't interfere with the products you are vending, and that all products vend properly.

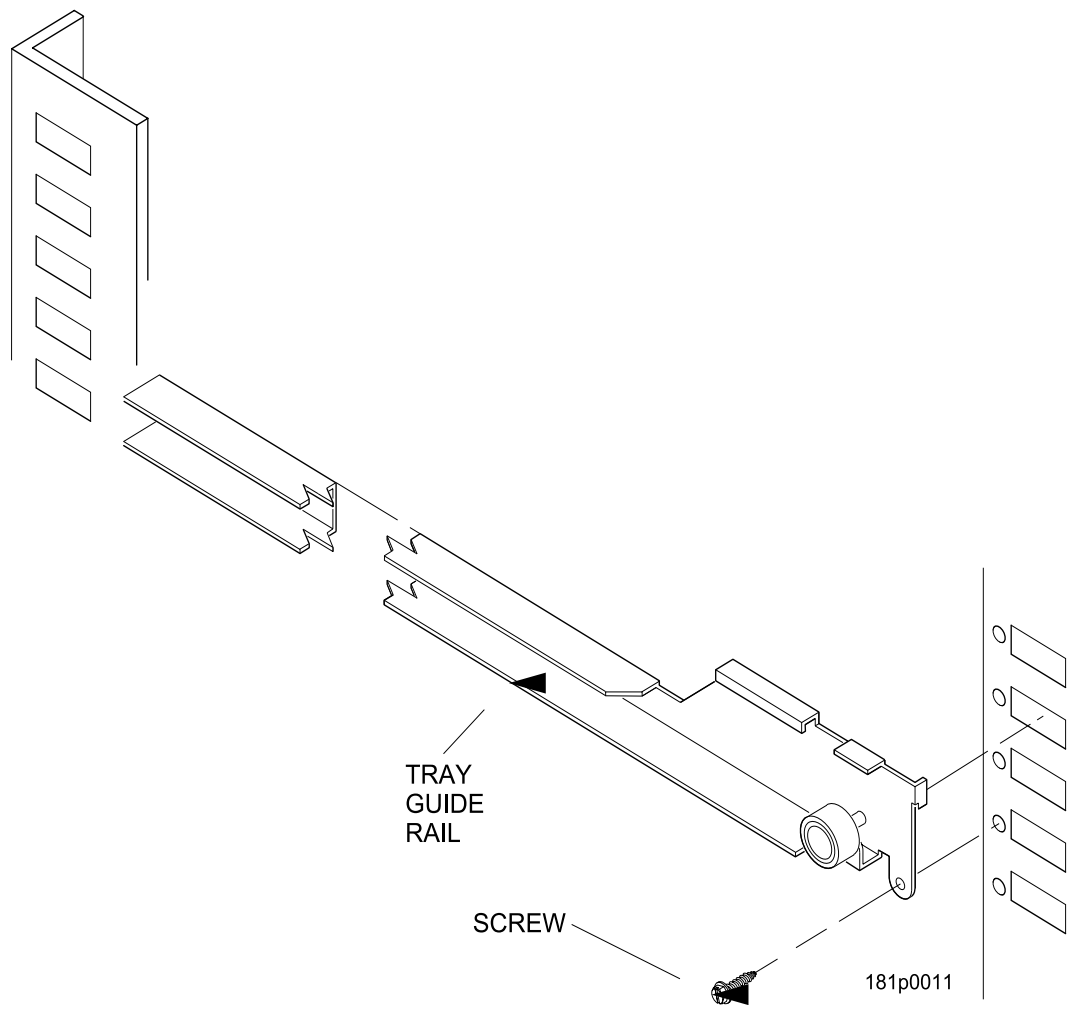

Installing and Removing Product Spacers

INSTALLING A PRODUCT SPACER

- The product spacer will keep a tall, narrow product upright.
- Shown below are spacers and column dividers on both deep and shallow trays.
- Insert the product spacer onto the column divider as shown.

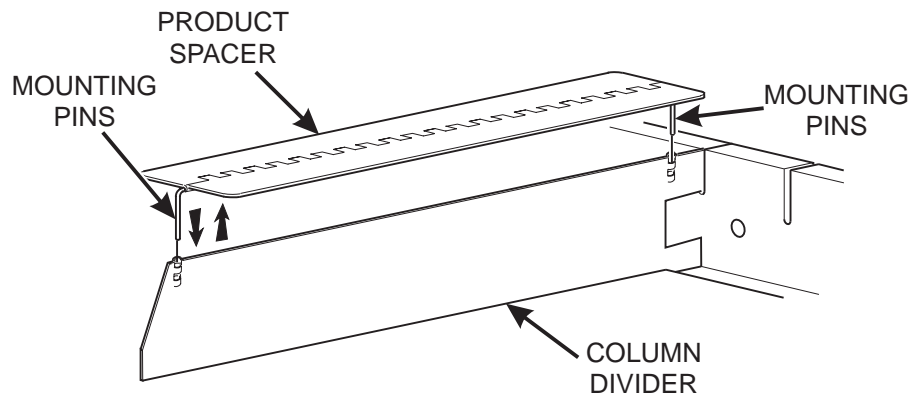

REMOVING A PRODUCT SPACER

- Pull the product spacer mounting pins from the column divider.

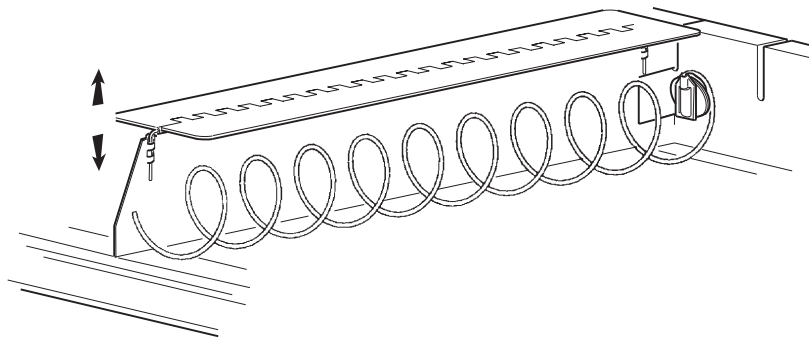

Loading Trays with Product

Table 1: SPIRAL CAPACITY COLOR CODES

The color of the spiral coupler (the little plastic tab attached to the rear of the spiral) will tell you how many products will fit in the spiral (see the tables at right).

NOTE

Another way to determine spiral capacity is to count the spaces in the spiral.

MODELS 180, 181, 980, 981			
SPIRAL CAPACITY	SPIRAL COUPLER COLOR	SPIRAL CAPACITY	SPIRAL COUPLER COLOR
6	Purple	20	White
11	Blue	25	Green
13	Yellow	30	Black
15	Red	38	Orange

MODELS 448, 449	
SPIRAL CAPACITY	SPIRAL COUPLER COLOR
8	Grey
10	Blue
12	Yellow
14	Red
18	White

LOADING TRAYS WITH PRODUCTS IN GENERAL

- See “*PRODUCT PUSHER USAGE*” on page 28 for spirals with capacity of 11, 13, or 15.
- See “*SPIRAL WALL RETAINER USAGE*” on page 27 for spirals with capacity of 20, 25, 30, or 38.
- Begin loading products at the front of the tray and work toward the back. Position the product so the package rests on the tray. DO NOT force a product into a spiral.
- If the fit is too tight or too loose, change the spiral size. (See “*Removing and Installing Spirals*” on page 18).
- Be sure there are no empty positions between products in each spiral.

SPECIAL CONSIDERATIONS

Bagged Products Position package upright, then push the tops slightly toward the rear of the tray. Also, (see “*PRODUCT PUSHER USAGE*” on page 28).

Thin Packages Position the package upright. Also, (see “*SPIRAL WALL RETAINER USAGE*” on page 27).

Kit Kat The two right-most columns of the candy tray are designed to accept the Kit Kat candy bar.

WARNING

When set to “Ambient” or “Chilled Snack” this merchandiser does not have a health control circuit. It is not approved for the vending of perishable food items in these modes.

Loading Trays with Product (continued)

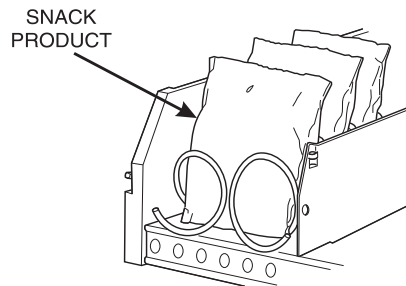

CORRECT LOADING OF SNACKS

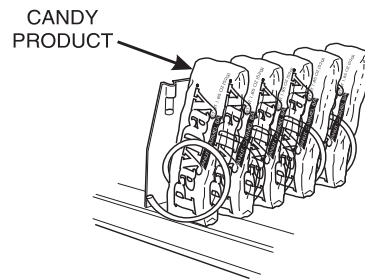

CORRECT LOADING OF CANDY 157P0035

SPIRAL WALL RETAINER USAGE

A spiral wall retainer serves to compress the spiral and make it act like a spring to more forcefully eject a product. Do some test vend and use a spiral wall retainer when a product does not readily leave the spiral.

- Use a spiral wall retainer in the following cases:
 - The spiral has a capacity of 20, 25, 30, or 38.
 - The product is thin.
 - The product is on a candy tray.
- The spiral wall retainer can also be used with other spirals and types of products.
- The spiral wall retainer is installed near the front of the column divider.

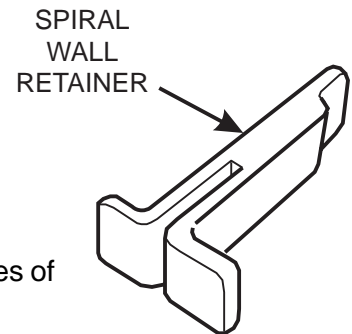

There are two ways to install the spiral wall retainer.

	RETAINER ORIENTATION	
	A	B
COLUMN DIVIDER BETWEEN THESE POSITIONS	0 and 1	1 and 2
	2 and 3	3 and 4
	4 and 5	5 and 6
	6 and 7	7 and 8
	8 and 9	

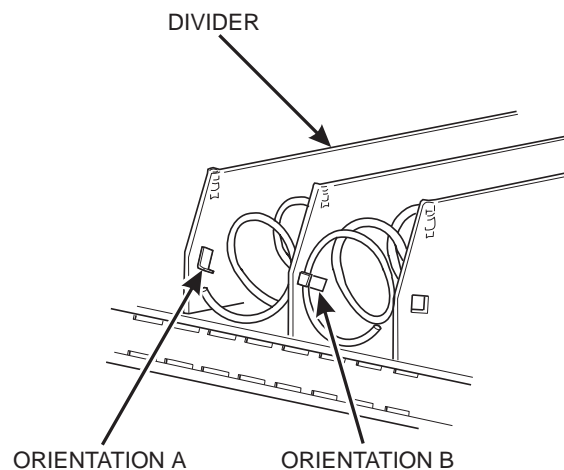

- To install a spiral wall retainer, insert the retainer in the square slot near the front of the column divider.
- The spiral wall retainer must be removed in two cases:
 - A Kit Kat bar loaded into either of the two right hand positions of a tray will not clear the retainer on the column divider between the two positions.
 - A product pusher will catch on a retainer in *ORIENTATION A*.

Loading Trays with Product (continued)

PRODUCT PUSHER USAGE

The product pusher will give the top of a product an extra tilt to help it fall into the delivery pan.

Use a product pusher in the following cases:

- The spiral has a capacity of 15, 13, or 11.
- The package is non-rigid like bagged peanuts.

The product pusher can also be used with other spiral and types of products.

A bag of product pushers has been shipped with the merchandiser. Additional product pushers are available from the National Vendors part department. To use a product pusher, snap it on the spiral as shown. You can adjust the product pusher by moving it around on the spiral to achieve the best vending results.

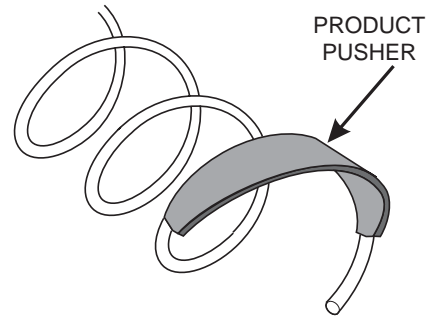

PREPARING THE MERCHANDISER FOR VENDING "LUNCH BUCKET"

Because of the weight and shape of the package, National Vendors recommends that this product be vended only from the bottom tray.

To vend this product, two adjacent positions must be coupled together.

(See "Installing a Gear" on page 21 for mechanical coupling directions and see "Couple Motors" on page 108 for electrical coupling directions).

The left spiral coupler should be installed one position counterclockwise from the vertical position.

The right spiral coupler should be installed one position clockwise from the vertical position.

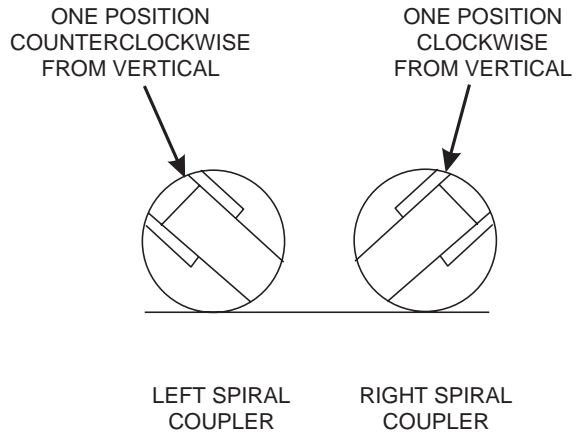

AS VIEWED FROM FRONT OF TRAY

Replace the current spirals with six-count spirals. These are available from the National Vendors parts department. (See "Removing and Installing Spirals" on page 18).

A pad can be installed in the bottom of the delivery pan to quiet and cushion product delivery. This part is available from the National Vendors parts department.

Load "Lunch Bucket" products as shown below:

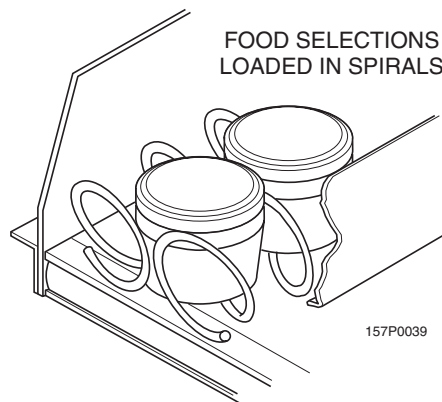

Proper Loading of "Lunch Bucket"

Loading Trays With Product (continued)

PREPARING THE MERCHANDISER FOR VENDING "TOP SHELF"

National Vendors recommends that this product be vended from a candy tray.

Move the tray so the package can be loaded standing on its left or right edge.

(See "Hold the coupler bearing in place and push the spiral coupler through the bearing until the coupler clicks into position. Be sure the coupler is in the proper orientation as shown." on page 23).

The following steps must be completed for three adjacent positions on the tray:

NOTE

The left-most position in the group of three must be an even numbered position.

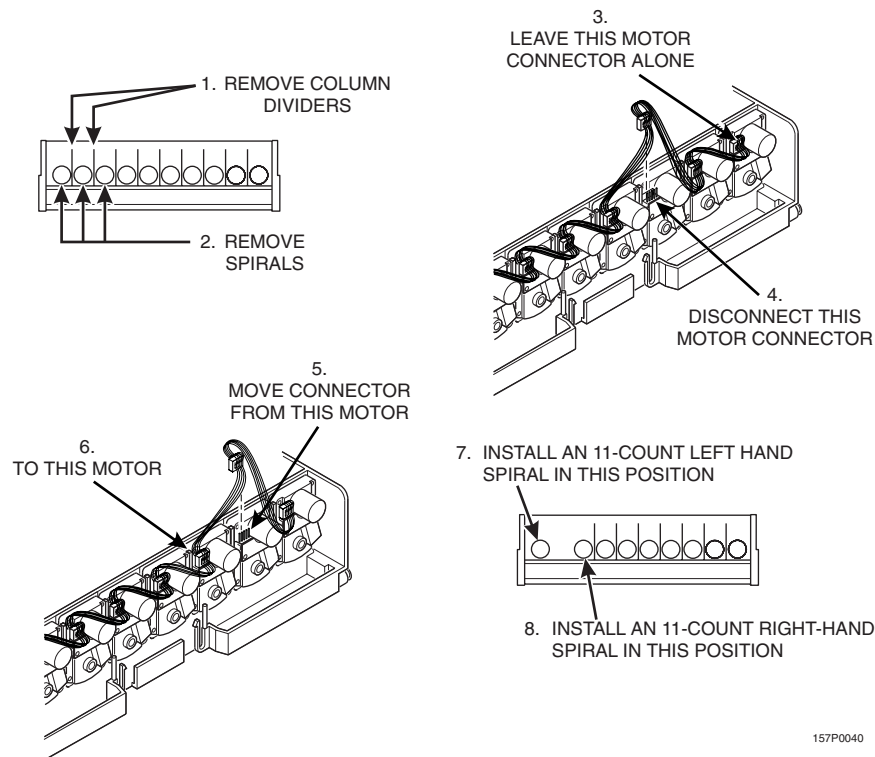

NOTE

If the motor harness you disconnected in step 5 does not reach, use the motor skip harness, P/N 1599024, available from the National Vendors Parts Department.

Couple the left motor to the right motor. (See "Couple Motors" on page 108.)

Loading Trays With Product (continued)

Load the "Top Shelf" products as shown below:

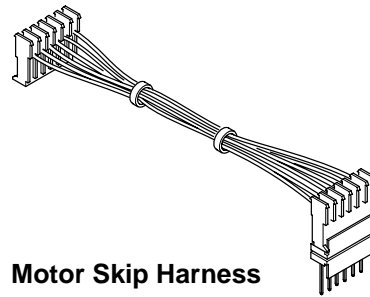
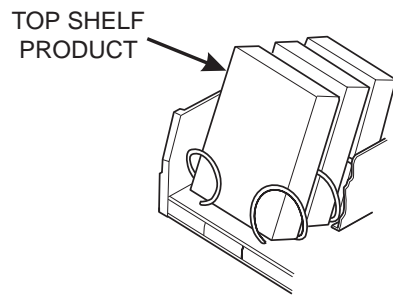

167p002f

Returning the Trays to the Vending Position

1. Lift the tray until it is parallel to the floor as shown.

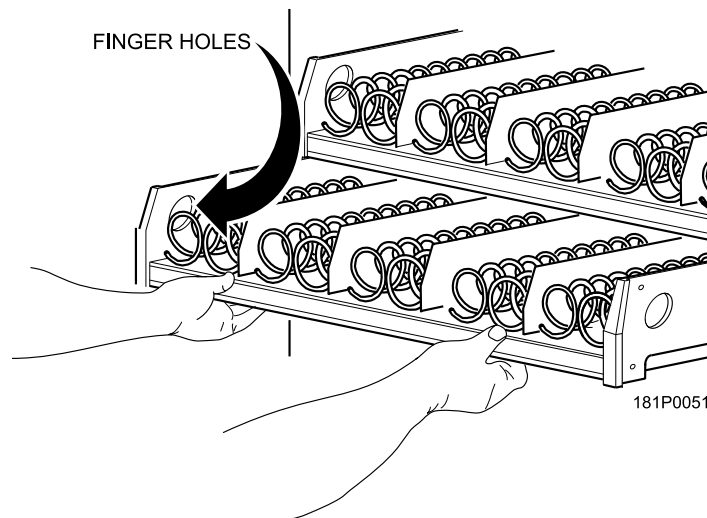

TO AVOID PINCHING WHEN REMOVING TRAY,
POSITION YOUR HANDS TOWARDS
THE CENTER OF THE TRAY . LIFT AND PULL OUT.

ON THE BOTTOM TRAY, USE THE FINGER HOLES
FOUND ON BOTH SIDES OF THE TRAY TO LIFT AND
PULL OUT FROM THE INSIDE OF THE TRAY.

2. Push the tray toward the back of the cabinet.

Installing and Setting Price Labels

- Price rolls are printed on coiled-up strips as shown in this example. If you use another type of currency, you will find the appropriate price rolls in the plastic bag that contained this manual.
- The price roll installed indicates .30 to 2.35 in .05 increments.
- Remove the price rolls as required, and install the appropriate one(s) for your currency.

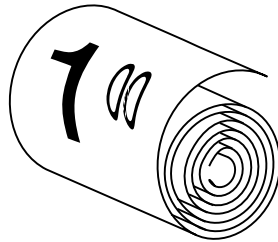

181p0019

- If the product to be vended is to cost more than \$2.35, install per this example:
 1. Insert the dollar roll in the left-most pair of slots as shown if the price is \$1.00 or more.
 2. Insert the cents roll in the center pair of slots as shown.
 3. The low-number end of the roll goes in the top slot and the high-number end of the roll goes in the bottom slot.

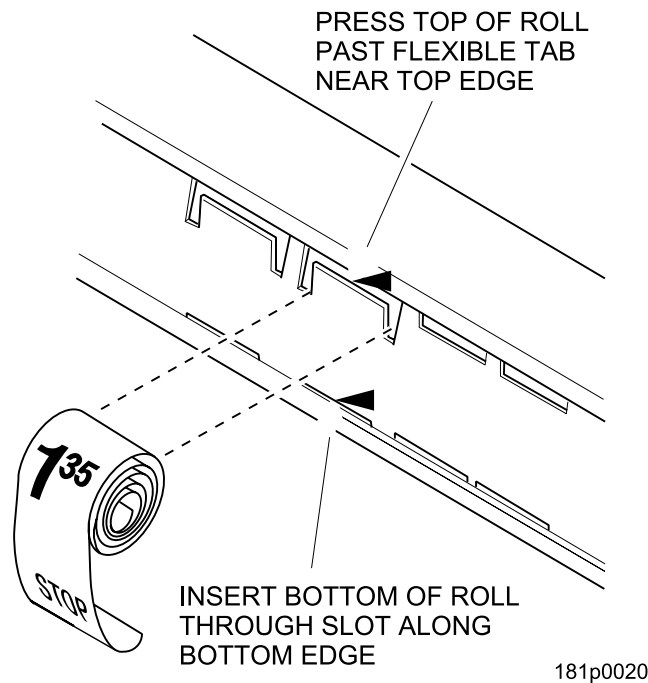

Installing and Setting Price Labels (continued)

ADJUSTING THE PRICE ROLL

You can set selection prices within the following range:

Minimum price	\$.00
Maximum price	\$12.95
Increment	\$.05

Use your thumb as shown to move each price roll up or down as needed to set the desired price.

NOTE

You will see the word *STOP* near either end of the roll.

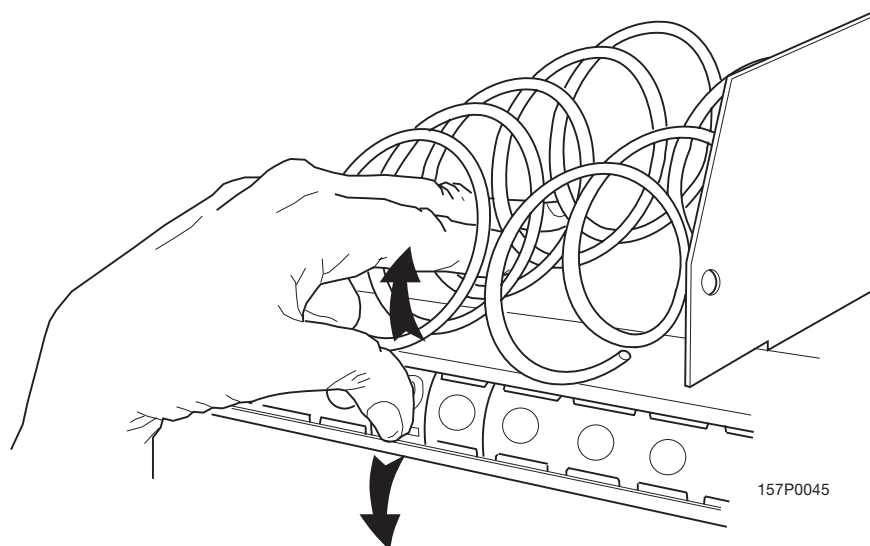

Installing Selection ID Labels

Selection ID numbers are printed on clear plastic sheets. You will find these in the plastic bag that contained this manual. You will need to separate them along the scored lines between the selections.

CAUTION
BE CAREFUL when doing this, because it is easy to split the labels.

TO INSTALL SELECTION ID NUMBERS

1. Press together the two long edges of the selection ID label.
2. Snap the selection ID label into position on the front of the tray as shown.

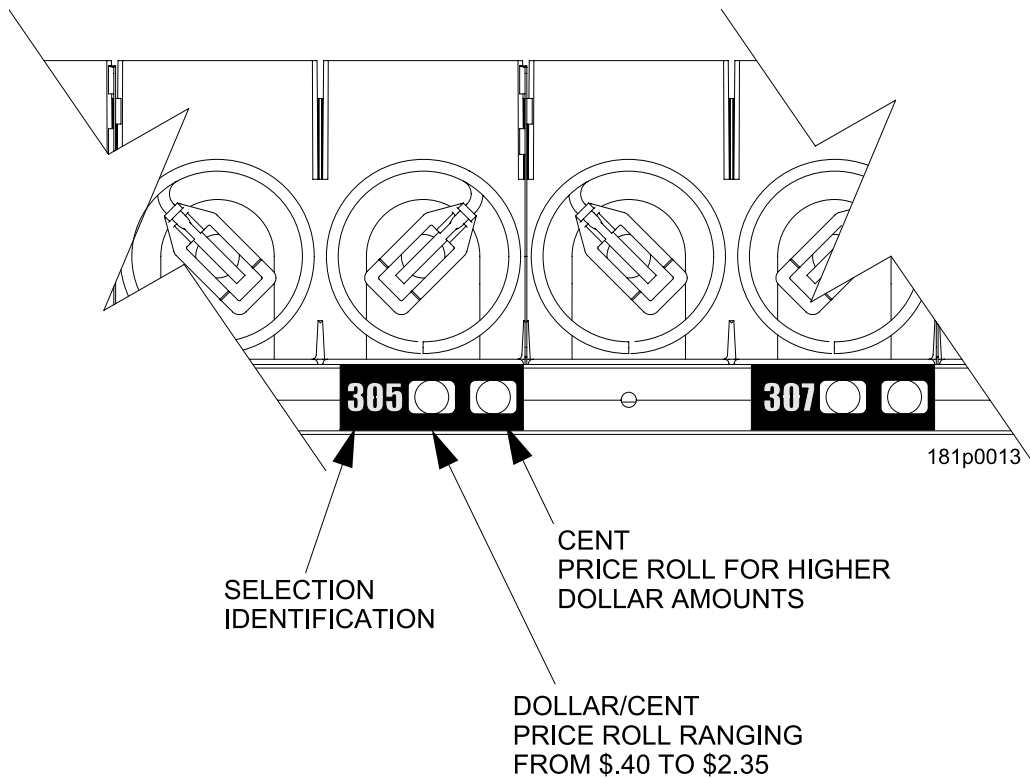

Installing Selection ID Labels (continued)

WHICH ID LABEL GOES WITH WHICH SELECTION?

See the figures below for snack and candy tray positions.

Table 1: Motor Position

TOP TRAY	TRAY 100	101	102	103	104	105	106	107	108	109	110	111	112
	TRAY 200	201	202	203	204	205	206	207	208	209	210	211	212
BOTTOM TRAY	TRAY 300	301	302	303	304	305	306	307	308	309	310	311	312
SQUAT TRAY	TRAY 700		702	703	704	705	706	707	708	709	710	711	

NOTE

The example above shows a 4-tray merchandiser.
Some merchandisers can have up to 7 trays.

EXAMPLE OF A BASIC SNACK TRAY ID LABEL TO USE

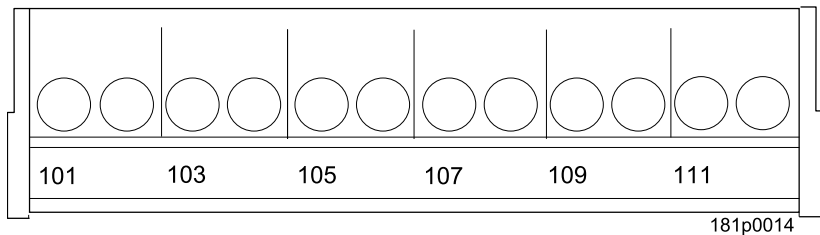

181p0014

EXAMPLE OF A BASIC CANDY TRAY ID LABEL TO USE

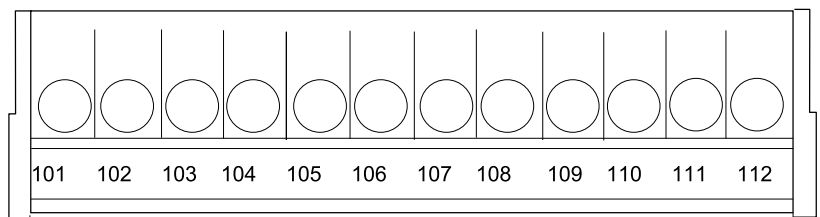

181p0015

EXAMPLE OF A BASIC SQUAT TRAY ID LABEL TO USE

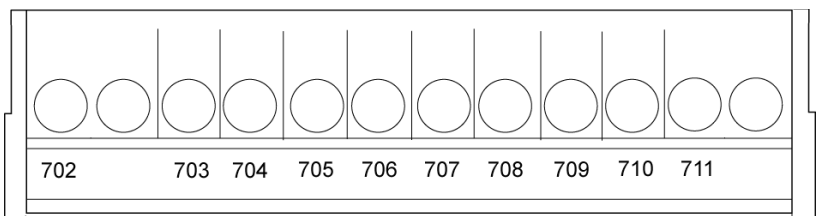

181p0015a

Final Installation

Move the merchandiser to its *final position*

- You can position this merchandiser anywhere in a bank of machines. It can even be placed on an end flush against a side wall.
- There should be enough room in front of the merchandiser for the door to move freely.

WARNING

This merchandiser is only rated for installation in an indoor location.

Leveling the Merchandiser

Using a spirit level, adjust the legs until the cabinet is level from side to side and front to back.

NOTE

A slight slope from front to back will improve the draining of condensate from merchandisers with refrigerating units. When the merchandiser is part of a bank of machines, level it in reference to the other machines. After leveling is complete, check that the door operates easily.

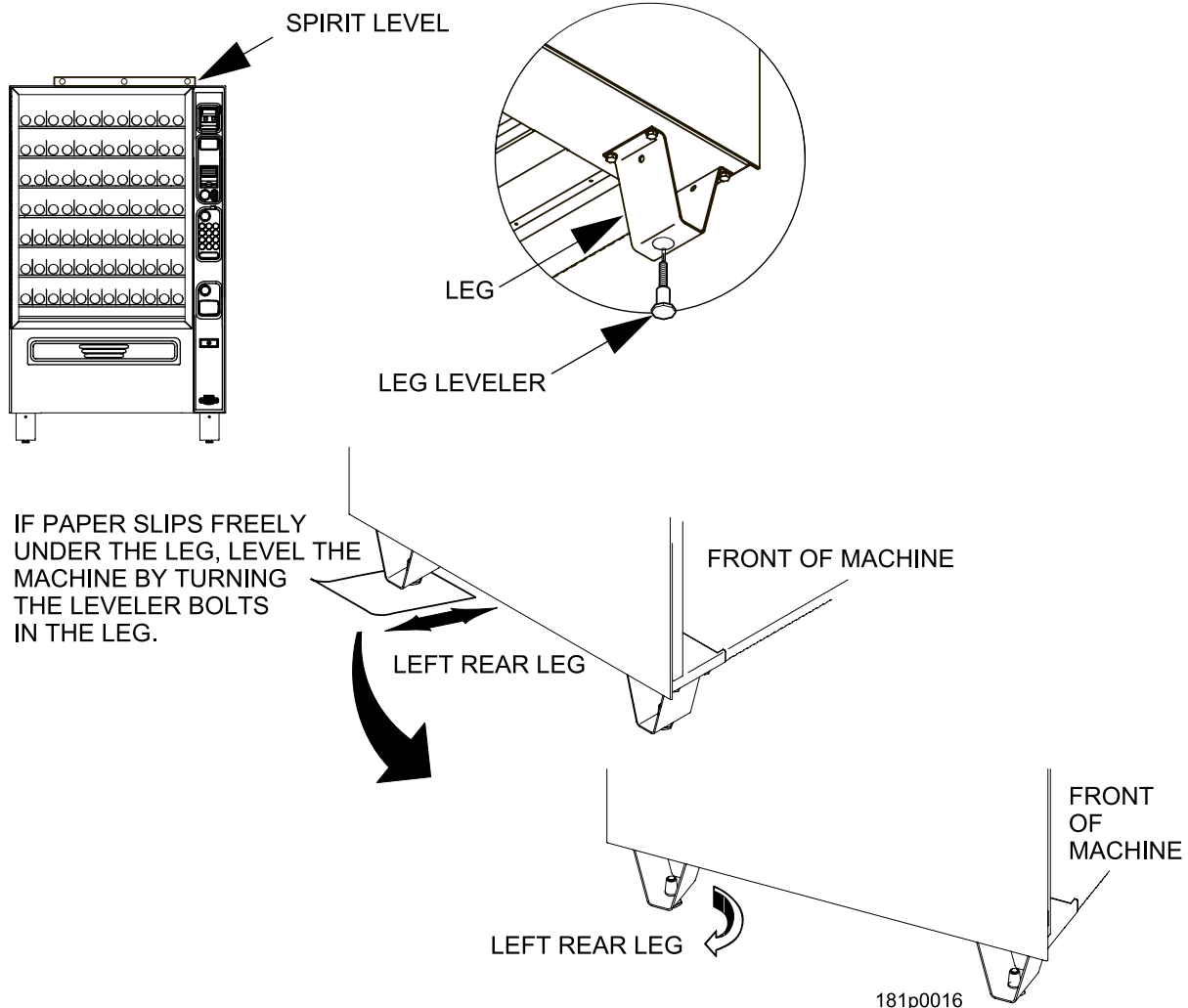

Installing the Base Plate

Refer to the figure below while completing the following procedures:

1. Insert the long arms of the slides into the holes in the legs.
2. Insert and secure a cotter pin through the hole in the back of each of the slides.
3. Push the base plate toward the merchandiser cabinet. The front tabs of the base plate brackets should seat in the notches in the long arms of the slides.

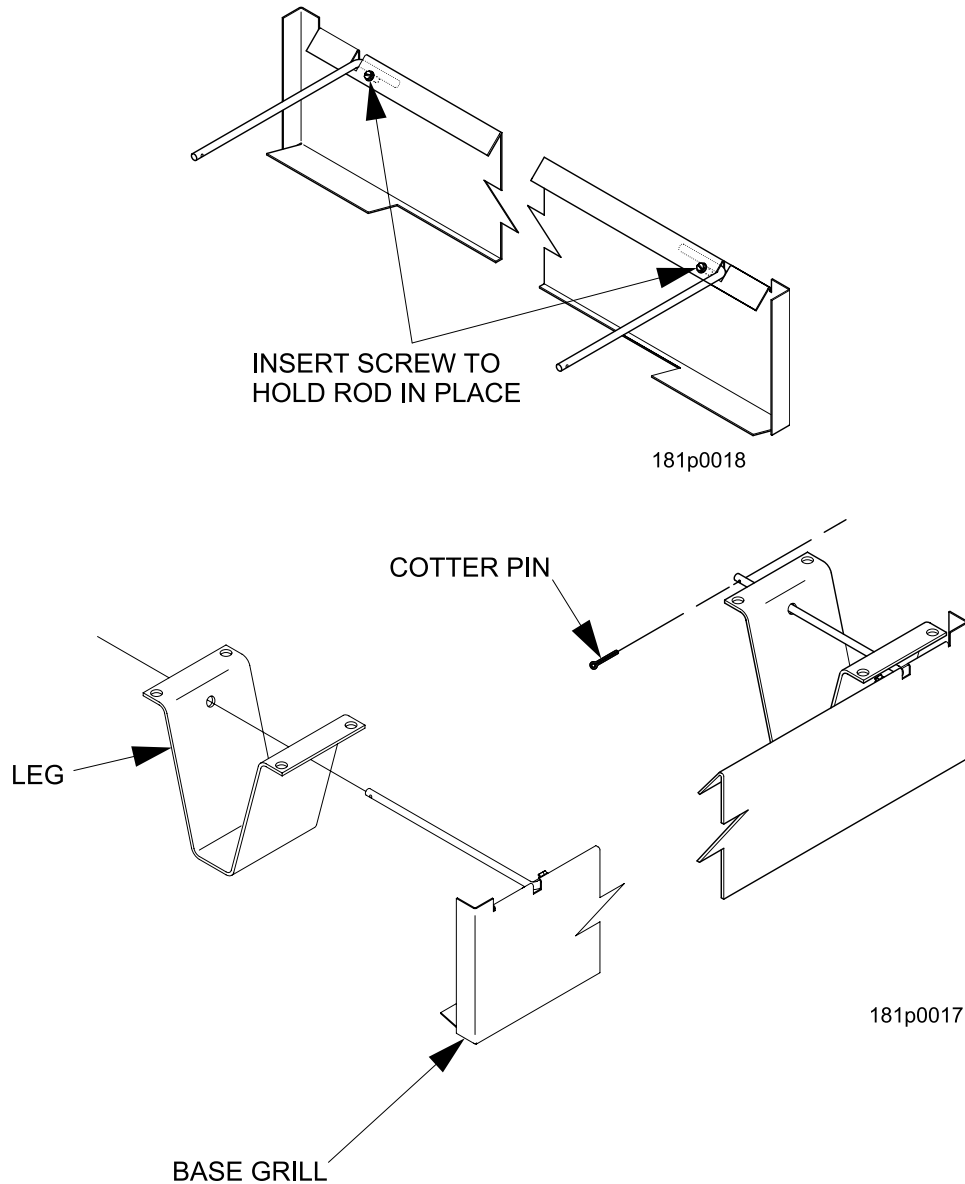

WARNING!

Do not use this base plate on Models 448 or 449!
Doing so could result in damage to the refrigeration unit.

Setting Up and Loading the Coin Mechanism

Once you arrive at the steps that tell you how to setup your coin mechanism, please perform the following steps:

CAUTION

The main power switch must be turned OFF before you go any further!

1. If not already plugged in, plug the power cord into the electric outlet and turn ON the main power switch.
2. Perform the steps outlined in the procedure to "Select the Coin Mechanism" on page 139

TriTeq Lock Information

If your machine has a TriTeq lock installed in it, please call 1-410-223-2140 for all service issues.

Final Checkout

Now, you have connected your merchandiser to the utilities, placed it in its final location, loaded it with products, and set the prices. Before you lock the door and move on, you should check to see if your merchandiser will vend products. In case of problems, perform the operational readiness checks beginning on this page.

Operational Readiness Check

1. Perform test vends on all selections. (See *“Test Vend a Selection”* on page 82.)
2. Do any of the snack or candy products catch on the tray and fail to vend? If not, skip to step 3. If so, perform the following procedures on the affected areas until all products vend properly:
 - a. Install and/or adjust a product spacer. (See *“Installing and Removing Product Spacers”* on page 25.)
 - b. Install a product pusher. (See *“PRODUCT PUSHER USAGE”* on page 28.)
 - c. Install and/or remove spiral wall retainers. (See *“SPIRAL WALL RETAINER USAGE”* on page 27.)
 - d. Perform the appropriate spiral anti-hang-up procedure(s) (See the *“Spiral Indexing Procedures”* on the next page.)
3. Test the operation of the coin mechanism (See *“Setting Up and Loading the Coin Mechanism”* on page 38 for the proper procedure.)
4. Test the operation of the bill validator. (See *“Testing the Bill Validator”* on page 41.)
5. Return all test vended products to the trays.

Spiral Indexing Procedure (One Spiral, One Motor)

The spiral indexing procedures involve rotating spirals one position at a time until the product vends properly.

1. Home all the motors (see *"Homing the Motors - Motor Status Detail"* on page 86.)
2. Remove the affected spiral.
3. Is the coupler in the proper position?
NO - Move the coupler to the position as shown in *"Installing a Spiral Coupler"* on page 22. Go to step 4.
YES - Move the coupler to the next clockwise position (if it's on a right-hand motor), or the next counterclockwise position (if it's on a left-hand motor). Go to step 4.
4. Replace the spiral.
5. Perform a test vend (see the previous page).
6. Did the product hang up?
NO - You're finished. Continue to test vend the remaining selections until everything works properly.
YES - Go to step 7.
7. Did you previously move the coupler to the next clockwise or counterclockwise position?
NO - Move the coupler to the next clockwise position (if it's on a right-hand motor), or the next counterclockwise position (if it's on a left-hand motor). Return to step 6.
YES - Return to step 2 in the operational readiness check and try another procedure. Do not move the coupler again.

Spiral Indexing Procedure (Two Spirals, One Or Two Motors)

The spiral indexing procedures involve rotating spirals one position at a time until the product vends properly.

1. Home all the motors (see *"Homing the Motors - Motor Status Detail"* on page 86.)
2. Remove the left hand spiral of the affected pair.
3. Is the coupler in the proper position?
NO - Move the coupler to the position as shown in *"Installing a Spiral Coupler"* on page 22. Go to step 4.
YES - Move the left coupler to the next counterclockwise position. Go to step 4.
4. Replace the left hand spiral.
5. Remove the right hand spiral, spiral coupler, and gear (if used) of the affected pair as a unit.
6. Rotate this unit until the right hand spiral mirrors the position of the left hand spiral.
7. Replace the right hand spiral, spiral coupler, and gear (if used).
8. Perform a test vend (see *"Test Vend a Selection"* on page 82.)
9. Did the product hang up?
NO - You're finished. Continue to test vend the remaining selections until everything works properly.
YES - Go to step 10.
10. Did you previously move the left hand coupler to the next counterclockwise position?
NO - Remove the left hand spiral of the affected pair. Turn the left spiral coupler to the next counterclockwise position. Return to step 4.
YES - Return to step 2 in the operational readiness check and try another procedure. Do not move the coupler again.

Testing the Bill Validator

1. Insert a \$1 bill into the validator.
2. Push the coin return button.
 - If Change without Purchase (See “Set Change Without Purchase” on page 141.) is set less than \$1.00 and the bill is stacked - no money is returned - you must make a selection in order to receive any change. Proceed to step 3.
 - If Change without Purchase (See “Set Change Without Purchase” on page 141.) is set less than \$1.00 and the bill is NOT stacked - the \$1.00 bill will be returned.
 - If Change without Purchase (See “Set Change Without Purchase” on page 141.) is set to \$1.00 or more - you will receive four quarters in change.
3. Make a selection. The correct selection should be vended and correct change should be returned.

NOW WHAT?

There are many things you can do with your merchandiser to make it more flexible. Refer to the following Programming Section beginning with “Programming: Introduction” on page 42 for this and other procedures.

Programming: Introduction

The Display

The Merchant™ features our new interactive menu display. The LCD display makes navigating the programming menu structure easy and intuitive.

- The top line of the screen is the menu title.
- Selected items are highlighted in white.

•Press  or  to highlight an item.

•Press  to select it. In the example at

right, pressing  will display the **Screen Contrast** menu.

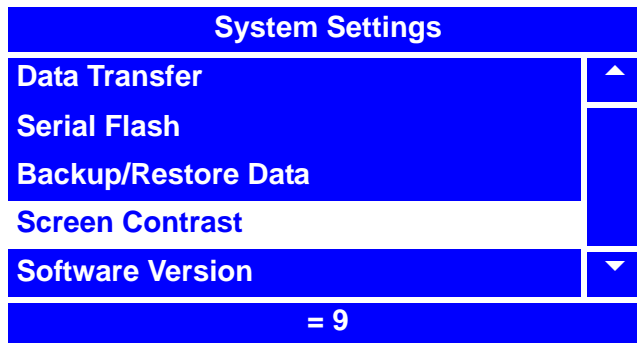

- Pay attention to the bottom line of the display as it often shows important information. In certain configuration menus, it will display the current value for the selected item. In the example above, we can see that the setting for **Screen Contrast** is reading “= 9”. This is a valuable way to quickly check the settings of the merchandiser, and to confirm that a value you changed is correct.

- To return to the Idle mode from any screen, simply press  until the display shows an idle message.

The Keypads

This merchandiser has two keypads:

- Service Keypad** This 16 button keypad is located on the upper left hand side of the monetary assembly and is only available with the merchandiser’s door open. This is the principal keypad operators use to program the merchandiser.
- Customer Keypad** This is the 13 button keypad on the front of the merchandiser. Customers use it to make selections, and operators can use it to enter numbers when programming the merchandiser.

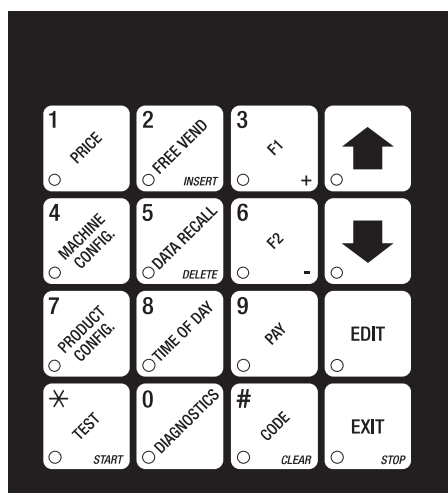

SERVICE KEYPAD

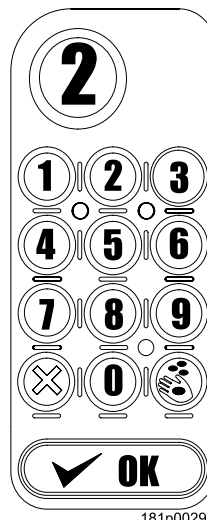

CUSTOMER KEYPAD

Service Keypad Shortcut Keys

From the idle mode, these service keys will take you directly to specific programs without having to go through the Main Menu.



Press this button to put your machine into the Price Setting menu. You can see maximum and minimum machine prices, and change prices for entire machine, entire tray, or individual selections.



Press this button to select the Free Vend modes.



Press this button to view the temperature of a cold unit, or software version numbers.



Press this button to enter the System Settings menu to:

- Select display language.
- Select coin mechanism bill validator, card reader, and options.
- Set Display Options.
- Set Data Transfer Options.
- Set Temperature and more.



Press this button to view total sales and vends by whole machine or selection. Clear resettable data.



Press this button to enter the Data Transfer menu (found in System Settings menu):



Press this button to enter the Product Configuration menu to:

- Set machine configuration
- Set which selections are active
- Set FIFO
- Couple/uncouple tray motors
- Set up SureVend™ options



Press this button to set time of day and date.



Press this button to fill the coin mech to pay one or more coins from the coin mechanism and to see the tube status.



- Allows you to see any fault in the machine.



Press this button to:

- Perform test vends
- Test various machine functions
- Test displays



Press this button to enter the Supervisor mode.

Other Keys

The MOVEMENT keys on the service keypad move you around a menu, and back and forth between menus. Along with the number keys on the Customer Keypad, every function for the Merchant™ can be programmed with these keys.



Use the up and down arrow keys to scroll through any menu list and highlight the desired option. An option is not selected until it is highlighted and  is pressed.





This key performs these functions: First, from the idle mode, it enters the Main Menu. Second, in a menu screen, it selects the highlighted option and moves to that screen. Third, in a screen that requires a value to be entered, it “locks in” the entered value and moves up to the parent menu.







This is your "end" key. Pressing it one or more times will move you up the menu hierarchy, ending back at the idle mode.

Important Note:



When in a screen that requires a selection, use  rather than  to lock in the entered value and move up to the previous menu.  will move to the previous menu *without* locking in the entered value, except on those menu screens using the “X” boxes.

Programming: Data Recall

View Non Resettable Sales and Vend Data

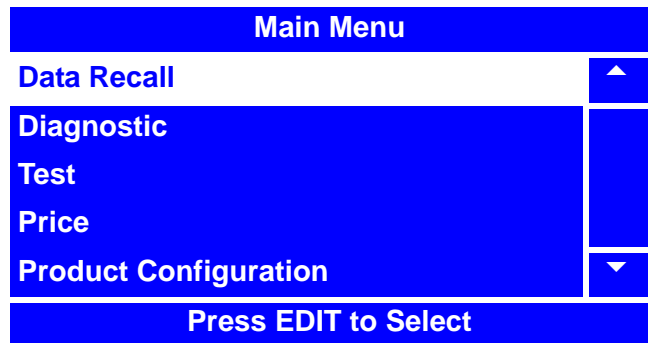
1. Press  until you reach the **Main Menu**, then use  or  to select **Data Recall** and press .



2. In the **Data Recall** menu, use  or  to select **Non Resettable Sales Data** and press .

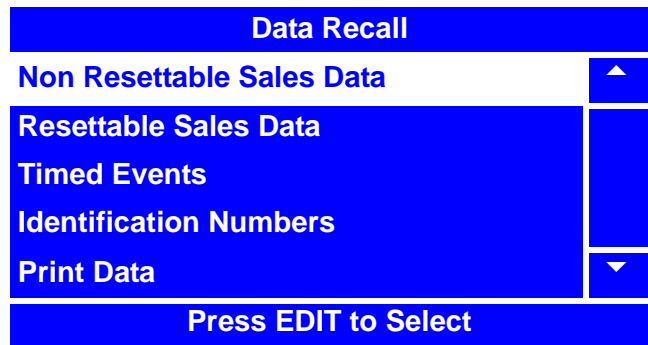

3. To view **Overall Totals** for the merchant, select **Overall Totals** and press .

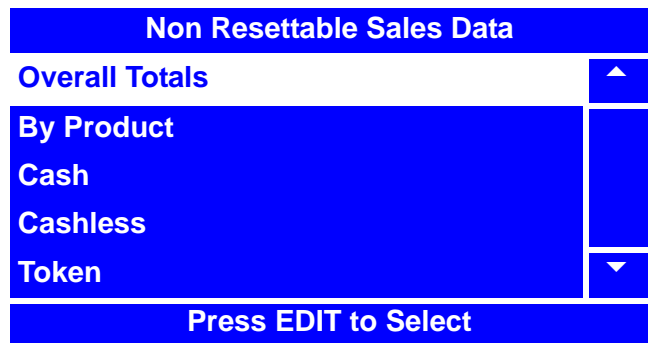

View Non Resettable Sales and Vend Data (continued)

4. The **Overall Totals** menu displays both the total dollar amount and total vend amounts for the following data:



- Sales
- Discount
- Test Vend
- Surcharge
- Free Vend

Overall Totals		
Sales-\$	688.75	▲
Sales-#	551	
Discounts-\$	0.50	
Discounts-#	5	
Test Vend-\$	8.75	
Test Vend-#	7	▼

5. For example,

- Sales-\$** Displays the total merchandiser sales in dollars.
- Sales-#** Displays the total number of merchandiser vends (Sales totals includes Discount and Surcharge totals.)
- Discount-\$** Displays the total dollar value of all discounts in dollars (ex. 5 discount vends of 10% on \$1.00 selection will total \$.50.)
- Discount-#** Displays the total number of discounted vends.
- Test Vend-\$** Displays the total dollar value of all test vends.
- Test Vend-#** Displays the total number of test vends.
- *Surcharge-\$** Displays the total dollar value of all surcharges.
- *Surcharge-#** Displays the total number of surcharge vends.
- Free Vend-\$** Displays the total dollar value of free vends.
- Free Vend-#** Displays the total number of free vends.





* - Surcharge refers to the amount of money charged above the cost to accommodate a coin mech and bill validator function when separate prices are set for card reader.

6. Press  and  to scroll through the entire list.



7. Press  once to return to the **Non Resettable Sales Data** menu or continue to press

 to return to the **Main Menu**.

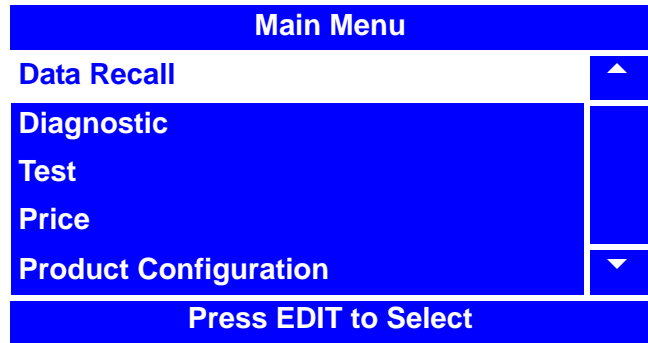

View Non Resettable Sales and Vend Data By Product

1. Press  until you reach the **Main Menu**, then use  or  to select **Data Recall** and press .

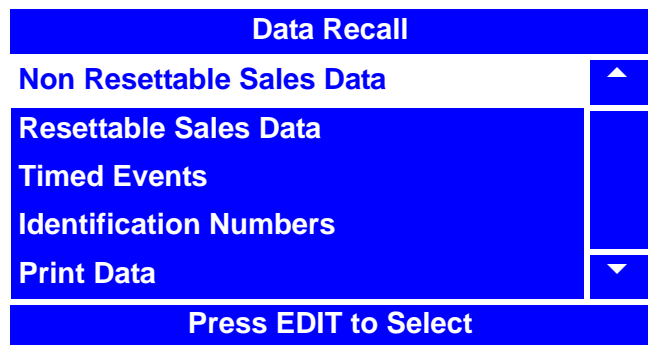

2. In the **Data Recall** menu, use  or  to select **Non Resettable Sales Data** and press .



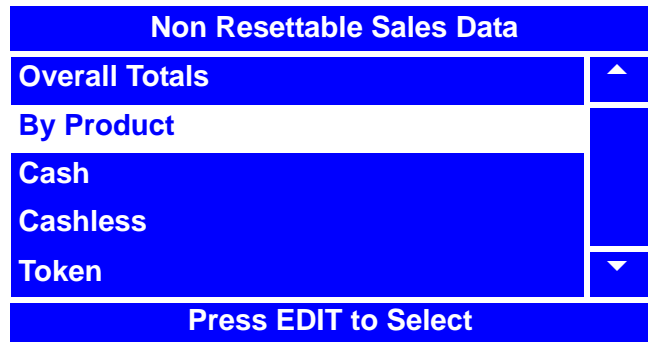

3. In the **Non Resettable Sales Data** menu, use  or  to select **By Product** and press .



NOTE

The **By Product** menu lists all currently programmed selections.

4. Press  or  to scroll through the entire list.



5. Highlight a selection and press  to view its sales totals.

View Non Resettable Sales and Vend Data By Product (continued)

6. The Product Total (“XXX”) menu screen displays the price of the selection, and both the total dollar amount and total vend amount for the following data:

- Sales
- Discount
- Surcharge
- Test Vend
- Free Vend

101	
Price-\$	1.25 ▲
Sales-\$	388.75
Sales-#	311
Discounts-\$	0.45
Discounts-#	3
Surcharge-\$	0.85 ▼

For example,





- Sales-\$** Displays the total merchandiser sales in dollars.
- Sales-#** Displays the total number of merchandiser vends (Sales totals includes Discount and Surcharge totals.)
- Discount-\$** Displays the total dollar value of all discounts in dollars (ex. 5 discount vends of 10% on \$1.00 selection will total \$.50.)
- Discount-#** Displays the total number of discounted vends.
- Test Vend-\$** Displays the total dollar value of all test vends.
- Test Vend-#** Displays the total number of test vends.
- *Surcharge-\$** Displays the total dollar value of all surcharges.
- *Surcharge-#** Displays the total number of surcharge vends.
- Free Vend-\$** Displays the total dollar value of free vends.
- Free Vend-#** Displays the total number of free vends.

* - Surcharge refers to the amount of money charged above the cost to accommodate a coin mech and bill validator function when separate prices are set for card reader.



7. Press  once to return to the **By Product** menu, twice to return to the **Resettable Sales**

Data menu, or continue to press  until you reach the **Main Menu**.



View Non Resettable Sales and Vend Data - Cash

1. Press  until you reach the **Main Menu**, then use  or  to select **Data Recall** and press .

Main Menu	
Data Recall	▲
Diagnostic	
Test	
Price	
Product Configuration	▼
Press EDIT to Select	

2. In the **Data Recall** menu, use  or  to select **Non Resettable Sales Data** and press .

Data Recall	
Non Resettable Sales Data	▲
Resettable Sales Data	
Timed Events	
Identification Numbers	
Print Data	▼
Press EDIT to Select	

3. In the **Non Resettable Sales Data** menu, use  or  to select **Cash** and press .

Non Resettable Sales Data	
Overall Totals	▲
By Product	
Cash	
Cashless	
Token	▼
Press EDIT to Select	

4. The **Cash** menu displays both the total dollar amount and total vend amounts for the following data:
- Cash In
 - To Cashbox
 - To Tubes
 - Bills In
 - Dispensed
 - Man. Dispense
 - Sales
 - Discounts
 - Surcharge
 - Overpay
 - Filled
 - Credited

Cash		
Cash In-\$	153.00	▲
To Cashbox-\$	65.00	
To Tubes-\$	88.00	
Bills In-\$	115.00	
Dispensed	93.00	
Man. Dispense	6.00	▼



View Non Resettable Sales and Vend Data - Cash (continued)

5. For example,

Cash In-\$	Displays the total cash value in (including manual feed).
To Cashbox-\$	Displays the total coin value to the cash box.
To Tubes-\$	Displays the total coin value to coin tubes (including manual feed).
Bills In-\$	Displays the total bill value in both the recycler and manual dispense.
Dispensed-\$	Displays the total cash value dispensed in both the recycler and manual dispense).
Man. Dispense-\$	Displays the total cash value dispensed manually and by the recycler.
Sales-\$	Displays the total merchandiser sales in dollars.
Sales-#	Displays the total number of merchandiser vends (Sales totals includes Discount and Surcharge totals.)
Discount-\$	Displays the total dollar value of all discounts in dollars (ex. 5 discount vends of 10% on \$1.00 selection will total \$.50.)
Discount-#	Displays the total number of discounted vends.
*Surcharge-\$	Displays the total dollar value of all surcharges.
*Surcharge-#	Displays the total number of surcharge vends.
**Overpay-\$	Displays the total cash value of overpays.
**Overpay-#	Displays the total number of overpays.
Filled-\$	Displays the total cash value of overfills.
Filled-#	Displays the total number of overfills.





* - Surcharge refers to the amount of money charged above the cost to accommodate a coin mech and bill validator function when separate prices are set for card reader.

** - Overpay allows the customer to make purchases even if there is no change. The merchandiser screen will display "USE EXACT AMOUNT".



6. Press  and  to scroll through the entire list.

7. Press  once to return to the **Non Resettable Sales Data** menu or continue to press  to return to the **Main Menu**.



View Non Resettable Sales and Vend Data - Cashless

1. Press  until you reach the **Main Menu**, then use  or  to select **Data Recall** and press .

Main Menu	
Data Recall	▲
Diagnostic	
Test	
Price	
Product Configuration	▼
Press EDIT to Select	

2. In the **Data Recall** menu, use  or  to select **Non Resettable Sales Data** and press .

Data Recall	
Non Resettable Sales Data	▲
Resettable Sales Data	
Timed Events	
Identification Numbers	
Print Data	▼
Press EDIT to Select	

3. In the **Non Resettable Sales Data** menu, use  or  to select **Cashless** and press .

Non Resettable Sales Data	
Overall Totals	▲
By Product	
Cash	
Cashless	
Token	▼
Press EDIT to Select	

4. The **Cashless** menu displays both the total dollar amount and total vend amounts for the following data:
- Sales
 - Debited
 - Credited
 - Discounts
 - Surcharge
 - Revalue

Cashless	
Sales-\$	153.00 ▲
Sales-#	65.00
Debited-\$	88.00
Debited-#	115.00
Credited-\$	93.00
Credited-#	6.00 ▼



View Non Resettable Sales and Vend Data - Cashless (continued)

5. For example,

- Sales-\$** Displays the total value of cashless sales.
- Sales-#** Displays the total number of cashless sales.
- Debited-\$** Displays the total value of debited sales.
- Debited-#** Displays the total number of debited sales.
- Credited-\$** Displays the total value of credited sales.
- Credited-#** Displays the total number of credited sales.
- Discounts-\$** Displays the total value of cashless discounts
- Discounts-#** Displays the total number of cashless discounts.
- *Surcharge-\$** Displays the total value of cashless surcharges.
- *Surcharge-#** Displays the total number of cashless surcharges.
- **Revalue-\$** Displays the total value of revalues.
- **Revalue-#** Displays the total number of revalues.





* - Surcharge refers to the amount of money charged above the cost to accommodate a coin mech and bill validator function when separate prices are set for card reader.

** - Credits cash that has been deposited into the merchandiser onto a card which is then used for that specific merchandiser. (Only certain card readers offer this option.)



6. Press  and  to scroll through the entire list.

7. Press  once to return to the **Non Resettable Sales Data** menu or continue to press  to return to the **Main Menu**.



View Non Resettable Sales and Vend Data - Token

1. Press  until you reach the **Main Menu**, then use  or  to select **Data Recall** and press .

Main Menu	
Data Recall	▲
Diagnostic	
Test	
Price	
Product Configuration	▼
Press EDIT to Select	

2. In the **Data Recall** menu, use  or  to select **Non Resettable Sales Data** and press .

Data Recall	
Non Resettable Sales Data	▲
Resettable Sales Data	
Timed Events	
Identification Numbers	
Print Data	▼
Press EDIT to Select	

3. In the **Non Resettable Sales Data** menu, use  or  to select **Token** and press .

Non Resettable Sales Data	
Overall Totals	▲
By Product	
Cash	
Cashless	
Token	▼
Press EDIT to Select	

4. The **Token** menu displays both the total dollar amount and total vend amounts for the following data:
- Vend Token
 - Value Token
 - Overpay

Token		
Vend Token-\$	153.00	▲
Vend Token-#	65.00	
Value Token-\$	88.00	
Value Token-#	115.00	
Overpay-\$	93.00	
Overpay-#	6.00	▼



View Non Resettable Sales and Vend Data - Token (continued)

5. For example,

- Vend Token-\$** Displays the total values of token vends.
- Vend Token-#** Displays the total number of token vends.
- Value Token-\$** *(see below)
- Value Token-#** *(see below)
- Overpay-\$** *(see below)
- Overpay-#** *(see below)





NOTE

The above functions marked with a * are not currently available, even though they may appear on the menu screen. These functions will be supported in a future release of merchandiser software.



6. Press  and  to scroll through the entire list.

7. Press  once to return to the **Non Resettable Sales Data** menu or continue to press  to return to the **Main Menu**.

View Resettable Sales and Vend Data

- Press  until you reach the **Main Menu**, then use  or  to select **Data Recall** and press .

Main Menu	
Data Recall	▲
Diagnostic	
Test	
Price	
Product Configuration	▼
Press EDIT to Select	

- In the **Data Recall** menu, use  or  to select **Resettable Sales Data** and press .

Data Recall	
Non Resettable Sales Data	▲
Resettable Sales Data	
Timed Events	
Identification Numbers	
Print Data	▼
Press EDIT to Select	

- To view Resettable Sales Data **Overall Totals** for the merchandiser, select **Overall Totals** and press .

Resettable Sales Data	
Overall Totals	▲
By Product	
Cash	
Cashless	
Token	▼
Press EDIT to Select	

View Resettable Sales and Vend Data (continued)

4. The **Overall Totals** menu displays both the total dollar amount and total vend amount for the following data:



- Sales
- Discount
- Test Vend
- Surcharge
- Free Vend

Overall Totals		
Sales-\$	688.75	▲
Sales-#	551	
Discounts-\$	0.50	
Discounts-#	5	
Test Vend-\$	8.75	
Test Vend-#	7	▼

5. For example,





- Sales-\$** Displays the total merchandiser sales in dollars.
- Sales-#** Displays the total number of merchandiser vends (Sales totals includes Discount and Surcharge totals.)
- Discount-\$** Displays the total dollar value of all discounts in dollars (ex. 5 discount vends of 10% on \$1.00 selection will total \$.50.)
- Discount-#** Displays the total number of discounted vends.
- Test Vend-\$** Displays the total dollar value of all test vends.
- Test Vend-#** Displays the total number of test vends.
- *Surcharge-\$** Displays the total dollar value of all surcharges.
- *Surcharge-#** Displays the total number of surcharge vends.
- Free Vend-\$** Displays the total dollar value of free vends.
- Free Vend-#** Displays the total number of free vends.

* - Surcharge refers to the amount of money charged above the cost to accommodate a coin mech and bill validator function when separate prices are set for card reader.



6. Press  and  to scroll through the entire list.

7. Press  once to return to the **Resettable Sales Data** menu or continue to press  to return to the **Main Menu**.

View Resettable Sales and Vend Data By Product

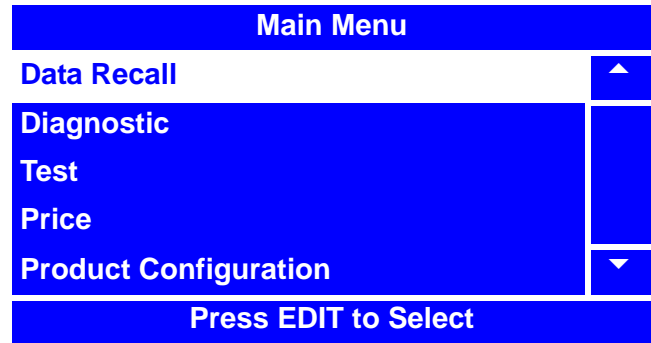
1. Press  until you reach the **Main Menu**, then use  or  to select **Data Recall** and press .



2. In the **Data Recall** menu, use  or  to select **Resettable Sales Data** and press .

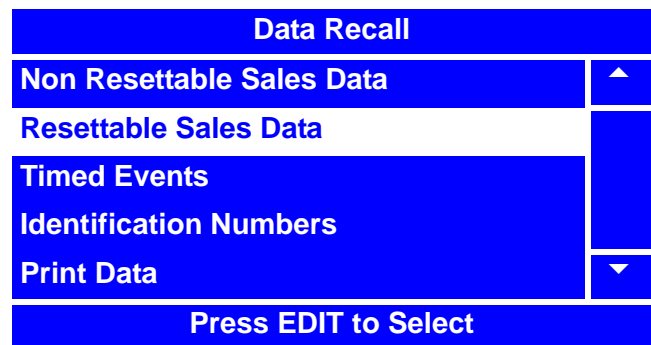

3. In the **Resettable Sales Data** menu, use  or  to select **By Product** and press .

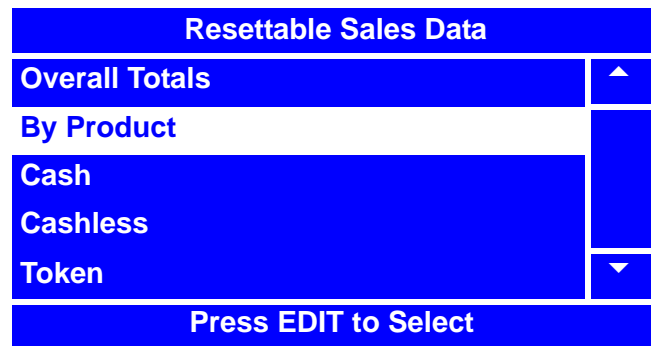

NOTE

The **By Product** menu lists all currently programmed selections.

4. Press  or  to scroll through the entire list.



5. Highlight a selection and press  to view its sales totals.

View Resettable Sales and Vend Data By Product (continued)

6. The Product Total (“XXX”) menu screen displays the price of the selection, and both the total dollar amount and total vend amount for the following data:

- Sales
- Discount
- Surcharge
- Test Vend
- Free Vend

101	
Price-\$	1.25 ▲
Sales-\$	388.75
Sales-#	311
Discounts-\$	0.45
Discounts-#	3
Surcharge-\$	0.85 ▼

For example,





- Sales-\$** Displays the total merchandiser sales in dollars.
- Sales-#** Displays the total number of merchandiser vends (Sales totals includes Discount and Surcharge totals.)
- Discount-\$** Displays the total dollar value of all discounts in dollars (ex. 5 discount vends of 10% on \$1.00 selection will total \$.50.)
- Discount-#** Displays the total number of discounted vends.
- Test Vend-\$** Displays the total dollar value of all test vends.
- Test Vend-#** Displays the total number of test vends.
- *Surcharge-\$** Displays the total dollar value of all surcharges.
- *Surcharge-#** Displays the total number of surcharge vends.
- Free Vend-\$** Displays the total dollar value of free vends.
- Free Vend-#** Displays the total number of free vends.

* - Surcharge refers to the amount of money charged above the cost to accommodate a coin mech and bill validator function when separate prices are set for card reader.



7. Press  once to return to the **By Product** menu, twice to return to the **Resettable Sales**

Data menu, or continue to press  until you reach the **Main Menu**.



View Resettable Sales and Vend Data - Cash

1. Press  until you reach the **Main Menu**, then use  or  to select **Data Recall** and press .

Main Menu	
Data Recall	▲
Diagnostic	
Test	
Price	
Product Configuration	▼
Press EDIT to Select	

2. In the **Data Recall** menu, use  or  to select **Resettable Sales Data** and press .

Data Recall	
Non Resettable Sales Data	▲
Resettable Sales Data	
Timed Events	
Identification Numbers	
Print Data	▼
Press EDIT to Select	

3. In the **Non Resettable Sales Data** menu, use  or  to select **Cash** and press .

Resettable Sales Data	
Overall Totals	▲
By Product	
Cash	
Cashless	
Token	▼
Press EDIT to Select	

4. The **Cash** menu displays both the total dollar amount and total vend amounts for the following data:
- Cash In
 - To Cashbox
 - To Tubes
 - Bills In
 - Dispensed
 - Man. Dispense
 - Sales
 - Discounts
 - Surcharge
 - Overpay
 - Filled
 - Credited

Cash		
Cash In-\$	153.00	▲
To Cashbox-\$	65.00	
To Tubes-\$	88.00	
Bills In-\$	115.00	
Dispensed	93.00	
Man. Dispense	6.00	▼



View Resettable Sales and Vend Data - Cash (continued)

5. For example,

Cash In-\$	Displays the total cash value in (including manual feed).
To Cashbox-\$	Displays the total coin value to the cash box.
To Tubes-\$	Displays the total coin value to coin tubes (including manual feed).
Bills In-\$	Displays the total bill value in both the recycler and manual dispense.
Dispensed-\$	Displays the total cash value dispensed in both the recycler and manual dispense).
Man. Dispense-\$	Displays the total cash value dispensed manually and by the recycler.
Sales-\$	Displays the total merchandiser sales in dollars.
Sales-#	Displays the total number of merchandiser vends (Sales totals includes Discount and Surcharge totals.)
Discount-\$	Displays the total dollar value of all discounts in dollars (ex. 5 discount vends of 10% on \$1.00 selection will total \$.50.)
Discount-#	Displays the total number of discounted vends.
*Surcharge-\$	Displays the total dollar value of all surcharges.
*Surcharge-#	Displays the total number of surcharge vends.
Overpay-\$	Displays the total cash value of overpays.
Overpay-#	Displays the total number of overpays.
Filled-\$	Displays the total cash value of overfills.
Filled-#	Displays the total number of overfills.





* - Surcharge refers to the amount of money charged above the cost to accommodate a coin mech and bill validator function when separate prices are set for card reader.

** - Overpay allows the customer to make purchases even if there is no change. The merchandiser screen will display "USE EXACT AMOUNT".



6. Press  and  to scroll through the entire list.

7. Press  once to return to the **Resettable Sales Data** menu or continue to press  to return to the **Main Menu**.



View Resettable Sales and Vend Data - Cashless

1. Press  until you reach the **Main Menu**, then use  or  to select **Data Recall** and press .

Main Menu	
Data Recall	▲
Diagnostic Test	
Price	
Product Configuration	▼
Press EDIT to Select	

2. In the **Data Recall** menu, use  or  to select **Resettable Sales Data** and press .

Data Recall	
Non Resettable Sales Data	▲
Resettable Sales Data	
Timed Events	
Identification Numbers	
Print Data	▼
Press EDIT to Select	

3. In the **Resettable Sales Data** menu, use  or  to select **Cashless** and press .

Resettable Sales Data	
Overall Totals	▲
By Product	
Cash	
Cashless	
Token	▼
Press EDIT to Select	

4. The **Cashless** menu displays both the total dollar amount and total vend amounts for the following data:

- Sales
- Debited
- Credited
- Discounts
- Surcharge
- Revalue

Cashless		
Sales-\$	153.00	▲
Sales-#	65.00	
Debited-\$	88.00	
Debited-#	115.00	
Credited-\$	93.00	
Credited-#	6.00	▼



View Resettable Sales and Vend Data - Cashless (continued)

5. For example,

- Sales-\$** Displays the total value of cashless sales.
- Sales-#** Displays the total number of cashless sales.
- Debited-\$** Displays the total value of debited sales.
- Debited-#** Displays the total number of debited sales.
- Credited-\$** Displays the total value of credited sales.
- Credited-#** Displays the total number of credited sales.
- Discounts-\$** Displays the total value of cashless discounts
- Discounts-#** Displays the total number of cashless discounts.
- *Surcharge-\$** Displays the total value of cashless surcharges.
- *Surcharge-#** Displays the total number of cashless surcharges.
- **Revalue-\$** Displays the total value of revalues.
- **Revalue-#** Displays the total number of revalues.





* - Surcharge refers to the amount of money charged above the cost to accommodate a coin mech and bill validator function when separate prices are set for card reader.

** - Credits cash that has been deposited into the merchandiser onto a card which is then used for that specific merchandiser. (Only certain card readers offer this option.)



6. Press  and  to scroll through the entire list.

7. Press  once to return to the **Non Resettable Sales Data** menu or continue to press  to return to the **Main Menu**.



View Resettable Sales and Vend Data - Token

1. Press  until you reach the **Main Menu**,
 then use  or  to select **Data Recall** and press .

Main Menu	
Data Recall	▲
Diagnostic	
Test	
Price	
Product Configuration	▼
Press EDIT to Select	

2. In the **Data Recall** menu,
 use  or  to select **Resettable Sales Data** and press .

Data Recall	
Non Resettable Sales Data	▲
Resettable Sales Data	
Timed Events	
Identification Numbers	
Print Data	▼
Press EDIT to Select	

3. In the **Non Resettable Sales Data** menu,
 use  or  to select **Token**
 and press .

Resettable Sales Data	
Overall Totals	▲
By Product	
Cash	
Cashless	
Token	▼
Press EDIT to Select	

4. The **Token** menu displays both the total dollar amount and total vend amounts for the following data:

- Vend Token
- Value Token
- Overpay

Token		
Vend Token-\$	153.00	▲
Vend Token-#	65.00	
Value Token-\$	88.00	
Value Token-#	115.00	
Overpay-\$	93.00	
Overpay-#	6.00	▼

View Resettable Sales and Vend Data - Token (continued)

5. For example,

Vend Token-\$ Displays the total values of token vends.



Vend Token-# Displays the total number of token vends.

Value Token-\$ *(see below)

Value Token-# *(see below)

Overpay-\$ *(see below)

Overpay-# *(see below)





6. Press  and  to scroll through the entire list.



7. Press  once to return to the **Resettable Sales Data** menu or continue to press  to return to the **Main Menu**.

NOTE

The above functions marked with a * are not currently available, even though they may appear on the menu screen. These functions will be supported in a future release of merchandiser software.

Clear Resettable Sales and Vend Data

1. Press  until you reach the **Main Menu**, then use  or  to select **Data Recall** and press .

2. In the **Data Recall** menu, use  or  to select **Resettable Sales Data** and press .

NOTE

To access the **Clear Data** menu screen, you must first have entered the Supervisor's PIN code. For instructions on entering this code, refer to "Enter Security Code" on page 193.

3. In the **Resettable Data** screen, select **Clear Data** and press .

4. The **Clear Data** screen confirms that you want to clear resettable data.



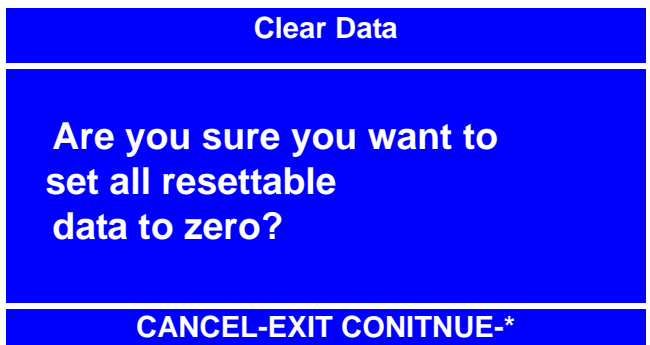
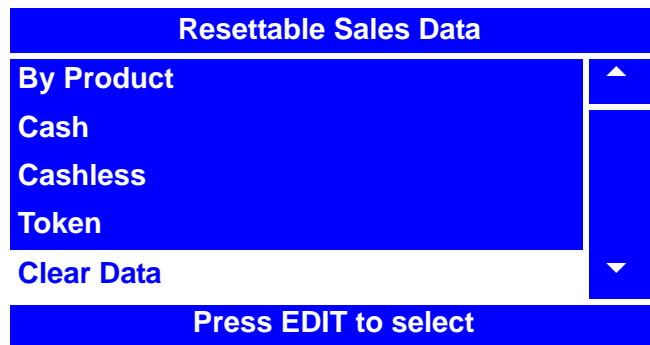
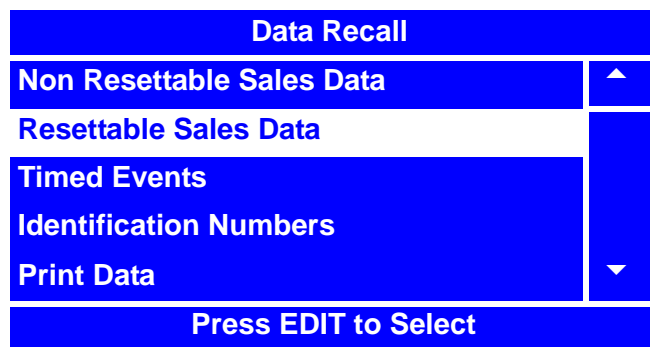
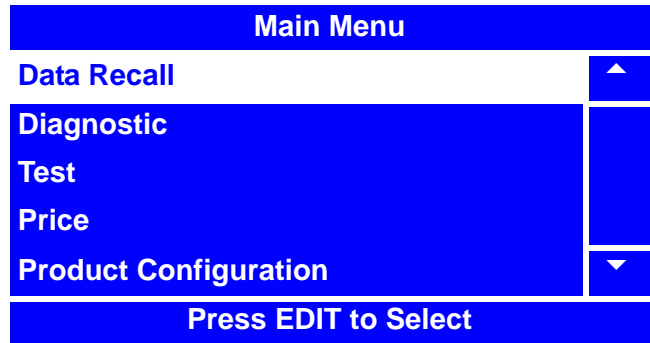

a. Press  to clear the data.

b. Press  to exit without clearing the data.



5. After clearing data, you will automatically return to the **Resettable Sales Data** menu screen. Press  once to return to the **Data Recall** menu screen or twice to return to the **Main Menu**.





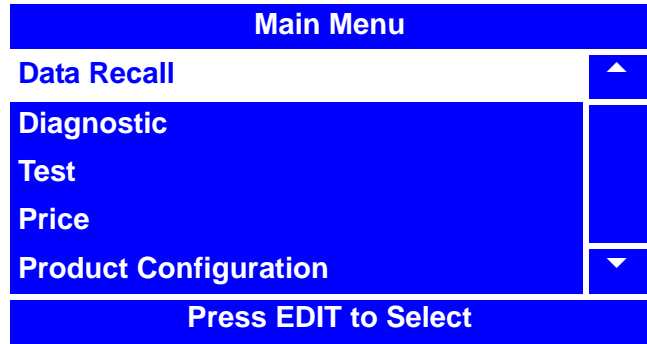

View Timed Events - Main Door Openings

1. Press  until you reach the **Main Menu**, then use  or  to select **Data Recall**, and press .

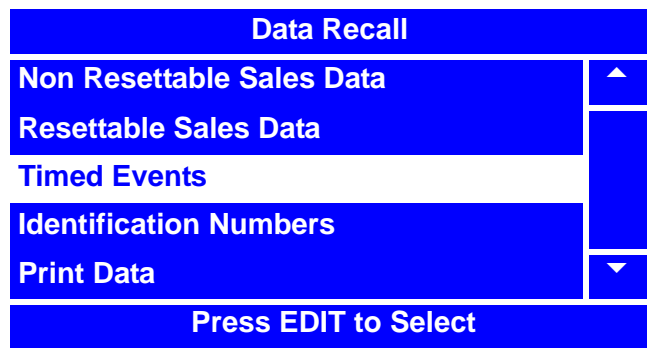

2. In the **Data Recall** menu, use  or  to select **Timed Events** and press .



3. In the **Timed Events** menu, use  or  to select **Main Door Openings** and press .

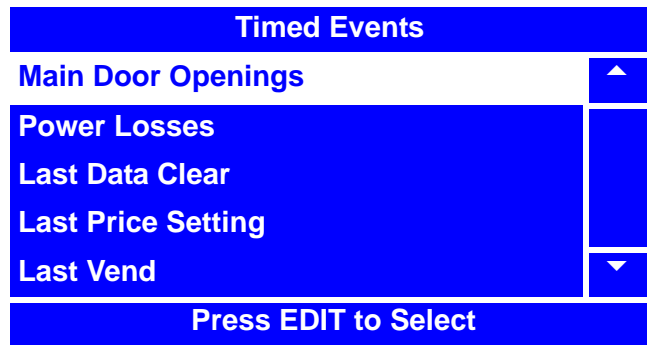

4. The **Main Door Openings** screen displays a list of dates, times and durations of main door openings.





5. Press  once to return to the **Timed Events** menu, twice to return to the **Data Recall** menu, or three times to return to the **Main Menu**.







NOTE

Each option in the **Timed Events** menu has a maximum of 16 events that can be viewed and/or set.

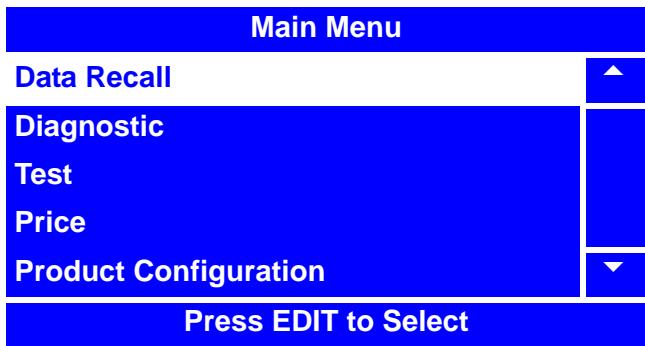

View Timed Events - Power Losses

1. Press  until you reach the **Main Menu**, then use  or  to select **Data Recall**, and press .

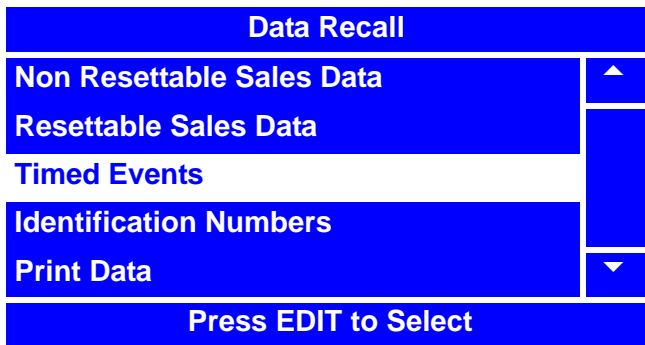

2. In the **Data Recall** menu, use  or  to select **Timed Events** and press .



3. In the **Timed Events** menu, use  or  to select **Power Losses** and press .

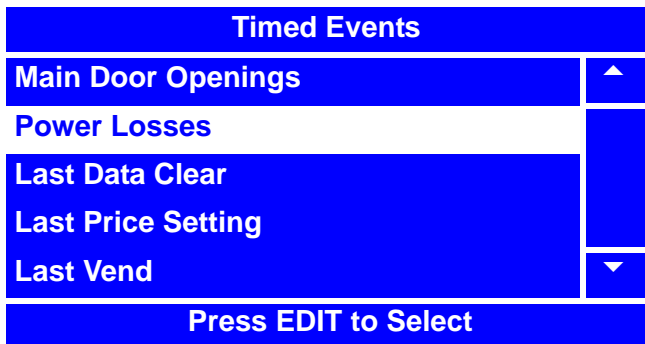

4. The **Power Losses** screen displays a list of dates, times and durations of power losses.



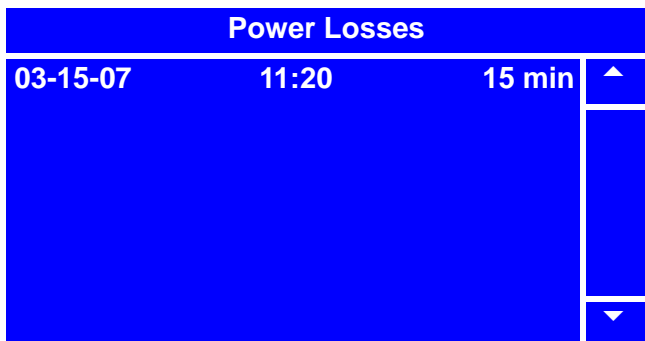

5. Press  once to return to the **Timed Events** menu, twice to return to the **Data Recall** menu, or three times to return to the **Main Menu**.







NOTE

Each option in the **Timed Events** menu has a maximum of 16 events that can be viewed and/or set.

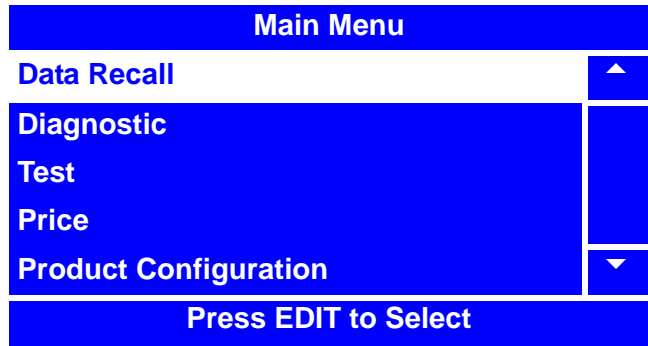

View Timed Events - Last Data Clear

1. Press  until you reach the **Main Menu**, then use  or  to select **Data Recall** and press .

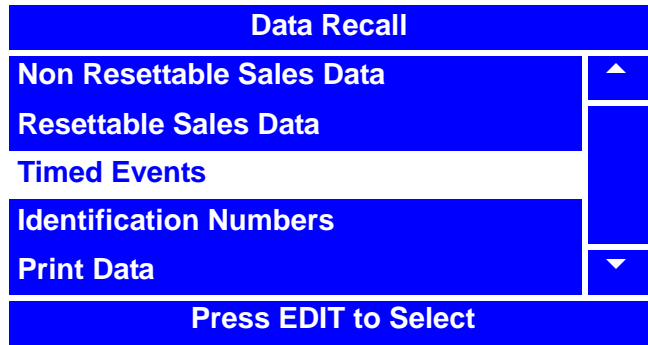

2. In the **Data Recall** menu, use  or  to select **Timed Events** and press .



3. In the **Timed Events** menu, use  or  to select **Last Data Clear** and press .

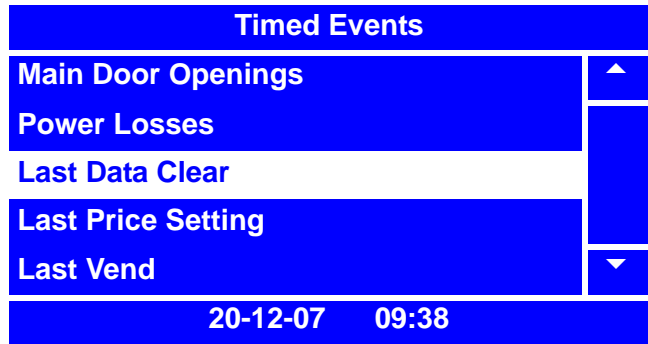

4. The **Last Data Clear** screen displays the date and time of the last data clear.



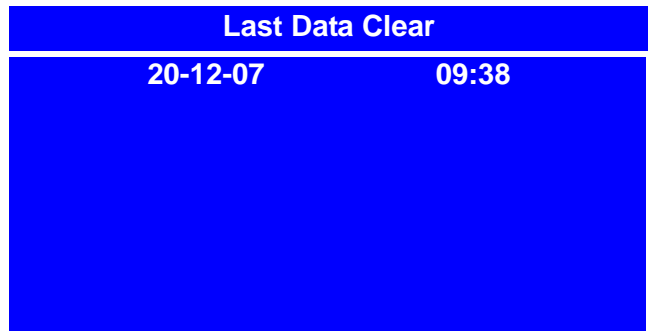

5. Press  once to return to the **Timed Events** menu, twice to return to the **Data Recall** menu, or three times to return to the **Main Menu**.







NOTE

Each option in the **Timed Events** menu has a maximum of 16 events that can be viewed and/or set.

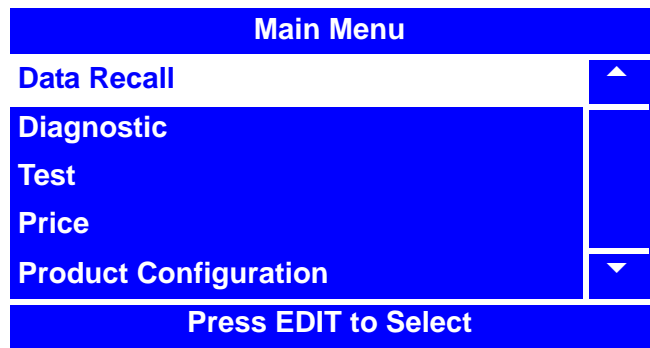

View Timed Events - Last Price Setting

1. Press  until you reach the **Main Menu**, then use  or  to select **Data Recall** and press .

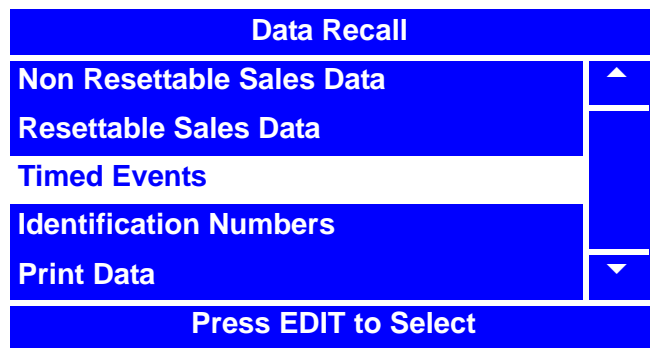

2. In the **Data Recall** menu, use  or  to select **Timed Events** and press .



3. In the **Timed Events** menu, use  or  to select **Last Price Setting** and press .

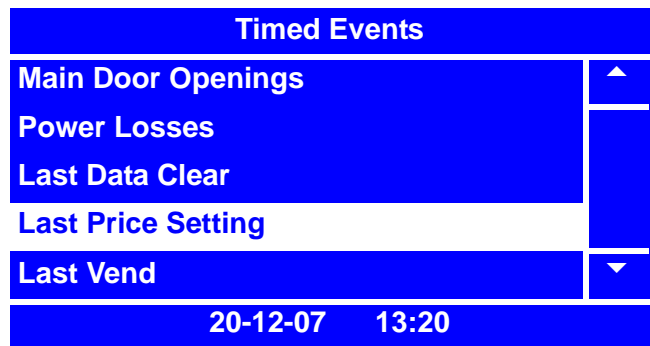

4. The **Last Price Setting** screen displays the date and time of the last price setting.





5. Press  once to return to the **Timed Events** menu, twice to return to the **Data Recall** menu, or three times to return to the **Main Menu**.







NOTE

Each option in the **Timed Events** menu has a maximum of 16 events that can be viewed and/or set.

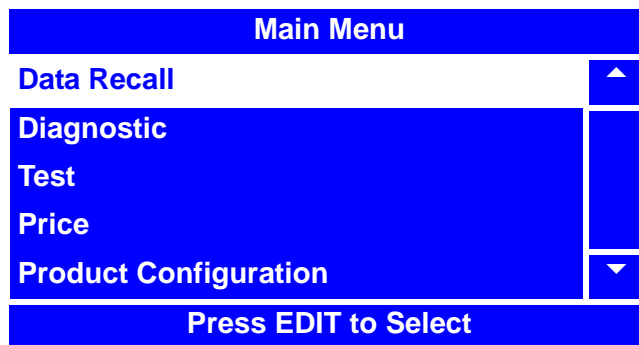

View Timed Events - Last Vend

1. Press  until you reach the **Main Menu**, then use  or  to select **Data Recall** and press .

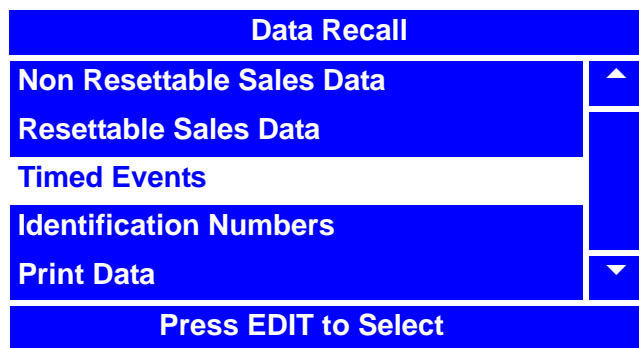

2. In the **Data Recall** menu, use  or  to select **Timed Events** and press .



3. In the **Timed Events** menu, use  or  to select **Last Vend** and press .

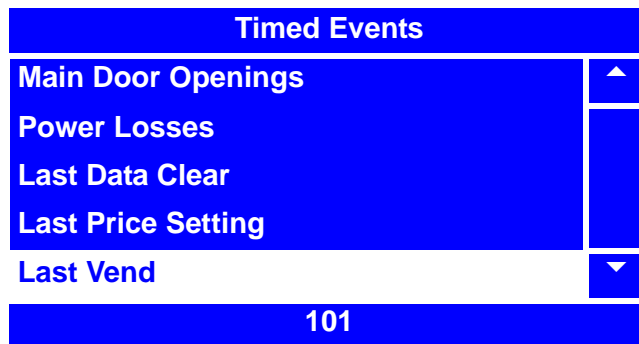

4. The **Last Vend** screen displays the date and time of the last vend.



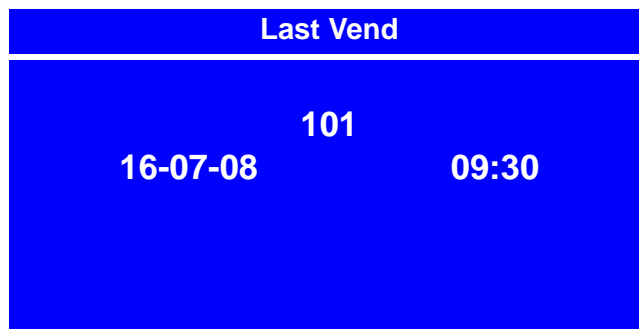

5. Press  once to return to the **Timed Events** menu, twice to return to the **Data Recall** menu, or three times to return to the **Main Menu** screen.







NOTE

Each option in the **Timed Events** menu has a maximum of 16 events that can be viewed and/or set.

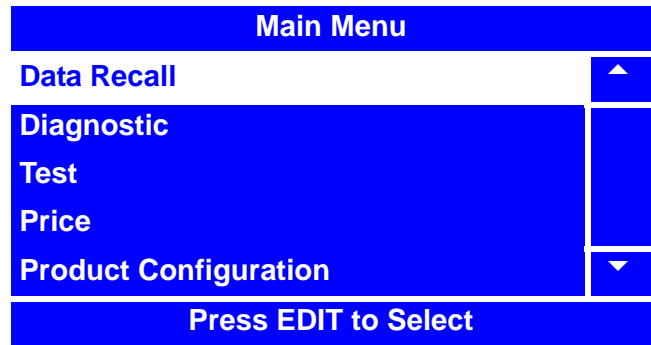

View Timed Events - Last Clock Set

1. Press  until you reach the **Main Menu**, then use  or  to select **Data Recall** and press .

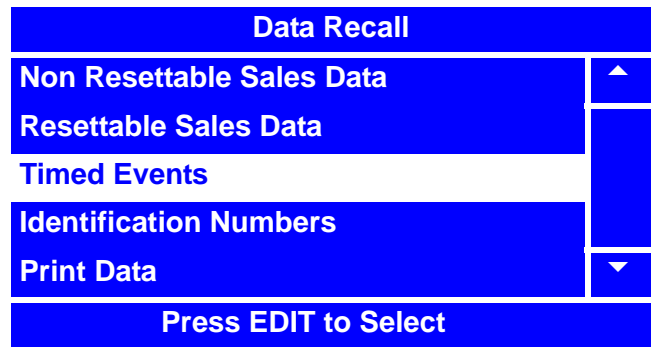

2. In the **Data Recall** menu, use  or  to select **Timed Events** and press .



3. In the **Timed Events** menu, use  or  to select **Last Clock Set** and press .

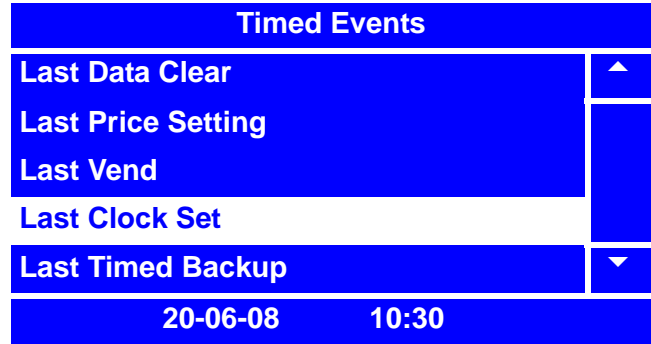

4. The **Last Clock Set** screen displays the last date and time the clock was set.



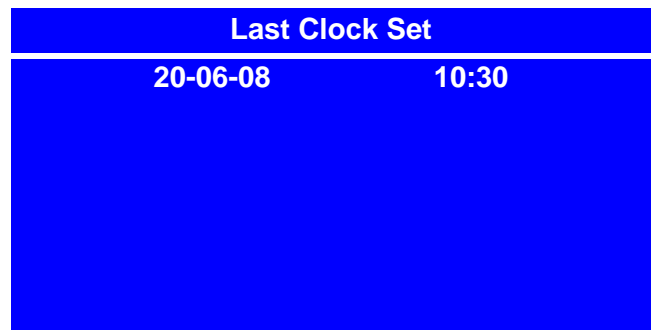

5. Press  once to return to the **Timed Events** menu, twice to return to the **Data Recall** menu, or three times to return to the **Main Menu** screen.







NOTE

Each option in the **Timed Events** menu has a maximum of 16 events that can be viewed and/or set.

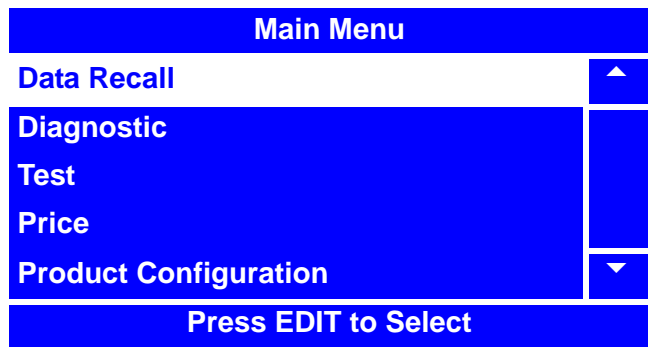

View Timed Events - Last Timed Backup

1. Press  until you reach the **Main Menu**, then use  or  to select **Data Recall** and press .

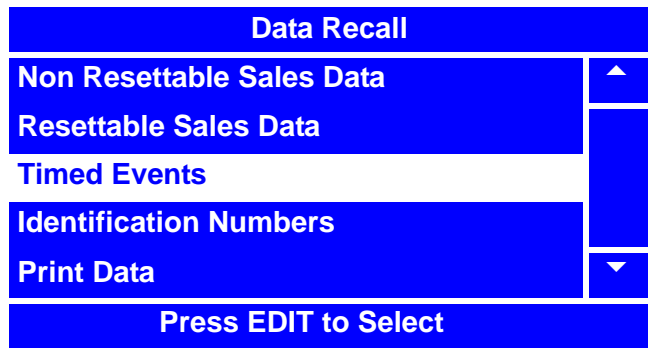

2. In the **Data Recall** menu, use  or  to select **Timed Events** and press .



3. In the **Timed Events** menu, use  or  to select **Last Timed Backup** and press .

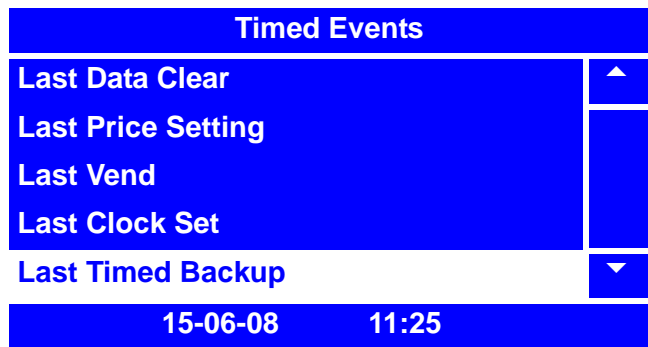

4. The **Last Timed Backup** screen displays the last date and time a timed backup was performed.



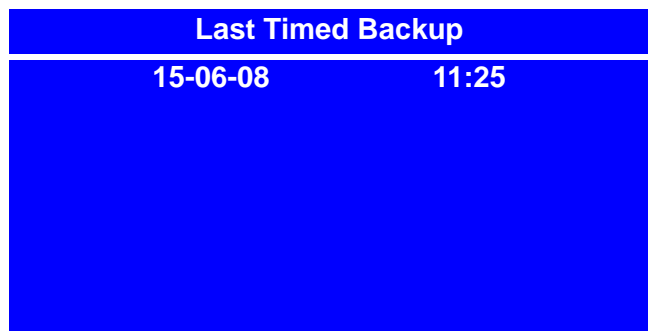

5. Press  once to return to the **Timed Events** menu, twice to return to the **Data Recall** menu, or three times to return to the **Main Menu** screen.







NOTE

Each option in the **Timed Events** menu has a maximum of 16 events that can be viewed and/or set.

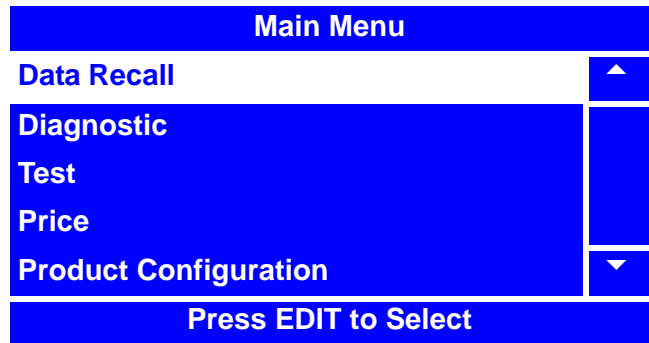

View Identification Numbers - Main PCB

1. Press  until you reach the **Main Menu**, then use  or  to select **Data Recall** and press .

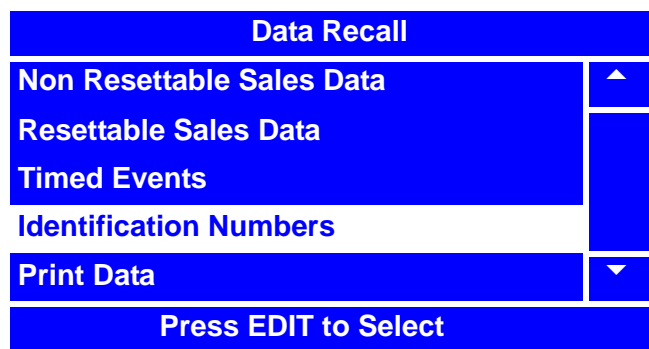

2. In the **Data Recall** menu, use  or  to select **Identification Numbers** and press .



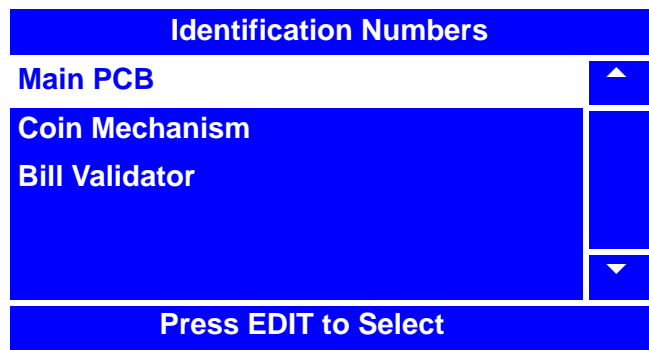

4. In the **Identification Numbers** menu, use  or  to select **Main PCB** and press .





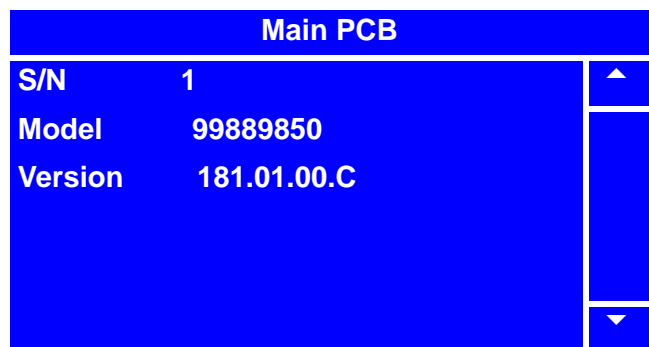

5. In the **Main PCB** menu, you can view:

- **S/N** - Serial number of board
- **Model** - Model number of board
- **Version** - Version of board software



6. Press  once to return to the **Main PCB** menu, twice to return to the **Identification Numbers** menu or continue to press  until you reach the **Main Menu**.

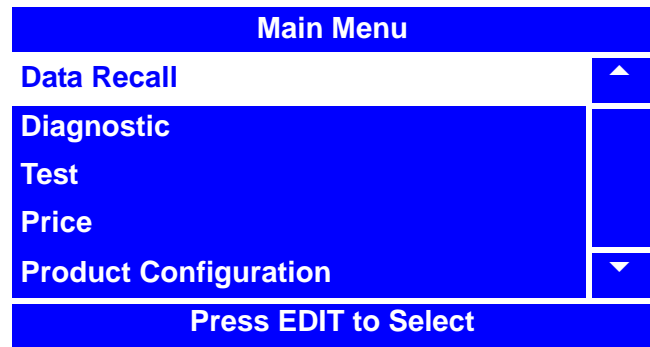

View Identification Numbers - Coin Mechanism

- Press  until you reach the **Main Menu**, then use  or  to select **Data Recall** and press .



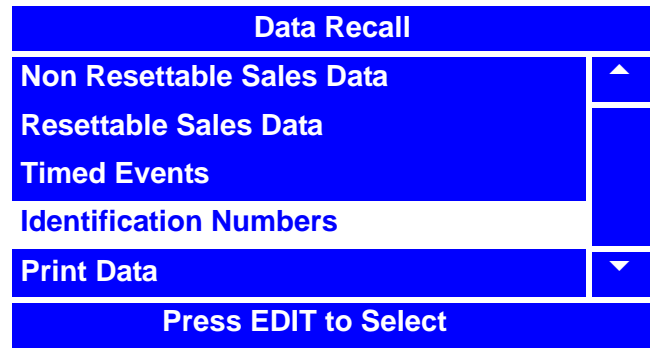

- In the **Data Recall** menu, use  or  to select **Identification Numbers** and press .



NOTE

The **Coin Mechanism** selection will only be available if an MDB level 3 or higher coin mechanism is installed in your merchandiser.

- In the **Identification Numbers** menu, use  or  to select **Coin Mechanism** and press .

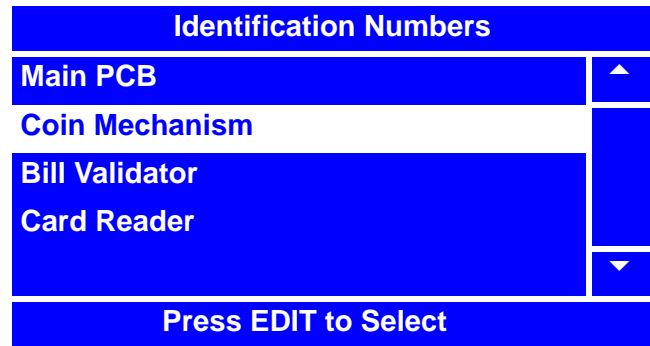



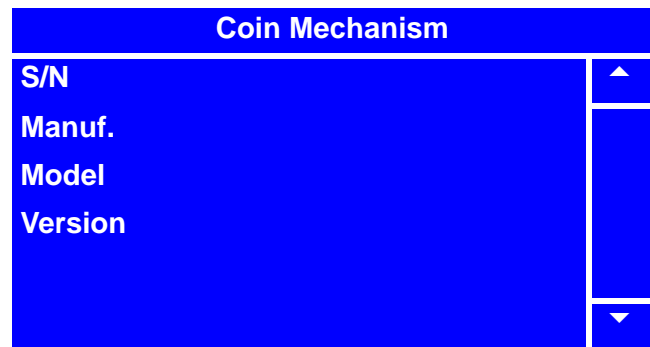



- The **Coin Mechanism** screen will display the serial number, manufacturer information, the model and the version of the installed coin mechanism.





- Press  once to return to the **Identification Numbers** menu, twice to return to the data Recall menu, or three times to return to the **Main Menu**.

View Identification Numbers - Bill Validator

1. Press  until you reach the **Main Menu**, then use  or  to select **Data Recall** and press .

2. In the **Data Recall** menu, use  or  to select **Identification Numbers** and press .



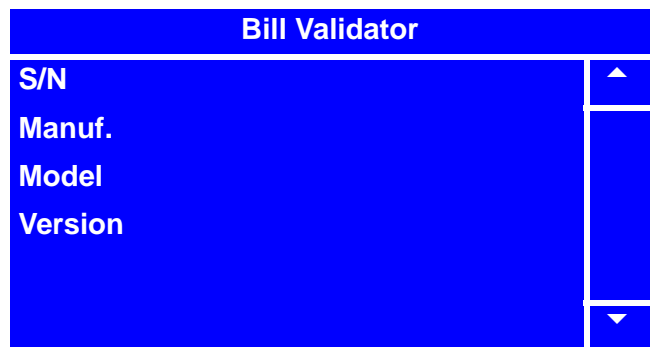
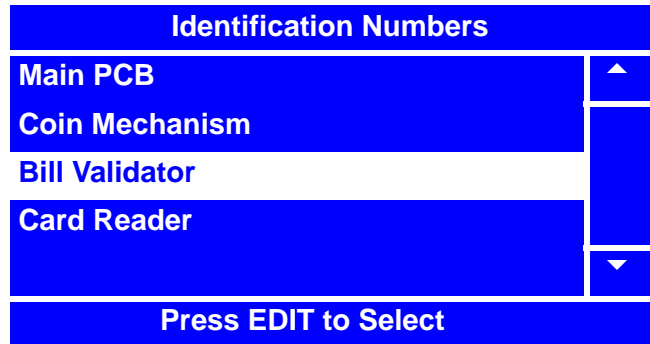
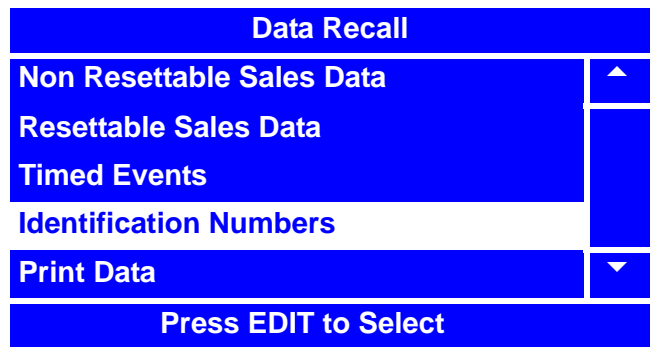
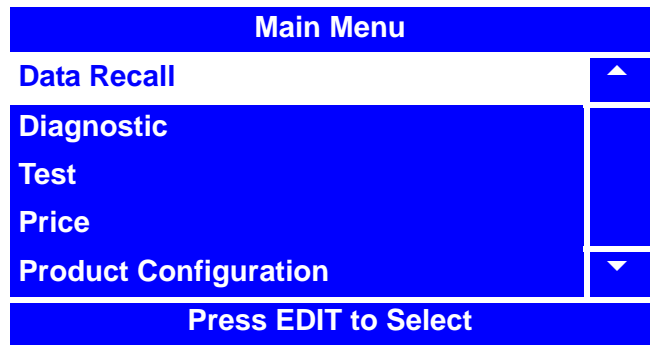

3. In the **Identification Numbers** menu, use  or  to select **Bill Validator** and press .

4. The **Bill Validator** screen will display the serial number, manufacturer information, the model and the version of the installed bill validator.



5. Press  once to return to the **Identification Numbers** menu, twice to return to the data Recall menu, or three times to return to the **Main Menu**.

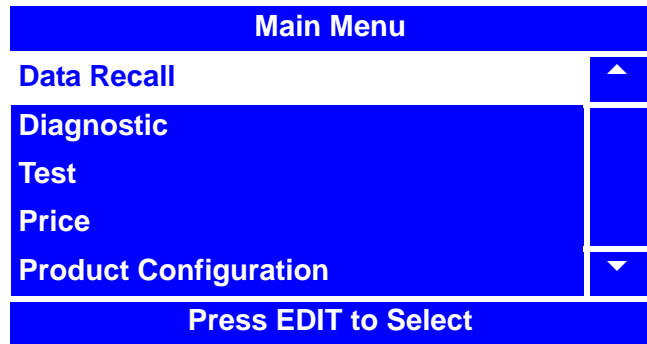

View Identification Numbers - Card Reader

1. Press  until you reach the **Main Menu**, then use  or  to select **Data Recall** and press .



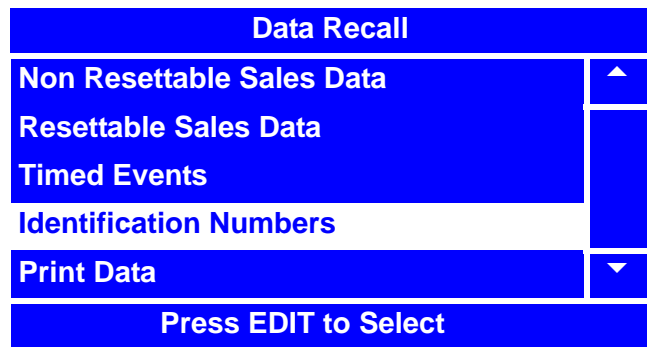

2. In the **Data Recall** menu, use  or  to select **Identification Numbers** and press .



NOTE

The **Card Reader** selection will only be available if a card reader is installed in your merchandiser.

3. In the **Identification Numbers** menu, use  or  to select **Card Reader** and press .

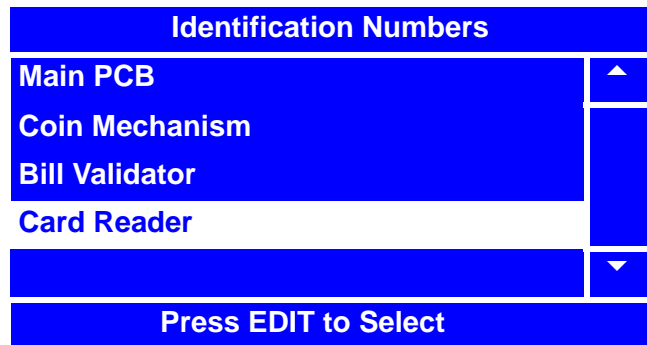





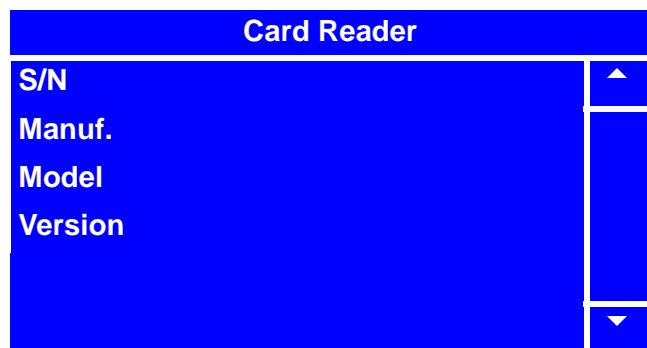

4. The **Card Reader** screen will display the serial number, manufacturer information, the model and the version of the installed card reader.

5. Press  once to return to the **Identification Numbers** menu, twice to return to the data Recall menu, or three times to return to the **Main Menu**.



Print Data

1. Press  until you reach the **Main Menu**, then use  or  to select **Data Recall** and press .

2. In the **Data Recall** menu, use  or  to select **Print Data** and press .

4. To print data using an external printer, press;
 - 1 to print **All Data**
 - 2 to print **Overall Totals**
 - 3 to print **By Product**
 - 4 to print **Cash**

5. Press  once to return to the **Data Recall** menu or twice to return to the **Main Menu** screen.





Main Menu	
Data Recall	▲
Diagnostic	
Test	
Price	
Product Configuration	▼
Press EDIT to Select	

Data Recall	
Non Resettable Sales Data	▲
Resettable Sales Data	
Timed Events	
Identification Numbers	
Print Data	▼
Press EDIT to Select	

Print Data	
Press	Data Type
1	All Data
2	Overall Totals
3	By Product
4	Cash

Programming: Diagnostic

Check for Errors

1. Press  until you reach the **Main Menu**, then use  or  to select **Diagnostic** and press .

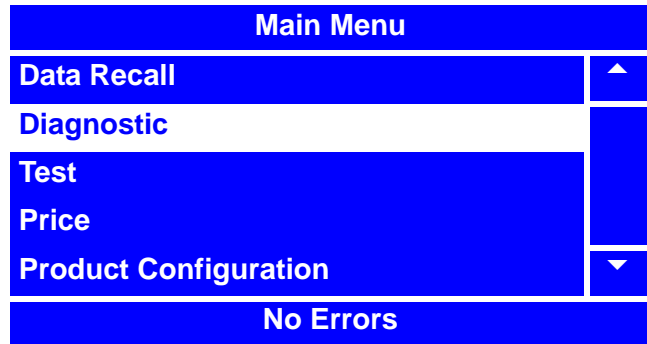

2. In the **Diagnostic** screen, if there are no errors, the screen will display **No Errors**. If an error code does display, see the table of "Diagnostic Error Messages" on page 79 to learn about the error code(s) displayed.



3. Press  once to return to the **Main Menu**.

DIAGNOSTIC ERROR MESSAGES

ERROR MESSAGE	ERROR DESCRIPTION
All Bills Disabled	The bill validator has been disabled.
All Coins Disabled	The coin mech is reporting that all the coin tubes are disabled and are out of service.
All Selections Disabled	All of the machine selections have been disabled by the user.
Bill Validator Accept Jam	A bill is jammed in the acceptance path of the bill validator.
Bill Validator Comm	Communication has been lost between the main controller and the bill validator. Check wiring harnesses and bill validator.
Bill Validator Motor	The bill validator is reporting a defective motor.
Bill Validator ROM	The bill validator is reporting a ROM checksum error.
Bill Validator Sensor	The bill validator is reporting a sensor problem.
Bill Validator Stacker is Full	The bill stacker in the bill validator is full.
Bill Validator Stacker is open	The bill validator stacker is open or removed.
Cabinet Temperature Sensor Error	An error has been reported from the cabinet temperature sensor or the sensor is not plugged in properly to the IO Board
Card Jammed in Card Reader	Card reader has failed because a card is jammed in the unit.
Card Reader Comm	Communication has been lost between the main controller and the card reader. Check wiring harnesses and card reader.
Card Reader Error	The card reader is reporting a repeating error.
Card Reader Failed OOS Err	The card reader is reporting a failure and is out of service.
Card Reader Failure	The card reader has reported a failure and is out of service.
Card Reader Reports a Comm Error & is OOS	Card reader is reporting a communication problem and is out of service.
Card Reader Reports a Comm Error	The card reader is reporting a repeating communication error but is operational.
Card Reader Requests Servicing	Card reader indicates that it requires service, reader is still operational.
Check Prices	An Invalid price has been set.
Check Winner Prize	The selection chosen for the winner prize is not valid.
Coin Mech Accept Jam	The coin mech is reporting that a coin is jammed in the acceptor section.
Coin Mech Accept Unplugged	The coin mech is reporting that the coin acceptor is unplugged from the main body of the coin mech and is out of service.

DIAGNOSTIC ERROR MESSAGES





Coin Mech All Tubes Err	The coin mech is reporting errors in all the coin tubes and is out of service.
Coin Mech Comm	Communication has been lost between the main controller and the coin mechanism. Check wiring harnesses and coin mech.
Coin Mech Payout Jam	The coin mech is reporting that a tube payout attempt has resulted in a jammed condition, it is still operational.
Coin Mech ROM	The coin mech is reporting a ROM failure and is out of service.
Coin Mech Tube Err	The coin mech is reporting a tube error, it is still operational.
Coin Mech Tube Sensor	The coin mech is reporting a tube sensor error, it is still operational.
Coin Return Motor Not Present	The coin return motor is not connected.
Coin Return Motor Run Time Timeout	The coin return motor is jammed.
Coin Return Motor Short Circuit	The coin return motor is reporting a short circuit.
Coin Return Motor Drive Failure	The coin return motor is reporting a motor error.
Condenser Coil Sensor Error	An error has been reported from the condenser coil temperature sensor or the sensor is not plugged in properly to the IO Board.
Condenser High Side Service Required: Warning	The condenser is running at too high of a temperature for an extended amount of time. Clean the condenser, check the fan motor and clean the screen.
Condenser High Side Service Required: Fatal	The condenser is running at too high of a temperature for an extended amount of time. Clean the condenser, check the fan motor and clean the screen. Refrigeration has been disabled; power cycle is required to clear.
Evaporator Coil Sensor Error	An error has been reported from the evaporator coil temperature sensor or the sensor is not plugged in properly to the IO Board.
Exec Mech Price Error	The exec coin mechanism is reporting a price error.
Factory Init Occurred	A factory initialization has occurred while the door was closed. The door must be closed while the power is on to clear this diagnostic.
Health Control Error	On a refrigerated Merchant the cabinet temperature has exceeded 41°F for an extended amount of time.
Init Failed	The snack motor interface has failed to initialize.
IO Board Voltage	The IO board voltage is out of the normal range.
Low Change	The machine is currently low on change. The low change threshold is user defined.
No Errors	Indicates there are no errors in the system.
No I/O Comm	Communication between the main controller and the IO board has been lost. Check wiring harnesses.

DIAGNOSTIC ERROR MESSAGES



No Monetary Device	There are no monetary devices present. The machine is still operational.
No Monetary Device - Fatal	There are no monetary devices present. The machine will be out of service.
Refrigeration Low Side Service Required: Warning	The IO board has reported that the machine has re-entered defrost too quickly. Cleared on a door close.
Refrigeration Low Side Service Required: Fatal	The IO board has reported that the machine has re-entered defrost too quickly. Service is required. Power cycle required to clear.
Single Card Reader Error	The card reader has reported a single error.
Snack Motor Error	The indicated selection is reporting a snack motor error. View the individual motor detail of this selection for more information.
Sold Out Selection	The indicated selection is sold out.
Stuck Key	The main controller has detected a single stuck key.
Stuck Keys - Fatal	The main controller has detected two or more stuck keys and the machine is out of service.
SureVend Anti Jackpot Error	SureVend has detected multiple sold out selections since the last door closure. The Anti-Jackpot trigger is user defined.
SureVend Calibration Error	SureVend is reporting a short circuit.
SureVend Comm Error	The IO board has lost communication with SureVend. Check wiring harnesses.
SureVend Is Blocked	SureVend is reporting a blocked sensor.

Programming: Test

Test Vend a Selection

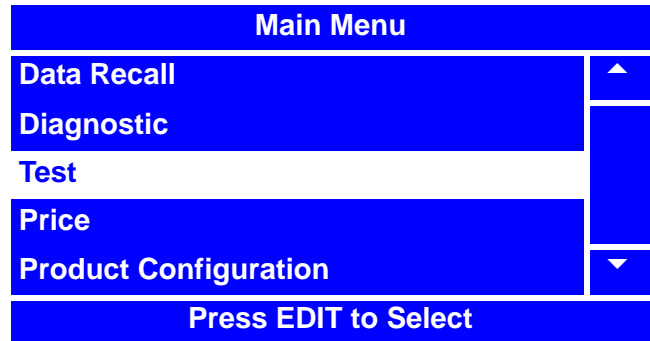
1. Press  until you reach the **Main Menu**, then use  or  to select **Test** and press .



2. In the **Test** menu, use  or  to select **Test Vend** and press .

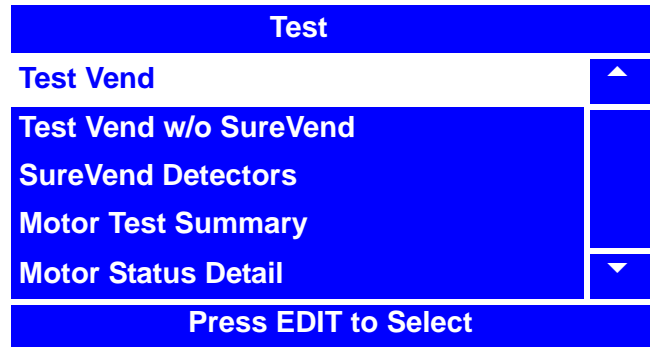

3. Make a selection (Example: **1-0-3**), then press the **OK** button.

4. The merchandiser will dispense the selection and return to the original **Test Vend** menu.

5. Test vend another selection, or press  once to return to the **Test** menu or twice to return to the **Main Menu**.

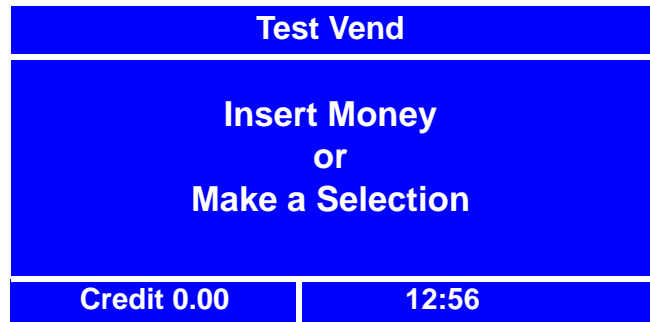





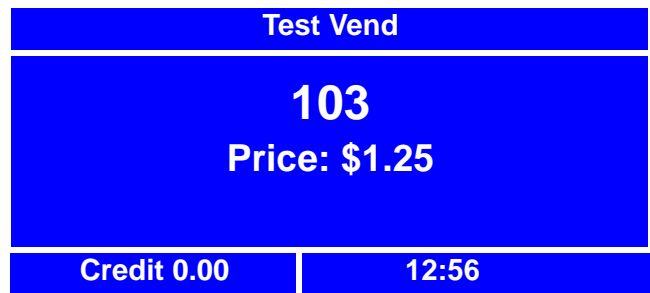



NOTE

If Merchant™ door is shut while the menu is on the **Test Vend** or the **Test Vend w/o SureVend** screens, the screen will be displayed until one **Test Vend** or **Test Vend w/o SureVend** is completed.



Test Vend Without SureVend™



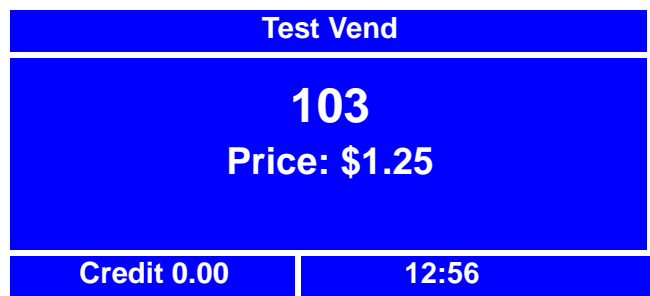
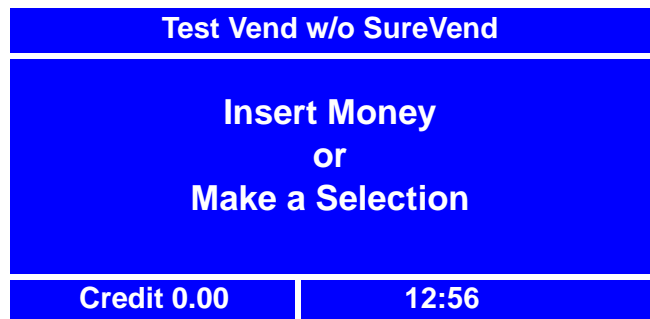
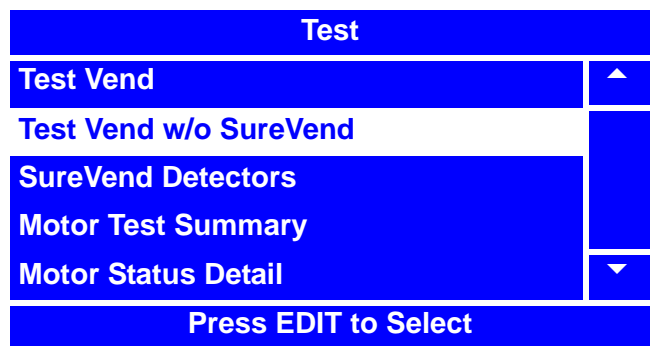
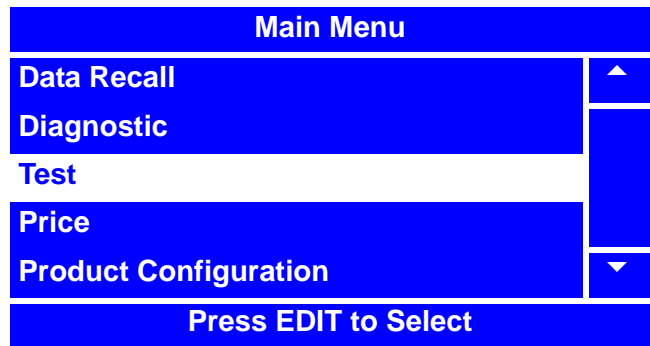

1. Press  until you reach the **Main Menu**, then use  or  to select **Test** and press .
2. In the **Test** menu, use  or  to select **Test Vend w/o SureVend** and press .
3. Make a selection (Ex. 1-0-3), then press the **OK** button.
4. The merchandiser will dispense the selection and return to the original **Test Vend w/o SureVend** menu.
5. Test vend another selection, or press  once to return to the **Test** menu or twice to return to the **Main Menu**.

NOTE



If Merchant™ door is shut while the menu is on the **Test Vend** or the **Test Vend w/o SureVend** screens, the screen will be displayed until one **Test Vend** or **Test Vend w/o SureVend** is completed.

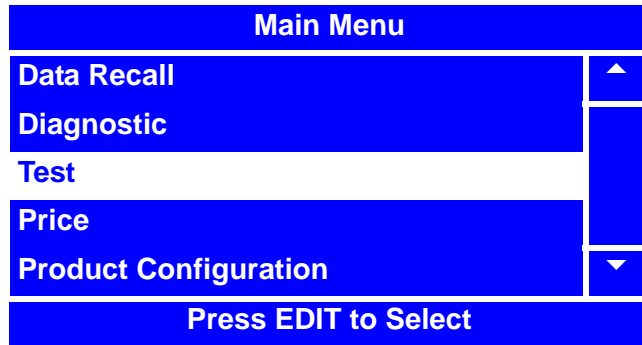

Test SureVend™ Calibration

1. Press  until you reach the **Main Menu**
Menu, then use  or  to select **Test**, and press .



2. In the **Test** menu, use  or  to select **SureVend Calibration** and press .

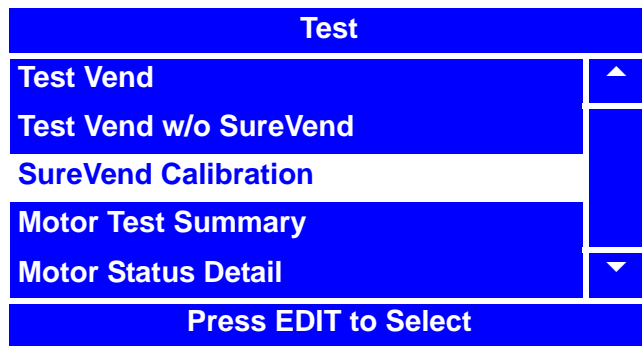

3. The **SureVend Calibration** screen will display the **Calibration Values** as the machine cycles through the SureVend Calibration test.

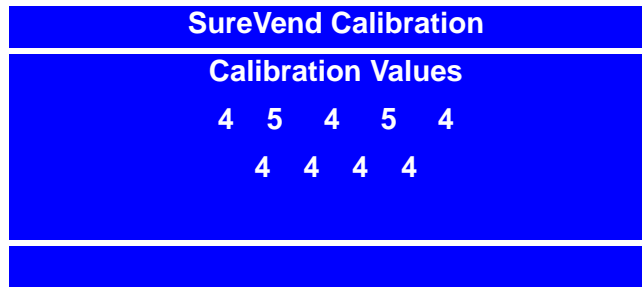









NOTE

The first sensor calibration value shown in the top line of the calibration values is for the sensor which is located in the back of the merchandiser, farthest from the front door. The last sensor calibration value shown in the bottom line of the calibration values is for the sensor which is located in the front, closest to the front door.





The calibration values indicate “gain”. The lower calibration (gain) values are desirable. (*Optimal range is 4*). High calibration (gain) values indicate a problem with the sensor.

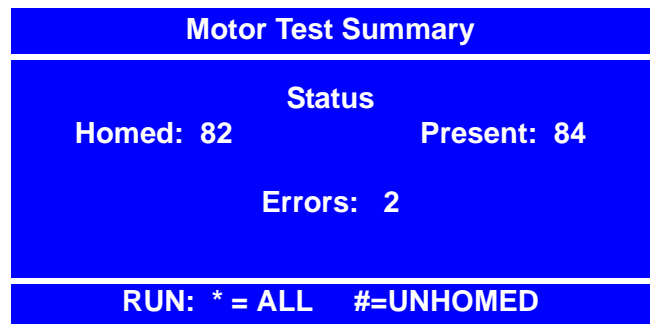
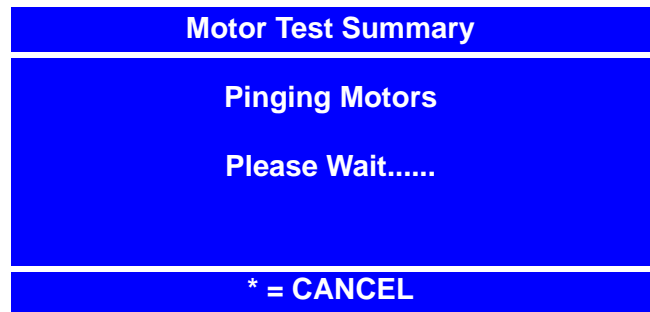
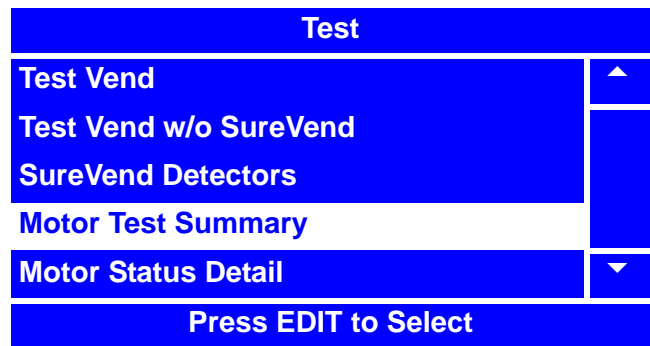
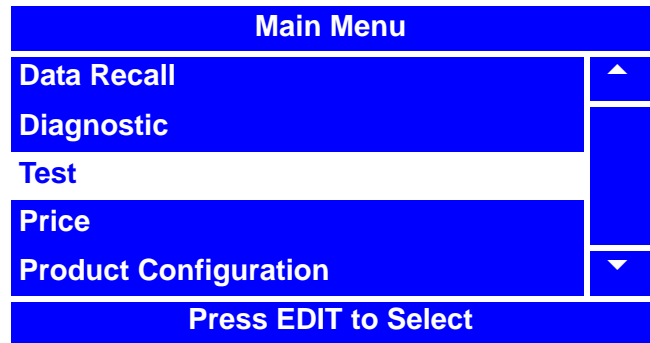

Testing the Motors - Motor Test Summary

1. Press  until you reach the **Main Menu**, then use  or  to select **Test** and press .
2. In the **Test** menu, use  or  to select **Motor Test Summary** and press .
3. The **Motor Test Summary** screen will appear, and will cycle through one screen while motors are being pinged.
4. The **Motor Test Summary** status screen will then appear, indicating information on homed and present motors and indicating errors. If any motors are unhomed or have any other error status, they will be indicated as **Errors**. If this is the case, you will need to home the motor(s.) See "Homing the Motors - Motor Status Detail" on page 86.
5. Press  once to return to the **Test** menu, or twice to return to the **Main Menu**.



Homing the Motors - Motor Status Detail

1. Press  until you reach the **Main Menu**, then use  or  to select **Test**, and press .

2. In the **Test** menu, use  or  to select **Motor Status Detail** and press .

3. In the **Motor Status Detail** menu, select the tray where the product spiral with the motor needing homing is located.

NOTE

In the **Tray X** menu, the product spirals with homed motors will be indicated with an “H” in the line adjacent to the spiral number(s).

4. In the **Tray X** menu, select the product spiral number where the motor needing homing is located.

NOTE

The **Tray X** menu indicates not only the homed motor status, but also:

- If spiral is a FIFO group member
- If spiral is coupled with another spiral
- If there is an error present for the spiral
- If spiral is part of a winner combo
- If spiral is a token member
- If spiral is a time of day member

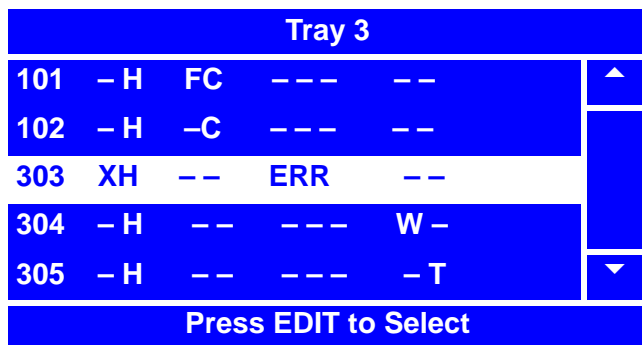
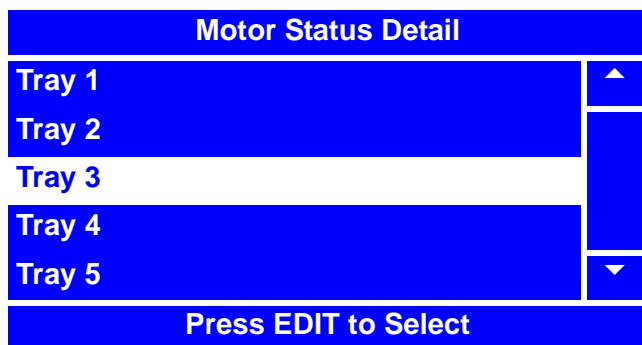
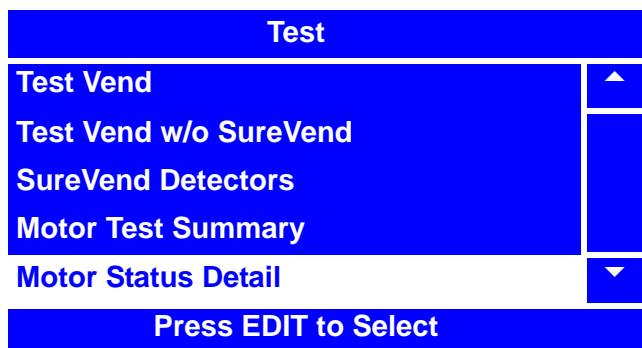
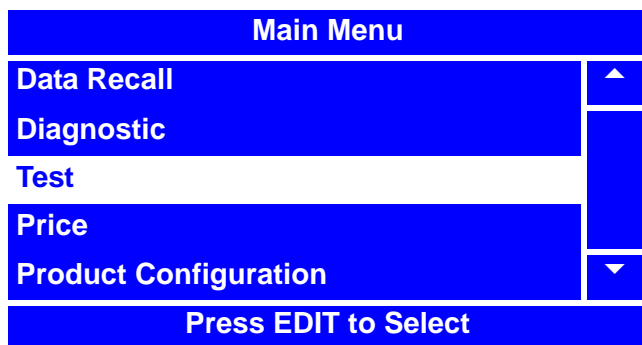

NOTE

Refer to the figure of “Motor Status Detail Menu Screen” on page 88 and the “Table: Motor Status Detail Menu Screen” on page 88 (at the end of this procedure) for location of above information and for more information.

Homing the Motors - Motor Status Detail (continued)

5. In the **XXX** menu, choose **Press START**

To Home. and press  once.

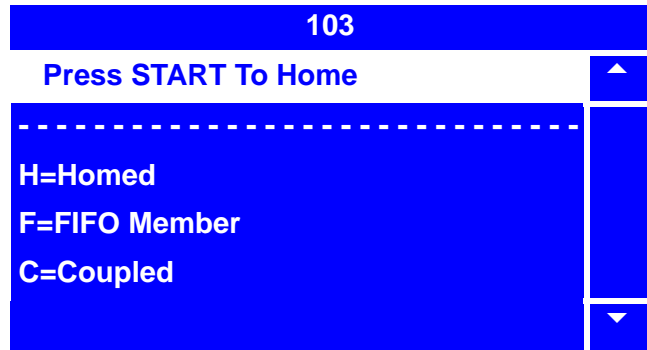

6. While motor is being homed, the screen will change to **"HOMING PLEASE WAIT."**

7. After motor is homed, the screen will cycle to the **XXX** menu, and will indicate that the motor is homed by displaying **"H=Homed."**

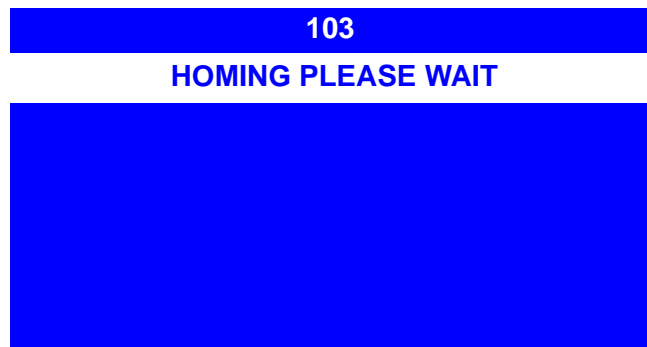

8. Press  once to return to the **Tray X** menu. The line for the product spiral number you originally selected to be homed should indicate **"- H - - - - -"**

9. You may then select a different product spiral for motor homing, or press  to return to the **Motor Status Detail**.

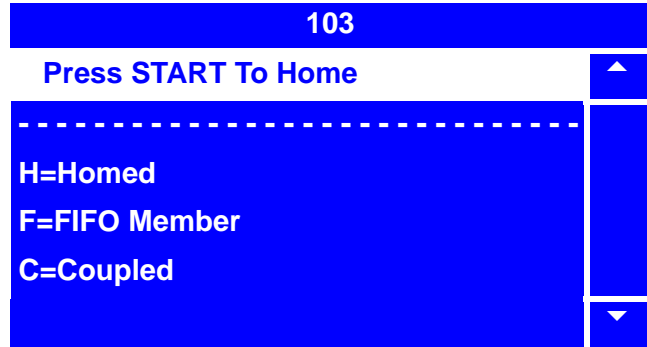

10. From the **Motor Status Detail** menu, you may select a different tray where another product spiral with a motor needing homing is located, or you may press

 once to return to the **Test** menu or twice to return to the **Main Menu**.

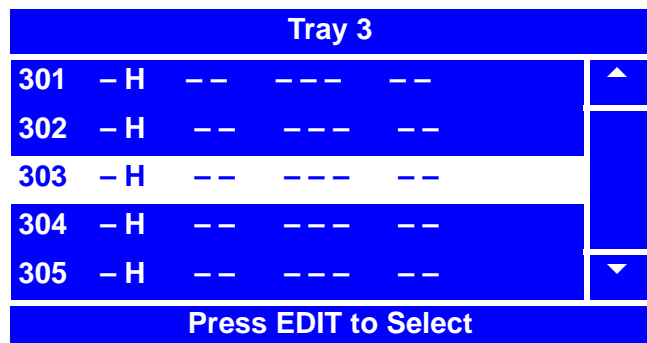

Homing the Motors - Motor Status Detail (continued)

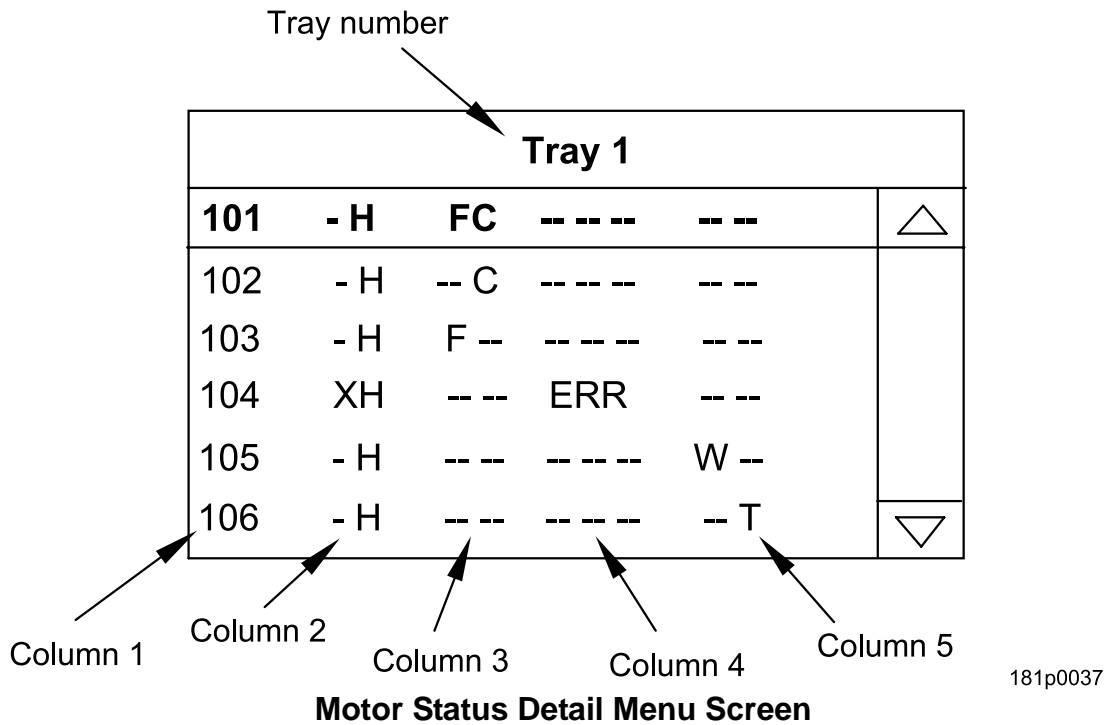









Table: Motor Status Detail Menu Screen

	First Field	Second Field
Tray number	Indicates tray number.	
Column 1	Indicates spiral number.	
Column 2	“X” indicates the spiral motor is present, but not configured.	“H” indicates that spiral motor is homed. An absence of an “H” indicates that the spiral motor is NOT homed.
Column 3	“F” indicates spiral is a FIFO member (see page 104).	“C” indicates spiral is coupled (see page 108).
Column 4	“ERR” indicates error is present for the spiral.	
Column 5	“W” indicates spiral is a Winner member (see page 122), Token member (see page 128) or a Combo member (see page 125).	“T” indicates spiral is a Time of Day event member (see page 109).

Test the Coin Return Motor

1. Press  until you reach the **Main Menu**, then use  or  to select **Test** and press .

2. In the **Test** menu, use  or  to select **Coin Return Motor**, then press .

3. Press  to begin the test. The **Coin Return Motor** status screen will cycle from “**Idle**” to “**Return Change**” for the duration of the test.

NOTE

If the **Coin Return Motor** status screen cycles to **Error** instead of **Return Change**,

exit this procedure by pressing 



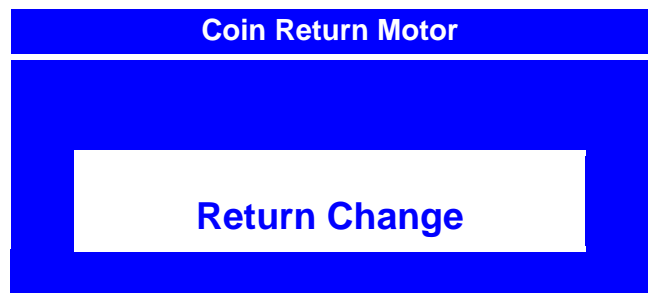
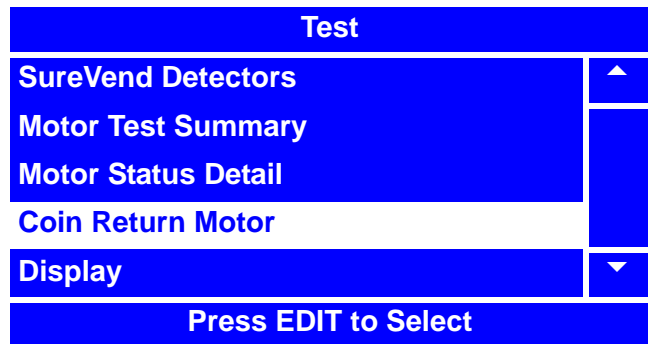
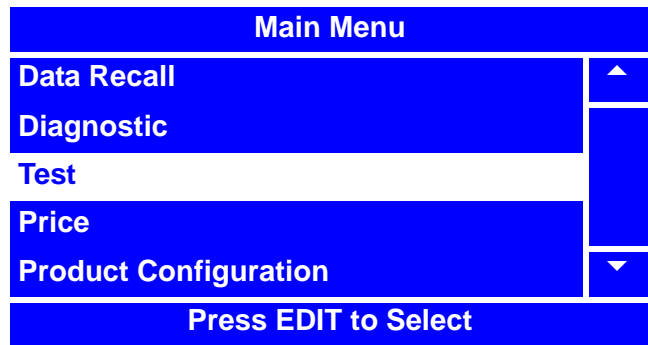

until you reach the **Main Menu**, then follow the procedure to “Check for Errors” on page 78 to further investigate the error.

4. When the test is completed, the **Coin Return Motor** status screen will change back to **Idle**.

5. After the test, press  once to return to the **Test** menu, or twice to return to the **Main Menu**.



Test the Light Relay

1. Press  until you reach the **Main Menu**, then use  or  to select **Test** and press .

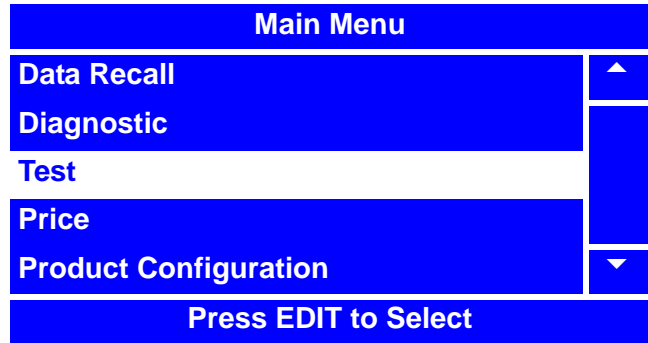

2. In the **Test** menu, use  or  to select **Lighting Relay**, then press .

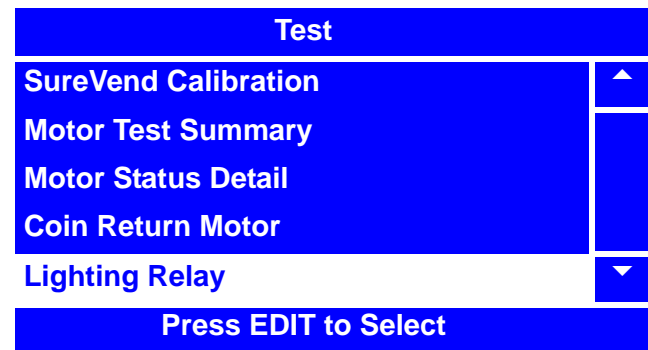

3. Press  to begin the test. The **Lighting Relay** status screen will change from “On” to “Off” and the lights should turn off.

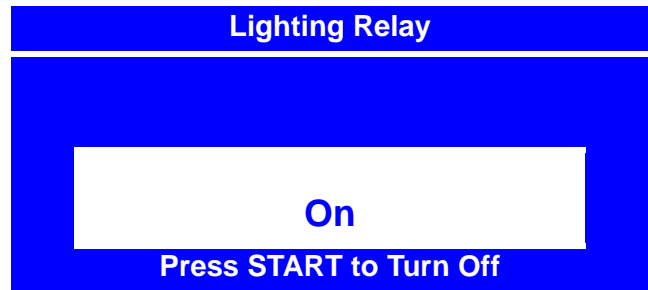



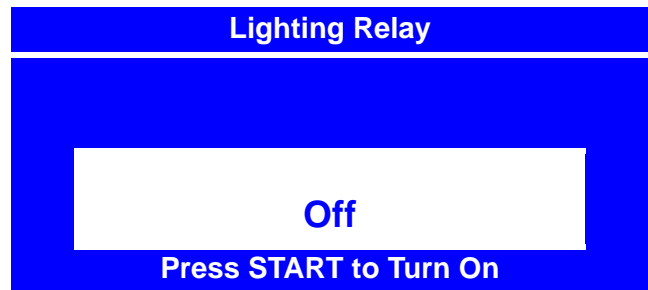

4. Press  again. The **Lighting Relay** status screen will change from “Off” to “On” and the lights should turn back on.





5. After the test, press  once to return to the **Test** menu, or twice to return to the **Main Menu**.

Check the Temperature

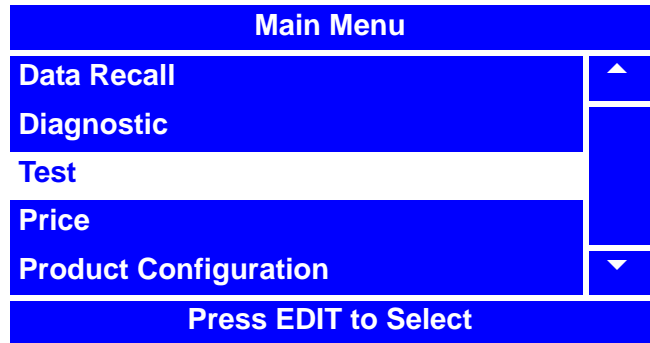
1. Press  until you reach the **Main Menu**, then use  or  to select **Test** and press .



2. In the **Test** menu, use  or  to select **Temperature Sensors**, then press .

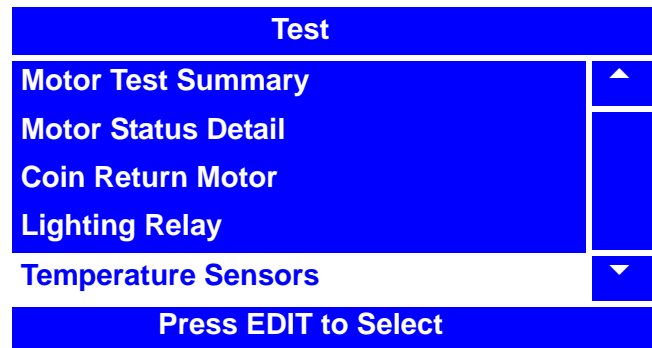

3. In the **Temperature Sensors** screen you can view and test:
- **Cabinet** - This is the temperature inside the cabinet.
 - **Evap** - This is the temperature of the evaporator.
 - **Cond** - This is the temperature of the condenser.

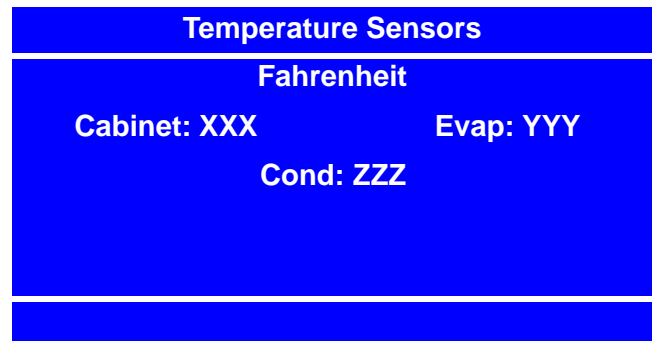

These temperatures are only good for testing the sensors.





4. Press  once to return to the **Test** menu, or twice to return to the **Main Menu**.

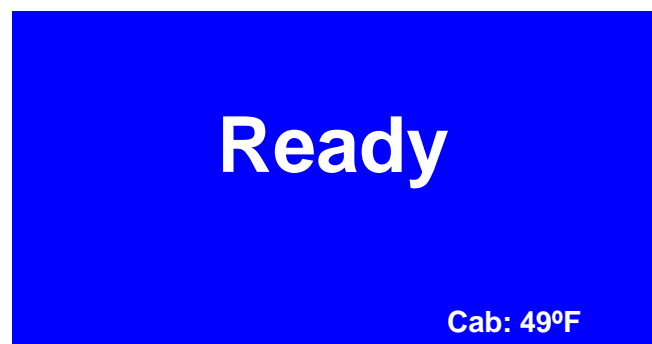

NOTE

The actual running temperatures of the Cabinet, Evaporator, Condenser and the current state of the Compressor can be rotated through by pressing the "OK" key while the door is closed. These temperatures will be displayed in the lower right hand corner of the display.



Test the Display

1. Press  until you reach the **Main Menu**, then use  or  to select **Test**, and press .

2. In the **Test** menu, use  or  to select **Display** and press .

3. Press  repeatedly to cycle through different display test patterns. The display test patterns will reveal any flaw in the display.



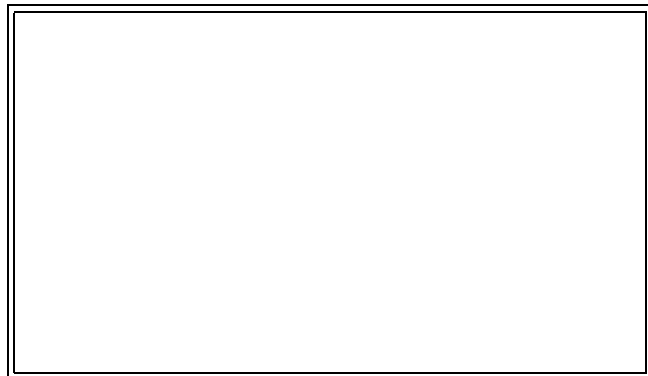
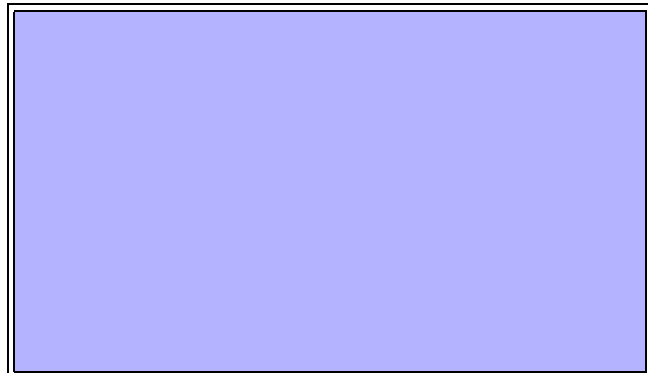
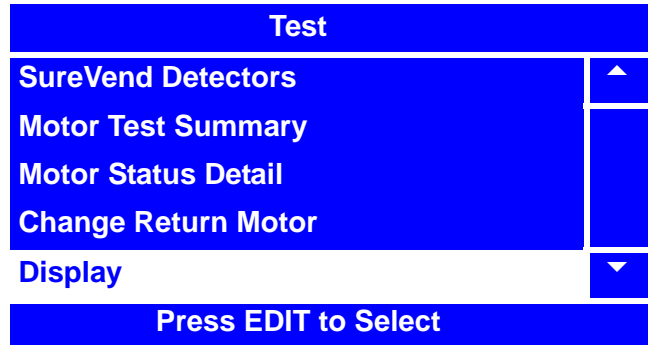
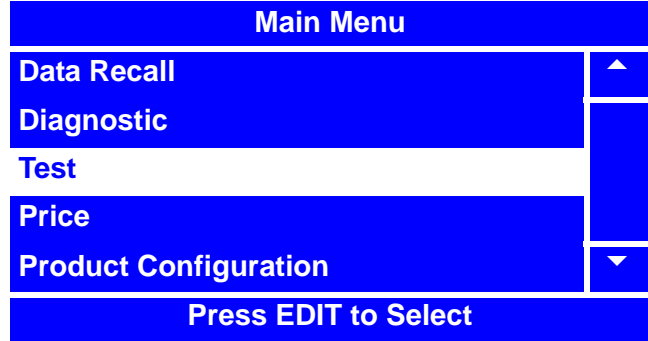

NOTE

If a flaw is detected in the display by performing this test, the display may have to be serviced or replaced.



4. When you have cycled through all of the different display test patterns, the test is complete. Press  once to return to the **Test** menu screen or twice to return to the **Main Menu**.

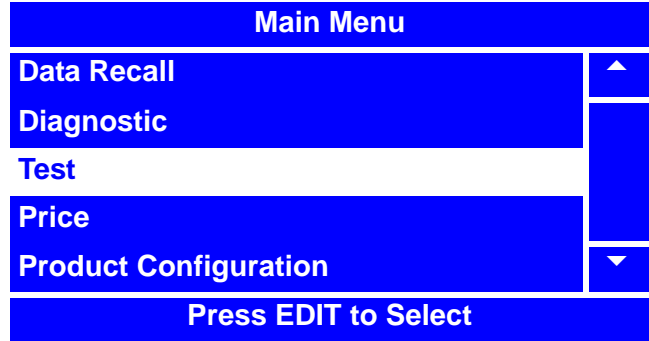

Test the Keypads - Keypad Entry

1. Press  until you reach the **Main Menu**, then use  or  to select **Test** and press .



2. In the **Test** menu, use  or  to select **Keypad Entry** and press .

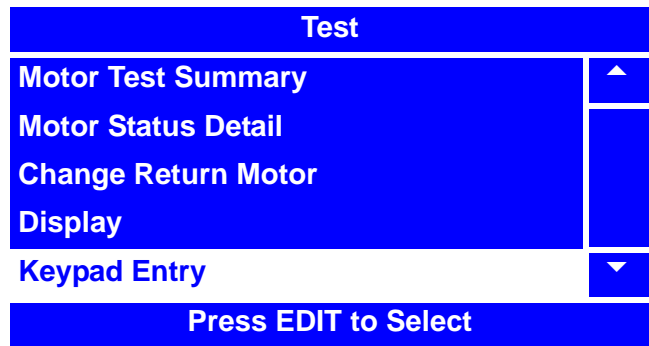

3. In the **Keypad Entry** screen, press any key on the main or service keypads. The key you pressed should display (or if pressing a special button, refer to the list below). On the Main Keypad:

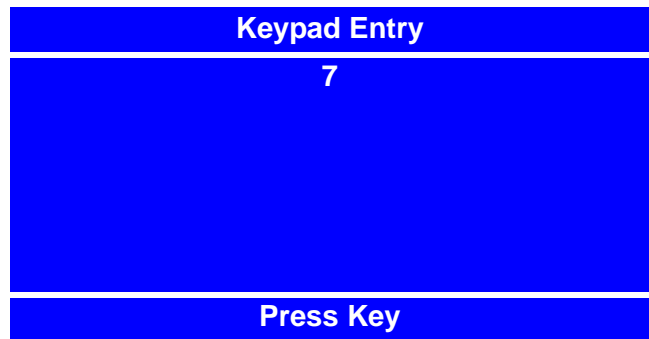

- If you press , you should see “C”.
- If you press the Coin Return button, you should see “R”.
- If you press the OK button, you should see “S”.

On the Service Keypad:

- If you press , you should see

- If you press , you should see





NOTE



If the key you have pressed does not display, the keypad may have to be serviced or replaced.

4. When you have finished testing the keypad(s), press  once to return to the **Test** menu or three times to return to the **Main Menu**.

Programming: Prices



Set Prices for Individual Selections

1. Press  until you reach the **Main Menu**, then use  or  to select **Price** and press .

2. In the **Price** menu, use  or  to select **Individual Prices** and press .

NOTE

The **Individual Prices** menu lists all selections programmed for the merchandiser. Notice how the status (bottom) line displays the current price of the highlighted selection.

3. Use  or  to highlight a selection and press  to set its price.





4. Using the number keys on either keypad, enter a price for the selection. If the price is less than 10,000.00, use leading zeros. The arrow keys will reposition the cursor.

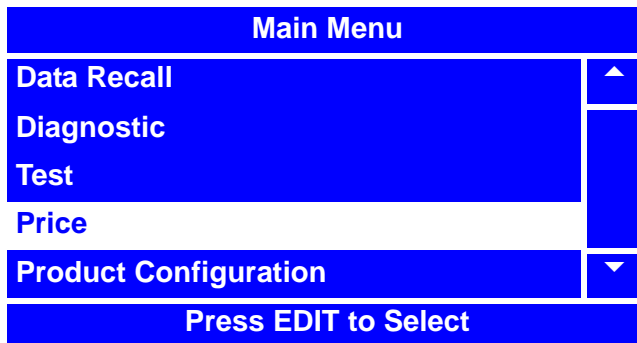

5. Press  to return to the **Individual Prices** menu. Verify that the new price displays in the status (bottom) line when the selection is highlighted.

6. Press  once more to return to the **Price** menu or twice to return to the **Main Menu**.



Set One Price for the Entire Machine

1. Press  until you reach the **Main Menu**, then use  or  to select **Price** and press .

2. In the **Price** menu, use  or  to select **Entire Machine** and press .

TIP: If most selections will have the same price, use this feature to quickly set the entire machine to that price, then go to *“Set Prices for Individual Selections” on page 94* to adjust the prices for individual selections.





3. Using the number keys on either keypad, enter a price for the entire machine. If the price is less than 10,000.00, use leading zeros. The arrow keys will reposition the cursor.

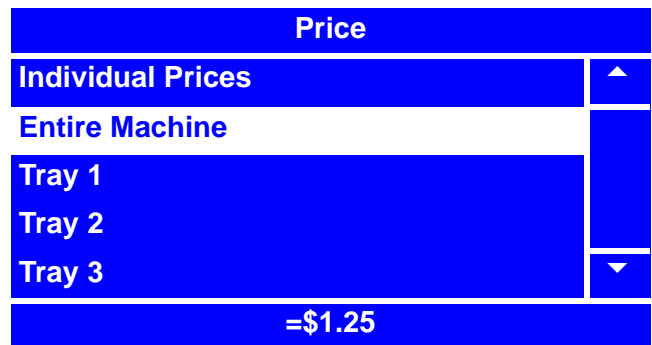
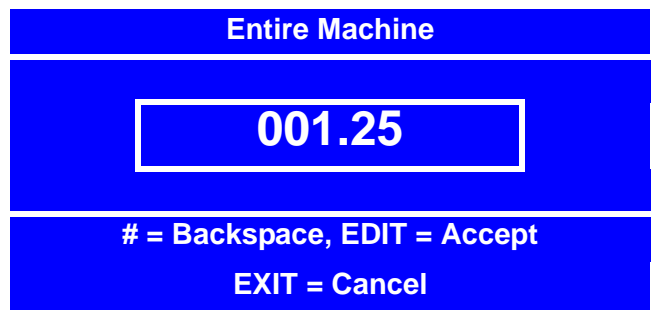
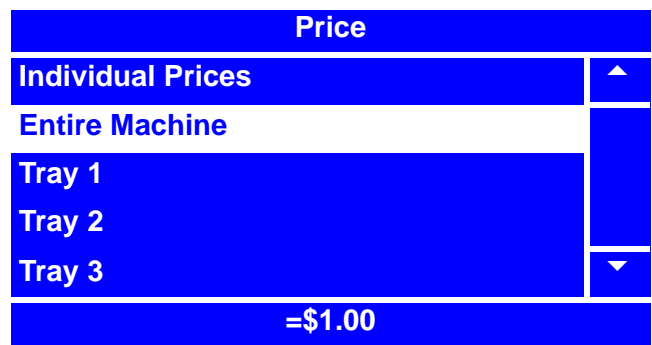
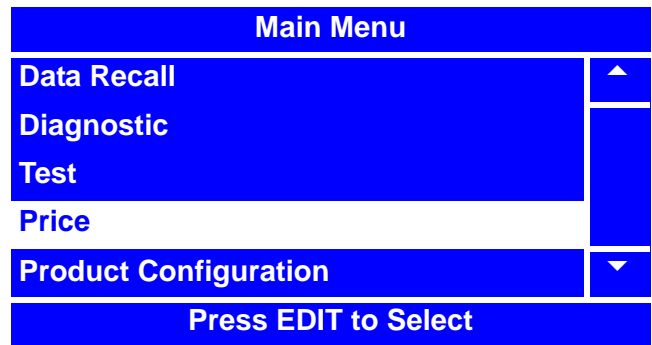

4. Press  to set the new price and return to the **Price** menu. Verify that the new price displays in the status (bottom) line.

5. Press  once more to return to the **Main Menu**.



Set Prices by Trays

1. Press  until you reach the **Main Menu**, then use  or  to select **Price** and press .

2. In the **Price** menu, use  or  to select the tray number you wish to set the price for and press .

TIP: If most selections on the same tray will have the same price, use this feature to quickly set the entire tray to that price, then go to “Set Prices for Individual Selections” on page 94 to adjust the prices for individual selections.

3. Using the number keys on either keypad, enter a price for the selected tray. If the price is less than 100.00, use leading zeros. The arrow keys will reposition the cursor.



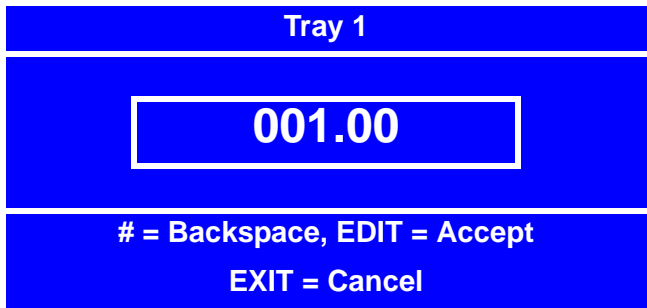
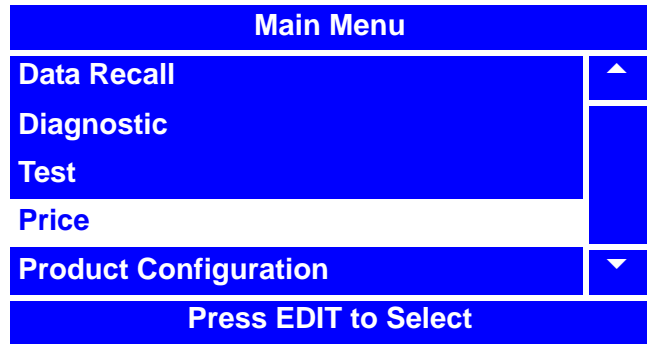

4. Press  to set new price and return to the **Price** menu. Verify that the new price displays in the status (bottom) line.

5. Press  once more to return to the **Main Menu**.





Programming: Product Configuration

View Configuration Version

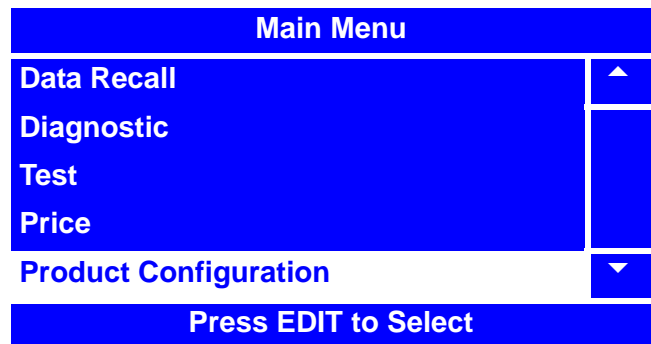
- Press  until you reach the **Main Menu**, then use  or  to select **Product Configuration** and press .



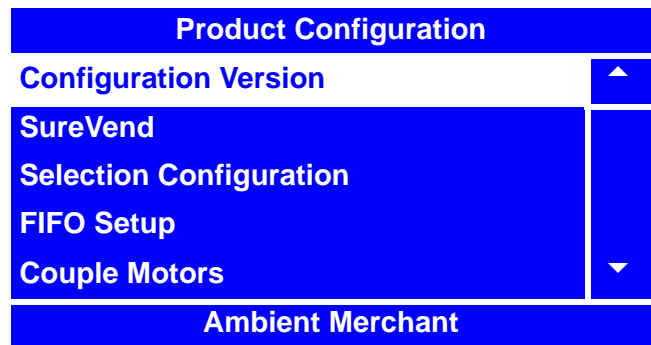

- In the **Product Configuration** menu, use  or  to select **Configuration Version**. The configuration of the merchandiser will be displayed on the status (bottom) line of the **Product Configuration** menu.

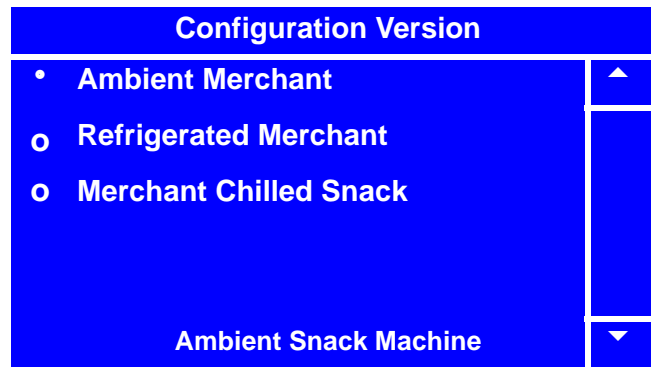

- Press  to access the **Configuration Version** screen. This screen will also display the current configuration version indicated by the filled in circle and shown at the bottom of the screen.



- In the **Configuration Version** menu, use  or  to select the desired configuration.

- Press  once to return to the **Product Configuration** menu, or twice to return to the **Main Menu**.













DEFINITIONS

Ambient Merchant - No temperature control. This setting must not be used when selling perishable items.

Refrigerated Merchant -The target temperature is fixed at +36°F (2°C). Should be used when selling perishable items that require Health Control. See page 172 for Health Control information.



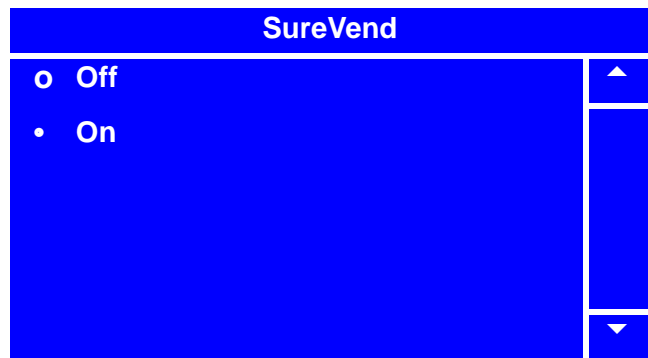
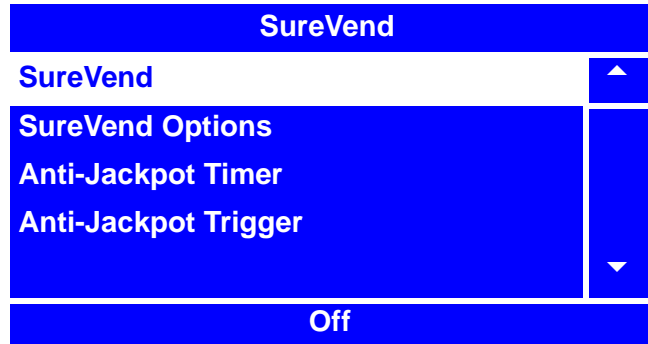
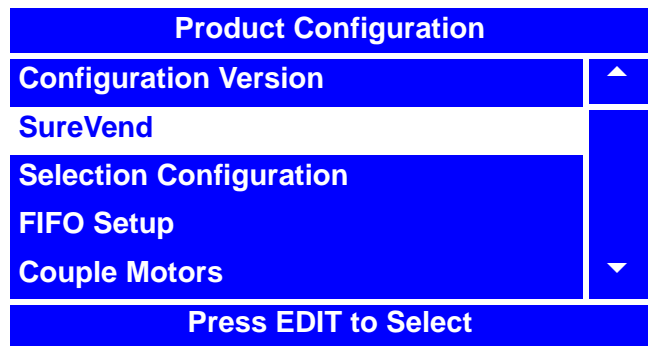
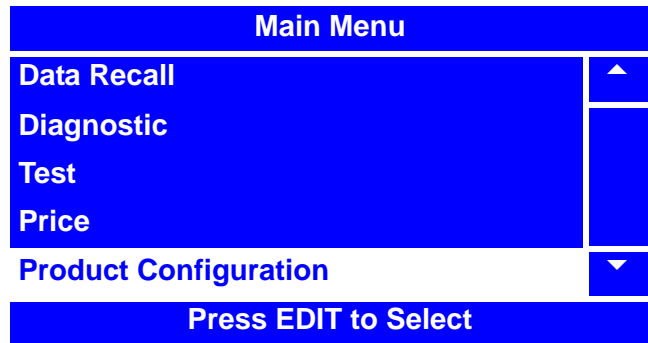

Merchant Chilled Snack - The target temperature is settable from +49° to +69°F (9° to 20°C). This setting must not be used when selling perishable items.

Turn SureVend™ On and Off

- Press  until you reach the **Main Menu**, then use  or  to select **Product Configuration** and press .
- In the **Product Configuration** menu, use  or  to select **SureVend**.
- In the **SureVend** menu, use  or  to select **SureVend**.
- A second **SureVend** menu will appear. Use  or  to select the status (**Off** or **On**.) The selection is the one with the filled-in circle. Press  to lock in the selection.
- The screen will cycle back to the first SureVend menu. Verify that the status of SureVend™ (**Off** or **On**) is displayed in the status (bottom) line of this **SureVend** menu.
- Press  once to return to the **Product Configuration** menu or twice to return to the **Main Menu**.



Set SureVend™ Options

1. Press  until you reach the **Main Menu**, then use  or  to select **Product Configuration** and press .

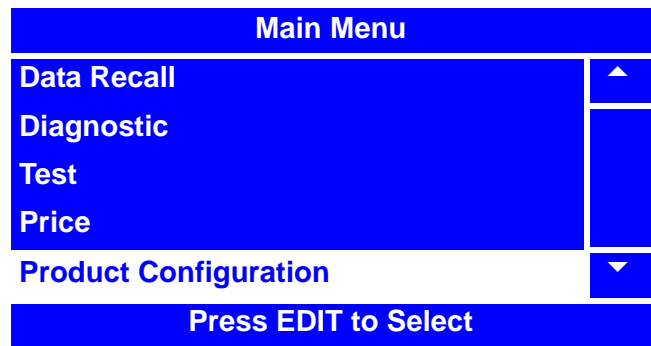

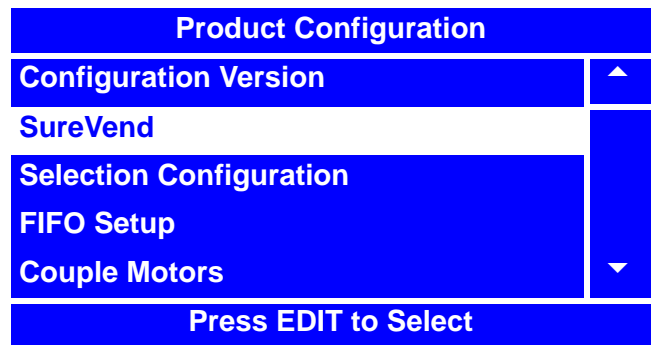

2. In the **Product Configuration** menu, use  or  to select **SureVend**.





NOTE

The status (**Off** or **On**) of SureVend™ must be **On** for the **SureVend Options** selection to show up on the menu screen and be accessed. For instructions on setting SureVend™ status (**Off** or **On**), see “Turn SureVend™ On and Off” on page 98.

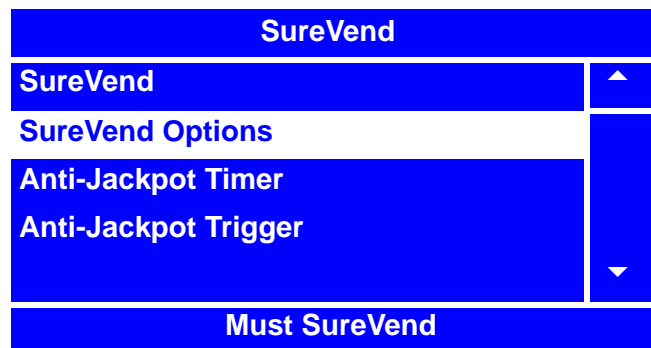
3. In the **SureVend** menu, use  or  to select **SureVend Options**. The status of **SureVend Options** (**Option SureVend** or **Must SureVend**) will display in the status (bottom) line of the **SureVend** menu. Press  to access the **SureVend Options** menu to change status, if desired.



4. In the **SureVend** menu, use  or  to select **Option SureVend** or **Must SureVend**. The selection is the one with the filled-in circle. Press  to lock in your selection and return to the **SureVend** menu.

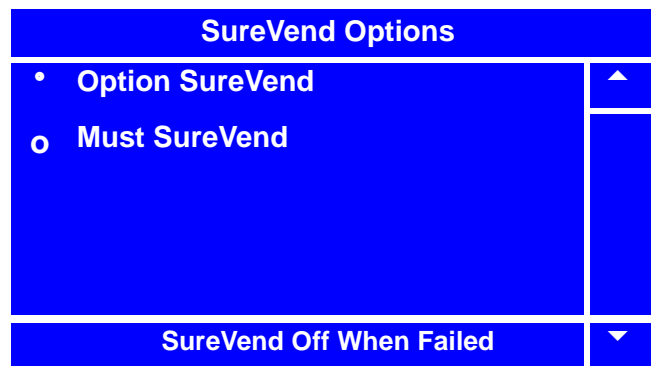



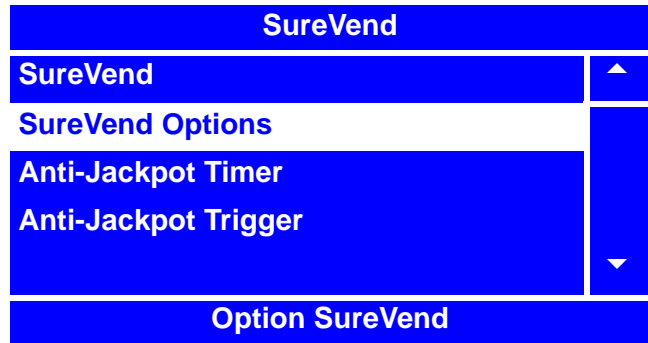

Set SureVend Options (continued)

- Verify that the selection you made is now displayed in the status (bottom) line of the **SureVend** menu when **SureVend Options** is selected.



- Press  once to return to the **Product Configuration** menu or twice to return to the **Main Menu**.

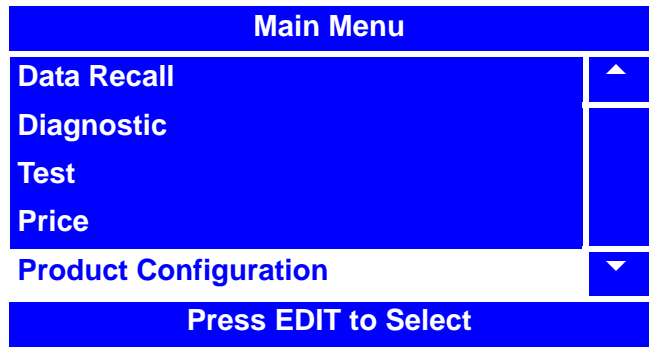

Set SureVend™ Anti-Jackpot Timer

1. Press  until you reach the **Main Menu**, then use  or  to select **Product Configuration** and press .



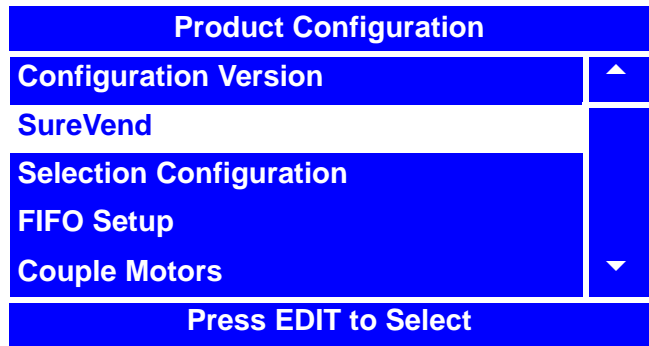

2. In the **Product Configuration** menu, use  or  to select **SureVend** and press .



NOTE

The status (**Off** or **On**) of SureVend™ must be **On** for the **Anti-Jackpot Timer** selection to show up on the menu screen and be accessed. For instructions on setting SureVend™ status (**Off** or **On**), see "Turn SureVend™ On and Off" on page 98.

3. In the **SureVend** menu, use  or  to select **Anti-Jackpot Timer**. The setting of **Anti-Jackpot Timer** will display on the status (bottom) of the **SureVend** menu. Press  to access the **Anti-Jackpot Timer** menu to change status, if desired.

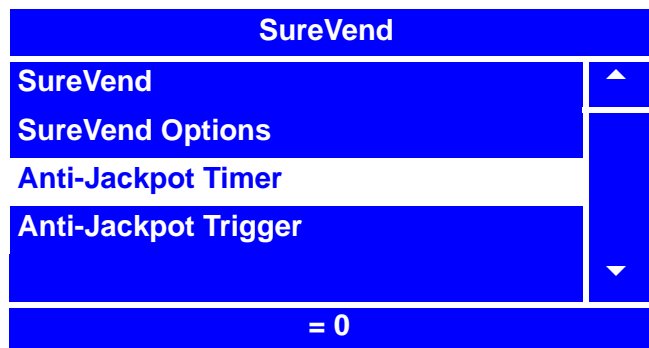



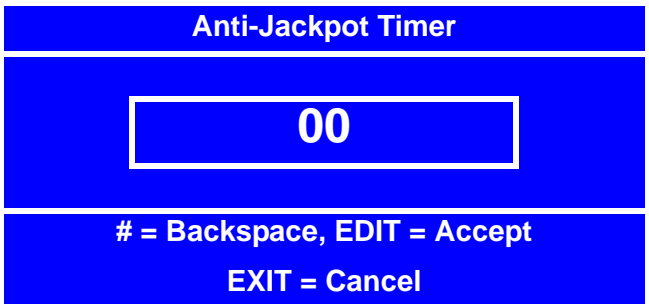

4. Using the number keys on either keypad, enter a setting for **Anti-Jackpot Timer**. If the setting is less than 10, use leading zeros: Example: press 0-5 to set the setting for 5. If you enter more than two numbers, the display will scroll back to the first digit.



5. Press  to save setting and return to the **SureVend** menu. Verify that the new setting is now displayed in the status (bottom) line of the **SureVend** menu.

6. Press  once to return to the **Product Configuration** menu or twice to return to the **Main Menu**.



Set SureVend™ Anti-Jackpot Trigger

1. Press  until you reach the **Main Menu**, then use  or  to select **Product Configuration** and press .

2. In the **Product Configuration** menu, use  or  to select **SureVend**.

NOTE

The status (**Off** or **On**) of SureVend™ must be **On** for the **Anti-Jackpot Trigger** selection to show up on the menu screen and be accessed. For instructions on setting SureVend™ status (**Off** or **On**), see “Turn SureVend™ On and Off” on page 98.

3. In the **SureVend** menu, use  or  to select **Anti-Jackpot Trigger**. The setting of **Anti-Jackpot Trigger** will display in the status (bottom) line of the **SureVend** menu. Press  to access the **Anti-Jackpot Trigger** screen to change status, if desired.



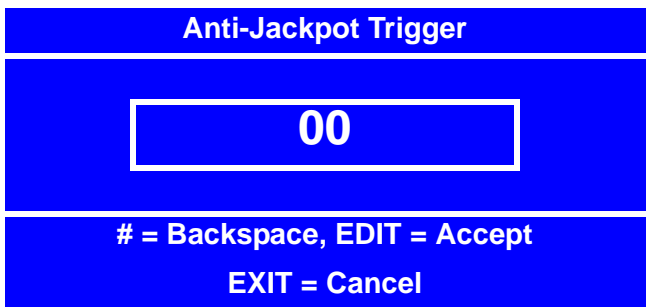
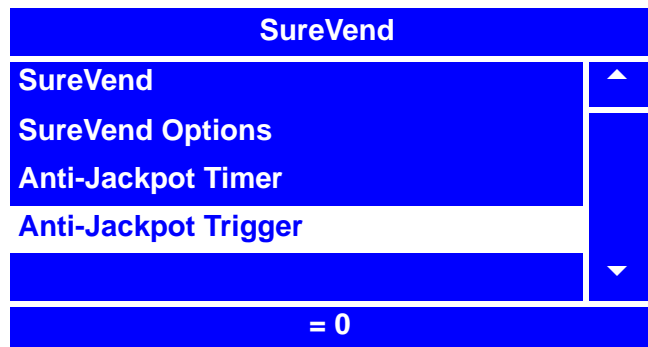
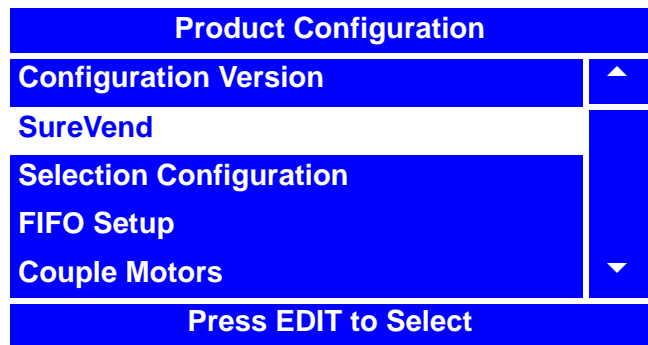
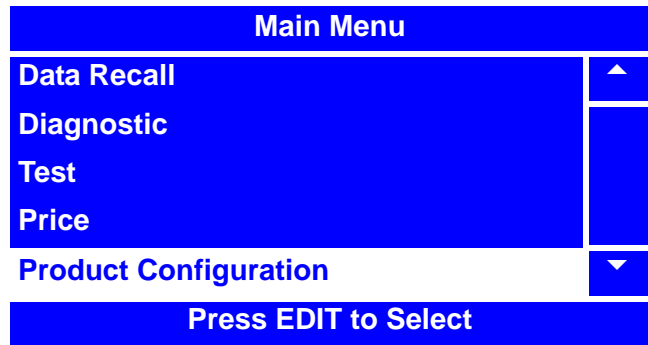

4. Using the number keys on either keypad, enter a setting for **Anti-Jackpot Trigger**. If the setting is less than 10, use leading zeros: Example: press 0-5 to set the setting for 5. If you enter more than two numbers, the display will scroll back to the first digit.

5. Press  to save setting and return to the **SureVend** menu. Verify that the new setting is now displayed in the status (bottom) line of the **SureVend** menu.



6. Press  once to return to the **Product Configuration** menu or twice to return to the **Main Menu**.

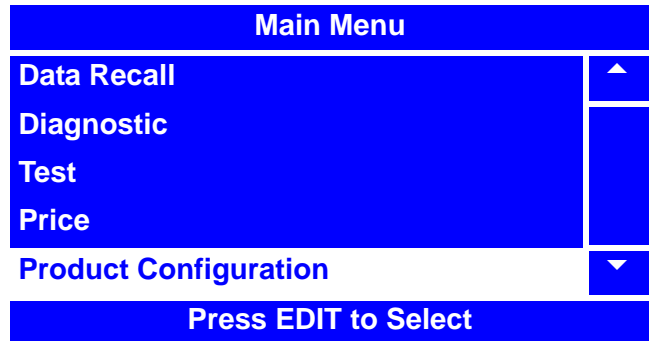

Selection Configuration

1. Press  until you reach the **Main Menu**, then use  or  to select **Product Configuration** and press .



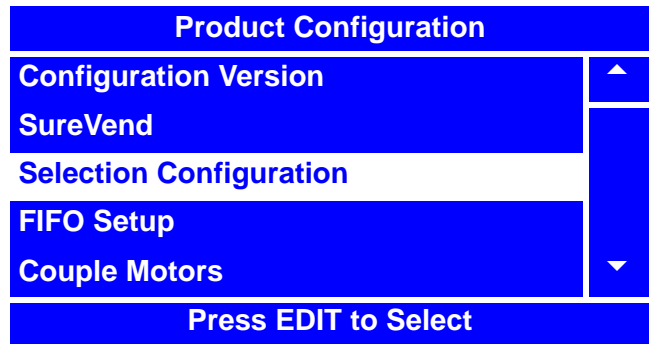

2. In the **Product Configuration** menu, use  or  to select **Selection Configuration** and press .



NOTE

A screen that indicates “pinging” will appear momentarily.

3. In the **Selection Configuration** menu, use  or  to select the product(s) you wish to configure or unconfigure.

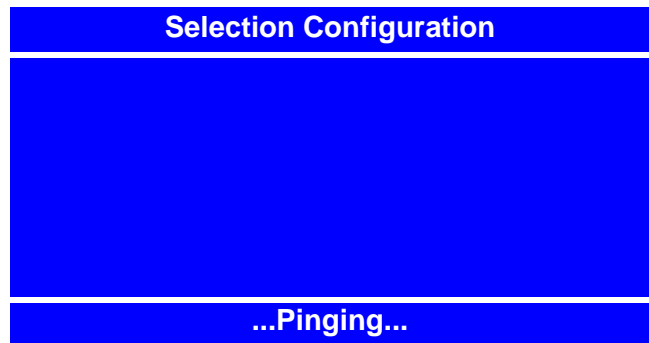

4. Press  to remove or add the “X”(s) from the box(es) preceding the product number(s).

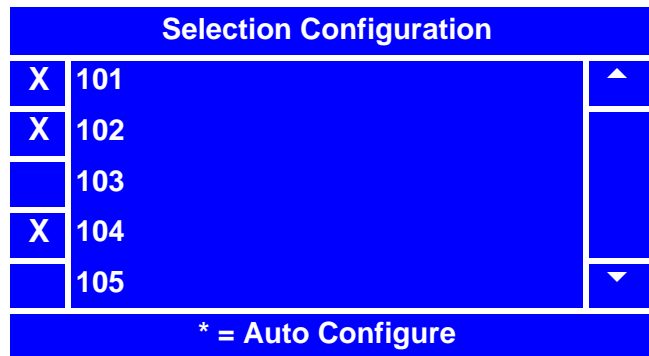

NOTE:

By pressing , you will auto configure (ie. all selections that have spirals physically connected will configure).





5. Press  once to return to the **Product Configuration** menu, or twice to return to the **Main Menu**.

FIFO (First In, First Out)



FIFO (First In, First Out) allows you to program your Merchant™ to run selections as a single selection. No matter which selection ID of the group is entered, the Merchant™ will vend round-robin from the group of spirals, skipping selections that are out-of-service. This feature can provide a First-In-First-Out for perishable foods. It also helps to prevent one spiral of duplicate selections to go empty before the others of the same selection.

Note: Ensure that all selections chosen for each FIFO group are the same price.

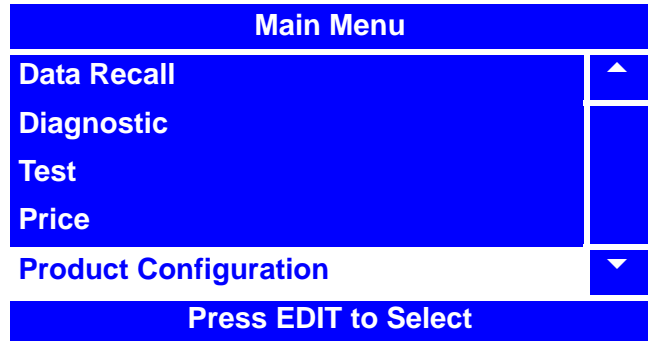

FIFO Setup - Adding Groups

1. Press  until you reach the **Main Menu**, then use  or  to select **Product Configuration** and press .



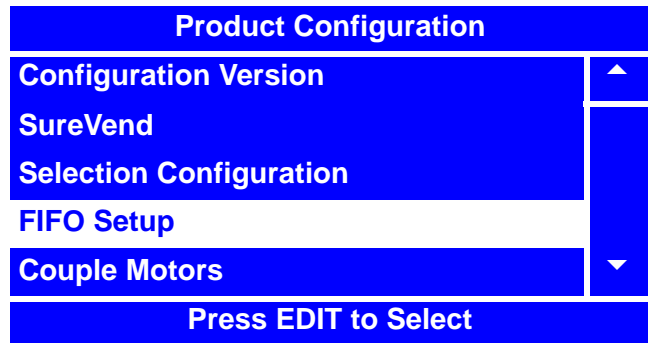

2. In the **Product Configuration** menu, use  or  to select **FIFO Setup** and press .



3. In the **FIFO Setup** menu, use  or  to select **Add Group 1** and press .



4. In the **Add Group 1** menu, use  or  to select the product(s) you wish to add or delete from the group by pressing  to remove or add the "X"(s) next to the products.

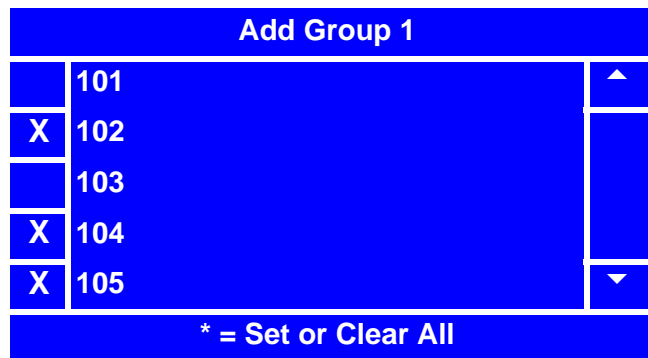

NOTE

By pressing , you are able to quickly remove or add the "X"(s) from all listed products for the group.

FIFO Setup - Adding Groups (continued)

5. Press  once to return to the **FIFO Setup** menu.

NOTE

Once you have set up the first group for **FIFO Setup**, you will now have additional choices on the **FIFO Setup** menu.

For adding additional groups, follow steps 3 thru 5 on the preceding page.

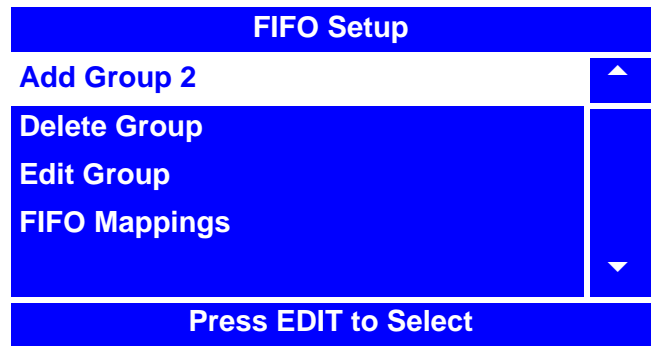

FIFO Setup - Deleting Groups

1. From the **FIFO Setup** menu, use  or  to select **Delete Group** and press .

2. Select which group you wish to delete and press .

3. You will see a warning screen reminding you that once accomplished, the deletion cannot be undone.

4. Press  to delete the selected group.

– OR –

- Press  to cancel this action.

NOTE

Pressing  to cancel will return you directly back to the **FIFO Setup** menu if all groups have been deleted. If there are more groups remaining, you will return to the **Delete Group** menu screen.

5. If you are at the **Delete Group** menu, press  to return to the **FIFO Setup** menu.

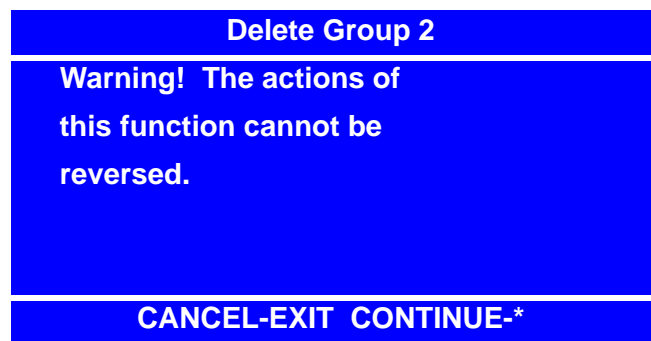
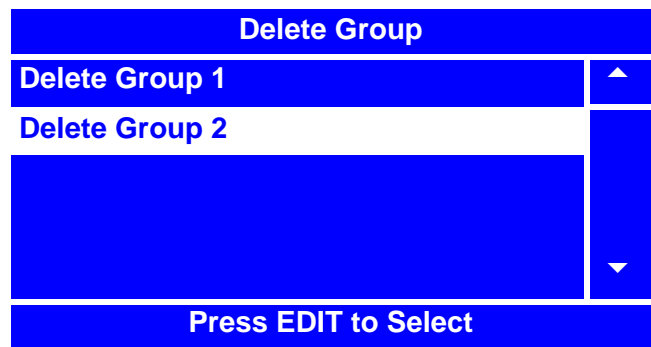
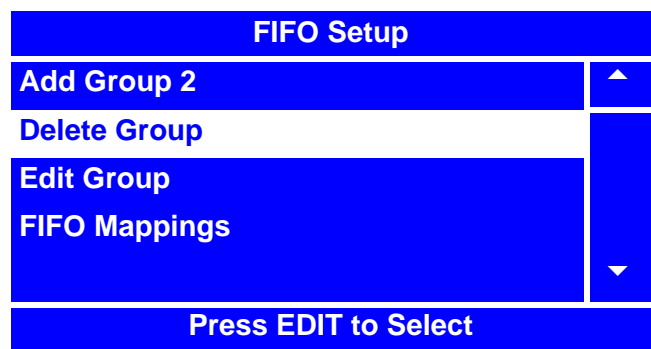

FIFO Setup - Editing Groups

1. From the **FIFO Setup** menu, use

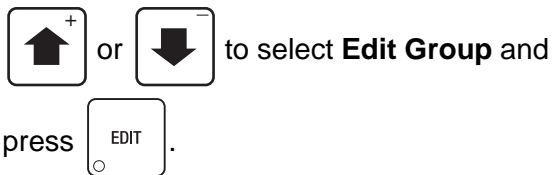

2. Using or , select which group you wish to edit and press .

3. In the **Edit Group (#)** menu, select the product(s) you wish to add or delete from the group by using the or to select a product and then pressing to remove or add the “X”(s) next to the products.

NOTE

By pressing , you are able to quickly remove or add the “X”(s) from all listed products for the group.

4. Press once to return to the **Edit Group** menu.

5. You may now choose another group to edit from this menu, or press again to return to the **FIFO Setup** menu.

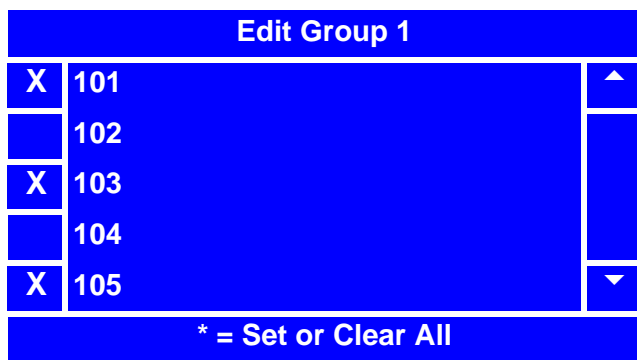
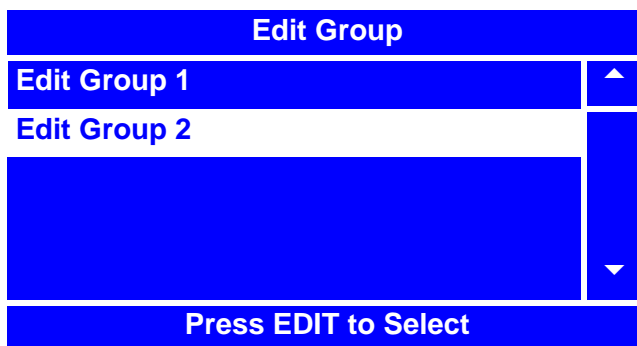
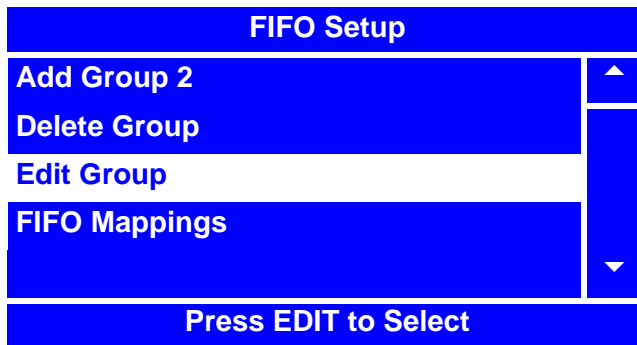

NOTE

When adding or editing groups, if only one product selection number is selected, no group will be added, or the group being edited will be deleted.

FIFO Setup - View FIFO Mappings

- From the **FIFO Setup** menu, use

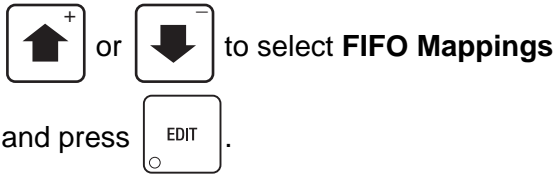

- In the **FIFO Mappings** menu, use

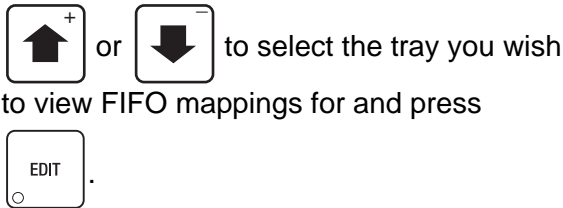

- The **Tray X FIFO Selections** screen will appear for the tray which you selected, indicating which products are mapped into which groups.

NOTE

FIFO mappings are unable to be changed in this screen. To change FIFO mappings for products, you must use the steps outlined in “FIFO Setup - Adding Groups” on page 104, “FIFO Setup - Deleting Groups” on page 105 and/or “FIFO Setup - Editing Groups” on page 106.

- After viewing and making note of a particular product tray’s FIFO mappings,

press **EXIT** once to return to the **FIFO Mappings** menu, twice to return to the **FIFO Setup** menu, or continue to press

EXIT until you reach the **Main Menu**.

FIFO Setup	
Add Group 2	▲
Delete Group	
Edit Group	
FIFO Mappings	
	▼
Press EDIT to Select	

FIFO Mappings	
Tray 1 FIFO Selections	▲
Tray 2 FIFO Selections	
Tray 3 FIFO Selections	
Tray 4 FIFO Selections	
Tray 5 FIFO Selections	▼
Press EDIT to Select	





Tray 4 FIFO Selections		
101	Group 1	▲
102	N/A	
103	Group 2	
104	Group 1	
105	N/A	
106	Group 2	▼

Couple Motors



The Merchant™ can be set to couple adjacent product tray motors to vend together. There are times when you will need to set adjacent motors on a tray to vend together, as in the case of vending wide products. Follow this procedure to electronically couple adjacent motors.

NOTE

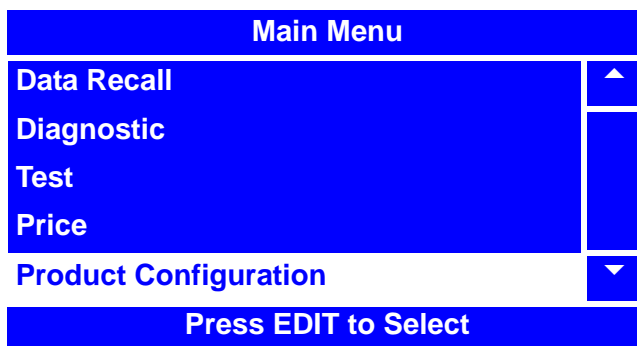

Once coupled, motors will never run separately. This includes when testing from the Motor Test Summary (page 85) and/or the Motor Status Detail (page 86) menus.

- Press  until you reach the **Main Menu**, then use  or  to select **Product Configuration** and press .

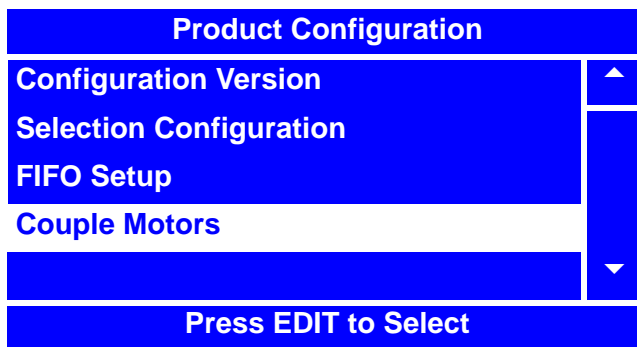

- In the **Product Configuration** menu, use  or  to select **Couple Motors** and press .



- In the **Couple Motors** menu, you will see a list of all Motor Pairs that are able to be coupled to vend together. Select the Motor Pair(s) you wish to couple by using the  or  to select a Motor Pair and then pressing  to remove or add the "X"(s) next to the Motor Pair(s).

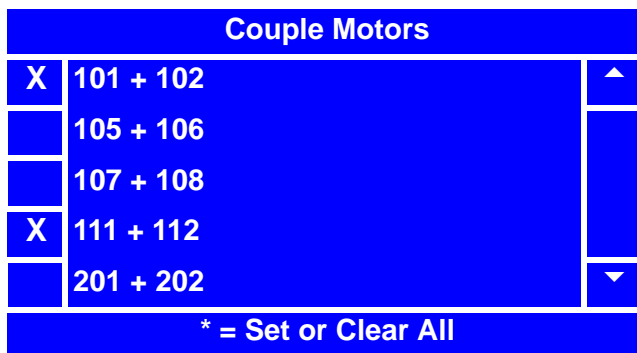

NOTE





By pressing , you are able to quickly remove or add the "X"(s) from all listed Motor Pairs.

- Press  once to return to the **Product Configuration** menu or twice to return to the **Main Menu**.



Special Vend Modes

Timed Events-Time of Day Events

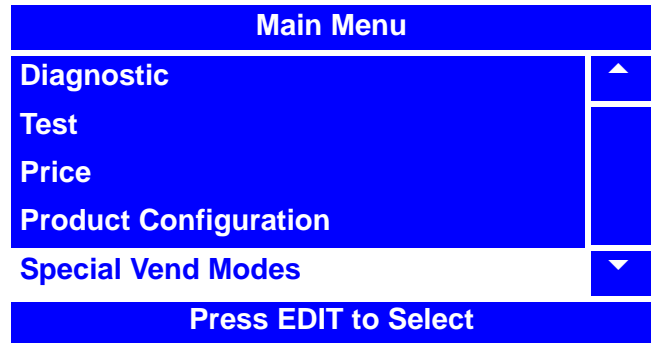

The Merchant™ can be programmed for up to 16 discrete time of day events, which can be programmed to include **Inhibit**, **Free Vend**, **Discount** and **Combo Vend**.

1. Press  until you reach the **Main Menu**, then use  or  to select **Special Vend Modes** and press .



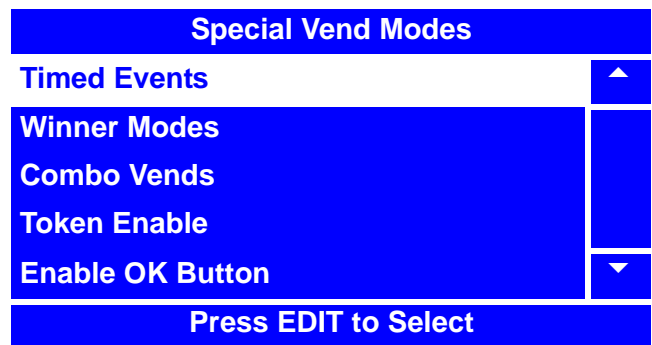



2. From the **Special Vend Modes** menu, use  or  to select **Timed Events** and press .





3. From the **Timed Events** menu, use  or  to select **Time of Day Events** and press .





4. In the **Time of Day Events** menu, use  or  to select **Inhibit** and press .

Time of Day Events			
1	Inhibit	Off	
2	Inhibit	Off	
3	Inhibit	Off	
4	Inhibit	Off	
5	Free Vend	Off	
6	Free Vend	Off	



Timed Events-Time of Day Events (continued)

5. If the event is set to **Off**, use  or  to select **State** and press .

6. In the **State** menu screen, use  or  to select **On**. The selected option is the one with the filled-in circle.

Press  to lock in the selection and return to the **Event (#)** menu. Verify that the status (bottom) line displays **On** when **State** is selected.

7. In the **Event (#)** menu, select **Event Type** and press .

8. In the **Event Type** menu, the selected option is the one with the filled-in circle. Press  or  to change the selected option.

9. Press  to lock in the selection and return to the **Event (#)** menu. Verify that the status (bottom) line displays the choice made in step 8 above when **Event Type** is selected.

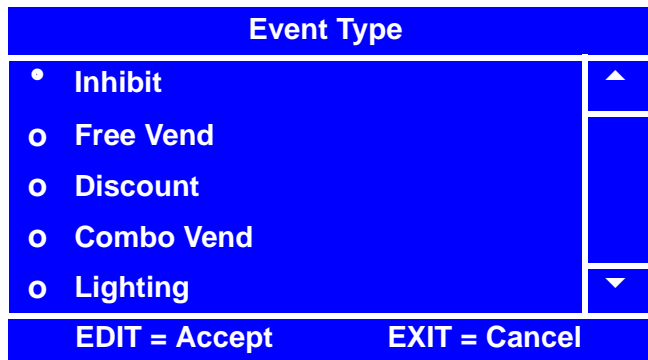
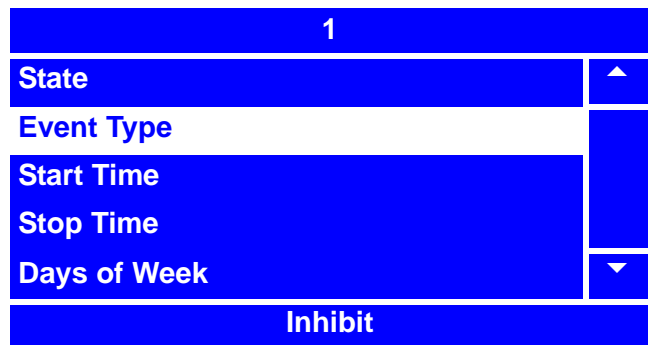
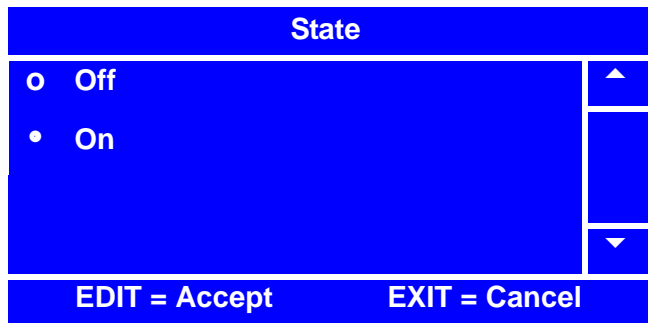
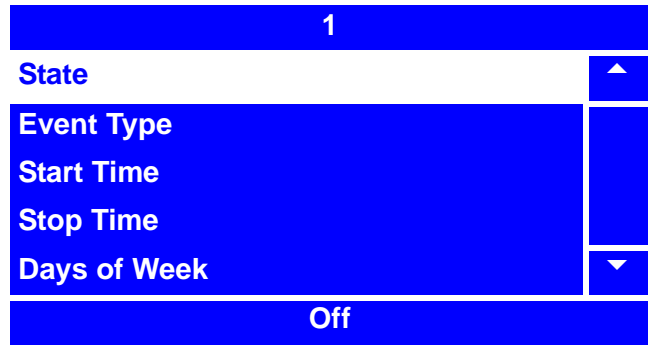

Timed Events-Time of Day Events (continued)

10. In the **Event (#)** menu, use

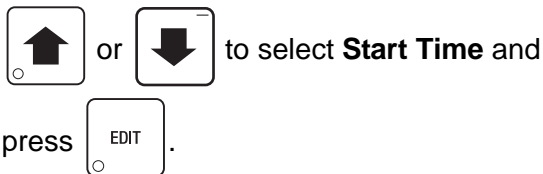

11. In the **Start Time** menu, using the number keys on either keypad, enter the time you wish the event to start. After you have entered four digits, **24** will be selected.

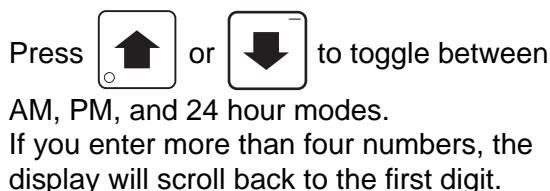

12. Press EDIT to lock in the time and return to the **Event (#)** menu. Verify that the status (bottom) line displays the correct start time when **Start Time** is selected.

13. In the **Event (#)** menu, press

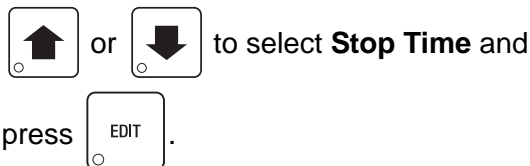

14. In the **Stop Time** menu, using the number keys on either keypad, enter the time you wish the event to stop. After you have entered four digits, the hour mode (AM or PM) will be selected. Press ↑ or ↓ to toggle between AM, PM, and 24 hour modes. If you enter more than four numbers, the display will scroll back to the first digit.

15. Press EDIT to lock in the time and return to the **Event (#)** menu. Verify that the status (bottom) line displays the correct stop time when **Stop Time** is selected.

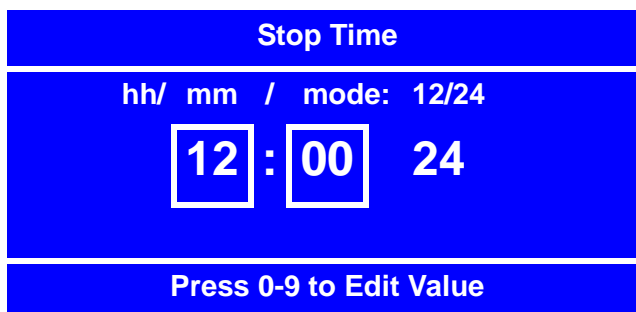
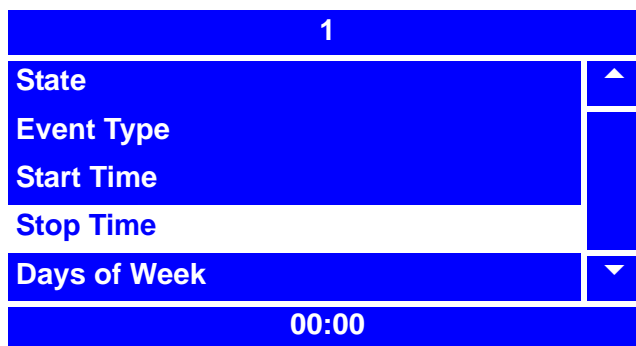
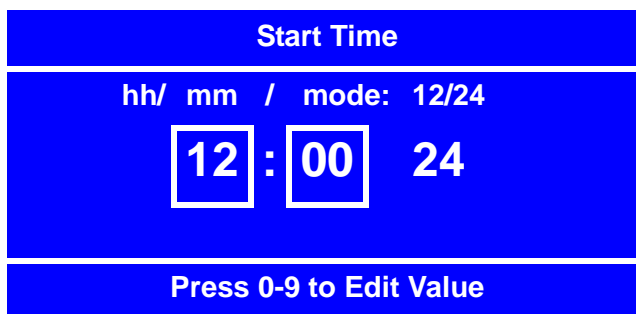
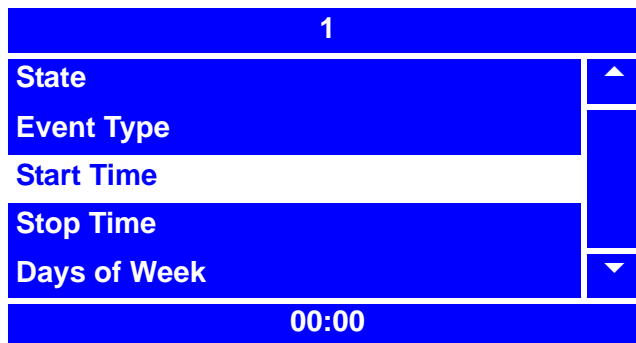

Timed Events-Time of Day Events (continued)

16. In the **Event (#)** menu, press

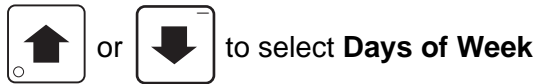

and press .

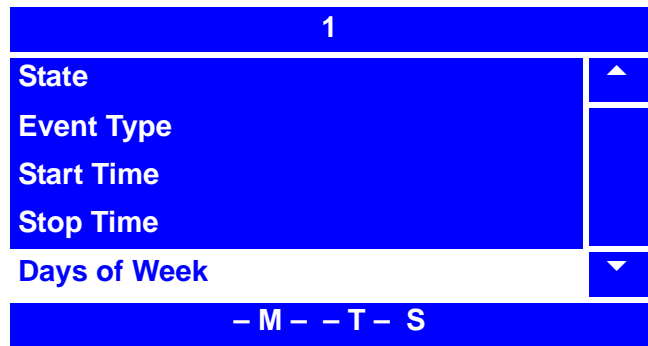

17. Press to highlight a day of

the week, then press to select it. Selected day(s) will have "X"(s) to the left.

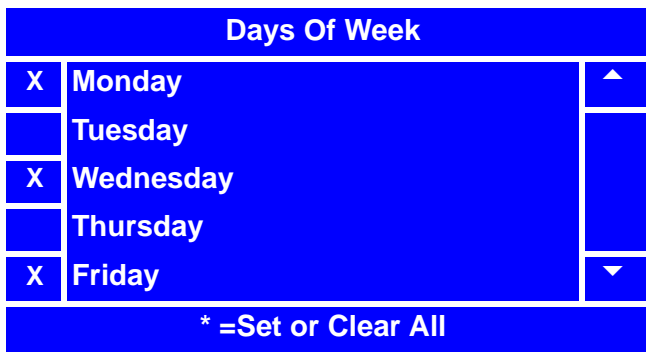

NOTE

By pressing , you are able to quickly remove or add the "X"(s) from all days of the week.

18. Press to lock in the selected days and return to the **Event (#)** menu. Verify that the status (bottom) line displays the correct day(s) of the week that were set.

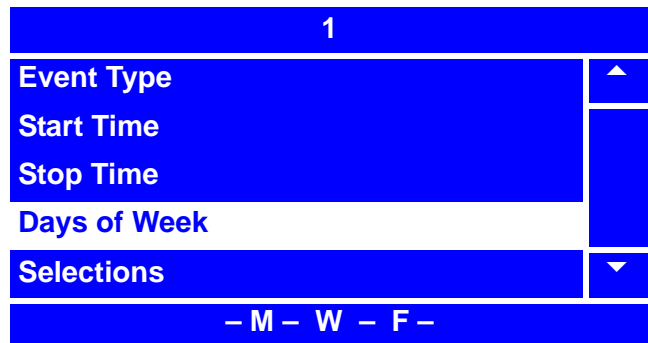

NOTE

Days of the week appear in the status line as dashes, in the order of Sunday through Saturday, if they are not selected.

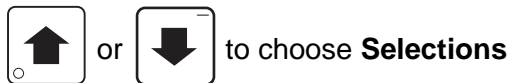

19. In the **Event (#)** menu, press

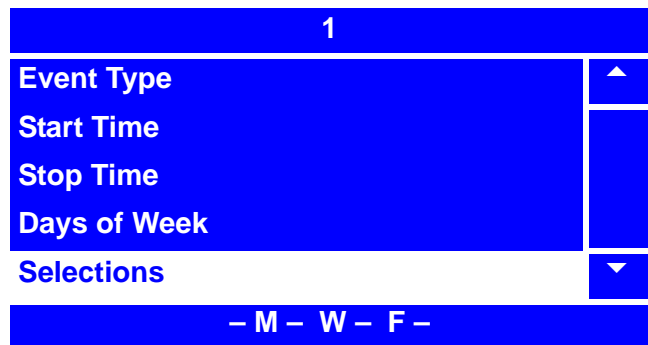

and press .



Timed Events-Time of Day Events (continued)

20. In the **Selections** menu, press  or  to choose a **Selection (XXX)** and press  to select it. Chosen **Selections (XXX)** will have an "X"(s) to the left.





NOTE

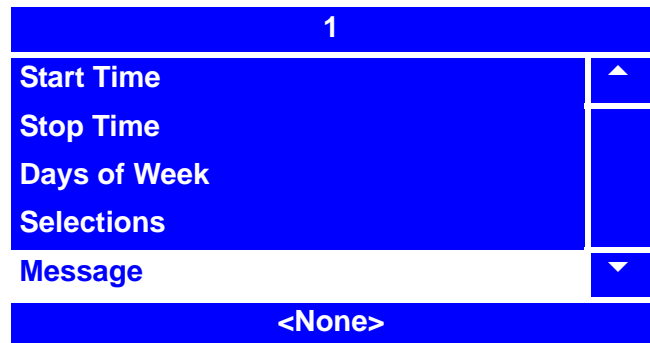

By pressing , you are able to quickly remove or add the "X"(s) from all **Selections**.



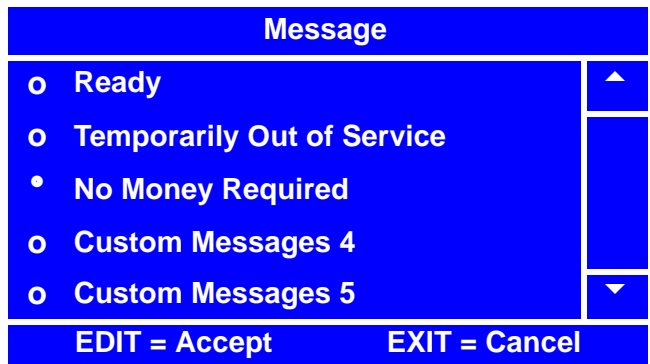

21. Press  to lock in your **Selections** and return to the **Event (#)** menu.



22. In the **Event (#)** menu, press  or  to select **Messages** and press .

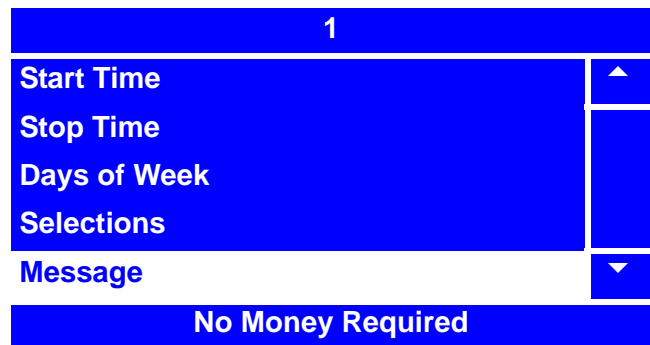

23. In the **Message** menu, the selected option is the one with the filled-in circle. Press  or  to change the selected option.







24. Press  to lock in the selection and return to the **Event (#)** menu. Verify that the status (bottom) line displays the choice made in step 24 above when **Message** is selected.



25. Press  once to return to the **Time of Day Events** menu to set more Events, or continue to press  to return to the **Main Menu**.

Timed Events-Powersave

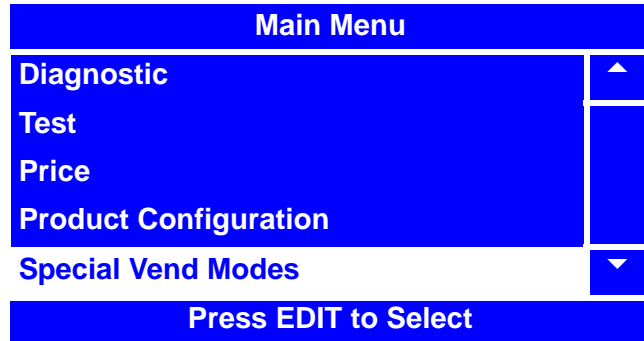

Use the Powersave feature to set up time intervals when the machine can turn off the lights and go into a low power mode.

1. Press  until you reach the **Main Menu**, then use  or  to select **Special Vend Modes** and press .



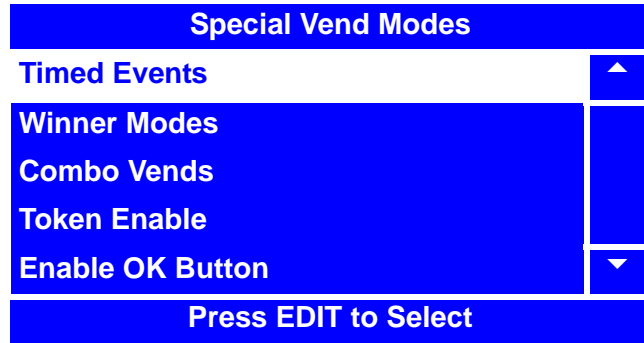



2. From the **Special Vend Modes** menu, use  or  to select **Timed Events** and press .

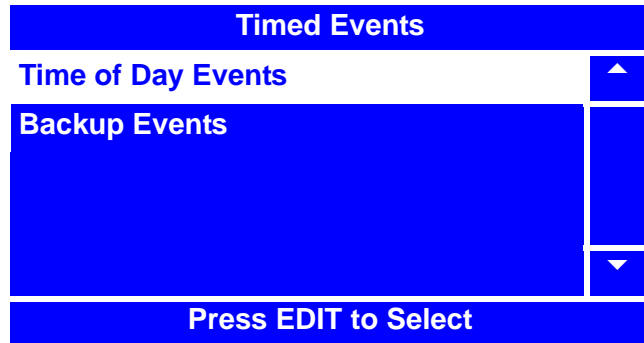

3. From the **Timed Events** menu, use  or  to select **Time of Day Events** and press .



4. In the **Time of Day Events** menu, use  or  to select the **Time of Day** event you want to modify and press .

Time of Day Events			
1	Inhibit	Off	
2	Inhibit	Off	
3	Inhibit	Off	
4	Inhibit	Off	
5	Free Vend	Off	
6	Free Vend	Off	



Note:



In this example we are using event number 1 but any event 1 -16 may be used.

Note:

The names assigned to each timed event 1 - 16 will change as the **Time of Day Events** are modified. In our example the description next to event 1 will say "Lighting" instead of "Inhibit" the next time we view the **Time of Day Events** screen.



Timed Events-Powersave (continued)

5. If the event is set to **Off**, use  or  to select **State** and press .

6. In the **State** menu screen, use  or  to select **On**. The selected option is the one with the filled-in circle.

Press  to lock in the selection and return to the **Event (#)** menu. Verify that the status (bottom) line displays **On** when **State** is selected.

7. In the **Event (#)** menu, select **Event Type** and press .

8. In the **Event Type** menu, the selected option is the one with the filled-in circle. Press  or  to select **Lighting**.

9. Press  to lock in the selection and return to the **Event (#)** menu. Verify that the status (bottom) line displays the choice made in step 8 above when **Event Type** is selected.

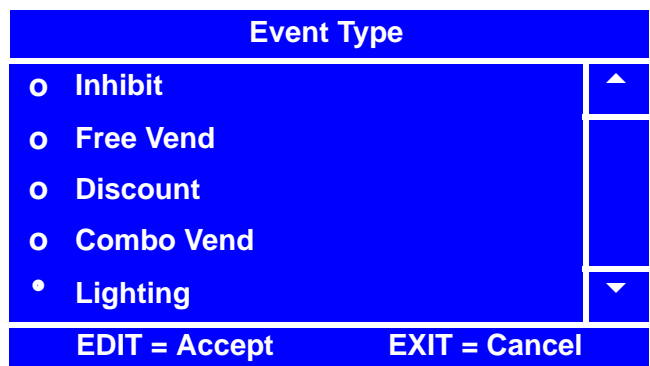
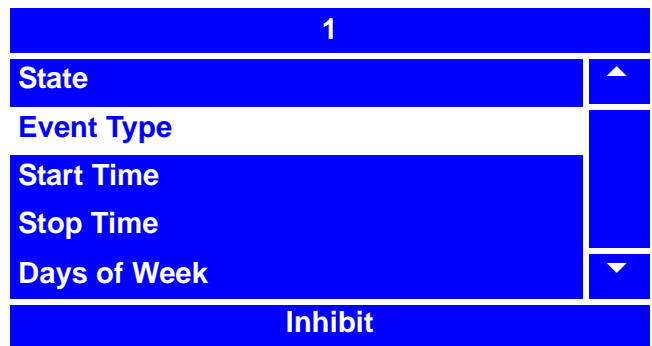
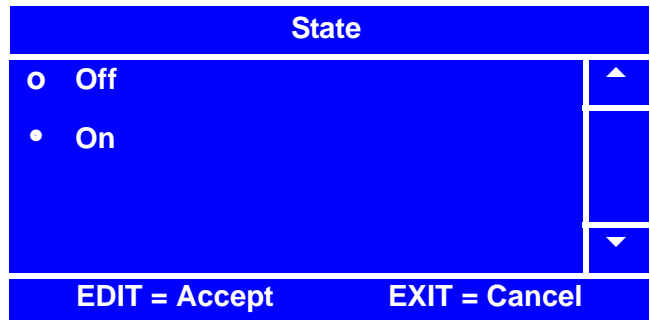
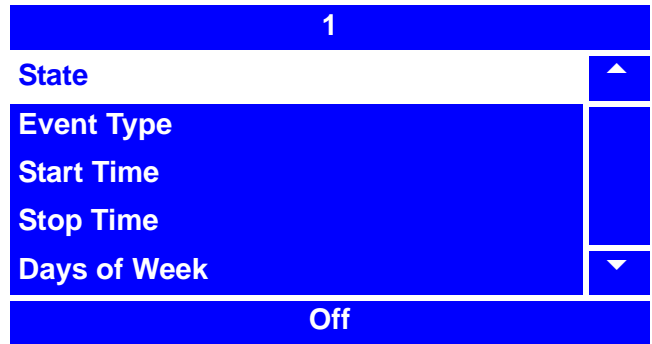

Timed Events-Powersave (continued)

10. In the **Event (#)** menu, use

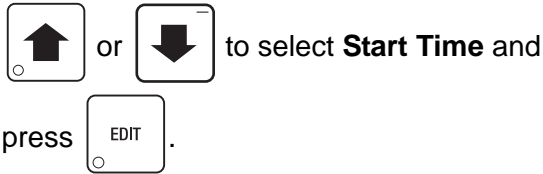

11. In the **Start Time** menu, using the number keys on either keypad, enter the time you wish the event to start. After you have entered four digits, **24** will be selected.

Press or to toggle between AM, PM, and 24 hour modes. If you enter more than four numbers, the display will scroll back to the first digit.

12. Press to lock in the time and return to the **Event (#)** menu. Verify that the status (bottom) line displays the correct start time when **Start Time** is selected.

13. In the **Event (#)** menu, press

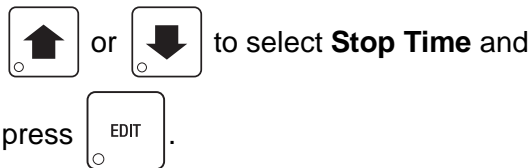

14. In the **Stop Time** menu, using the number keys on either keypad, enter the time you wish the event to stop. After you have entered four digits, the hour mode (AM or PM) will be selected. Press or to toggle between AM, PM, and 24 hour modes. If you enter more than four numbers, the display will scroll back to the first digit.

15. Press to lock in the time and return to the **Event (#)** menu. Verify that the status (bottom) line displays the correct stop time when **Stop Time** is selected

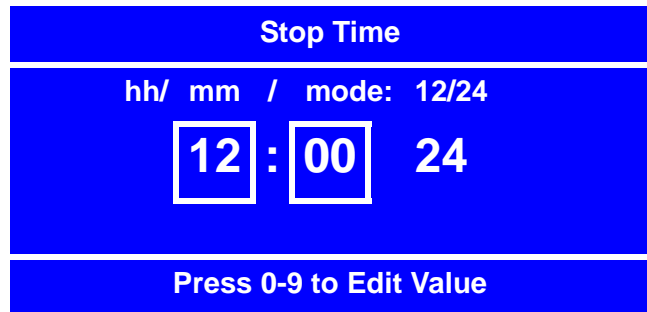
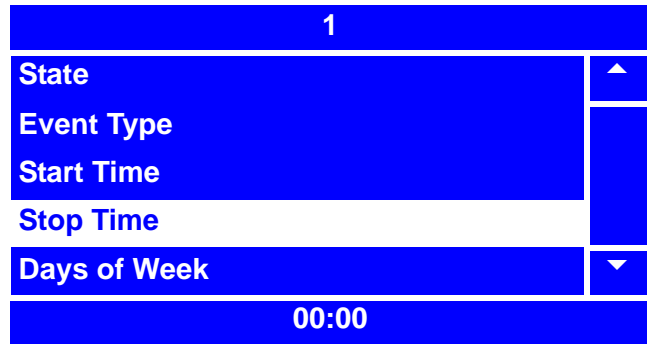
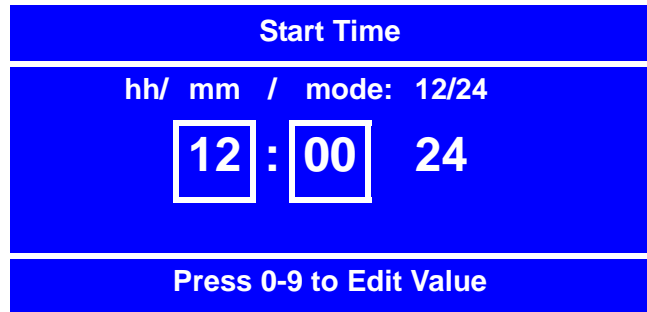
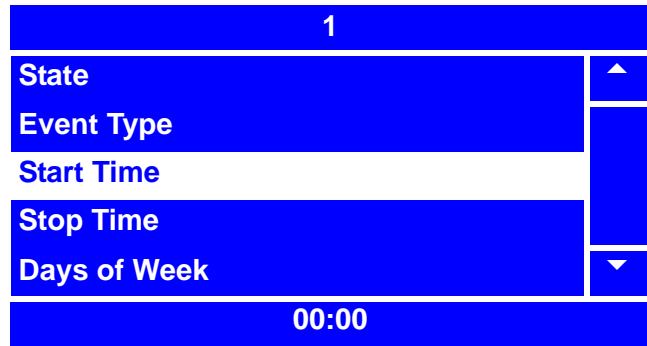

Timed Events-Powersave (continued)

16. In the **Event (#)** menu, press

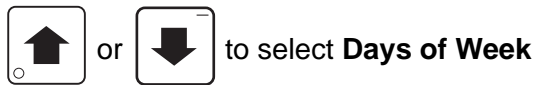

and press .

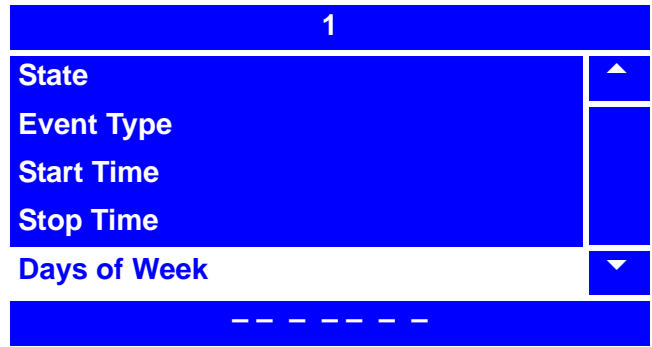

17. Press or to highlight a day

of the week, then press to select it. Selected day(s) will have "X"(s) to the left.

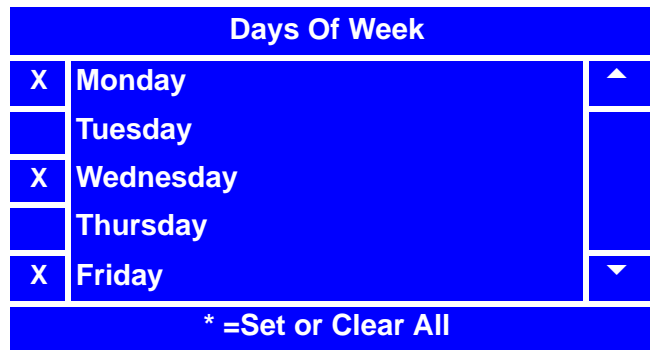

NOTE

By pressing , you are able to quickly remove or add the "X"(s) from all days of the week.

18. Press to lock in the selected days and return to the **Event (#)** menu. Verify that the status (bottom) line displays the correct day(s) of the week that were set.

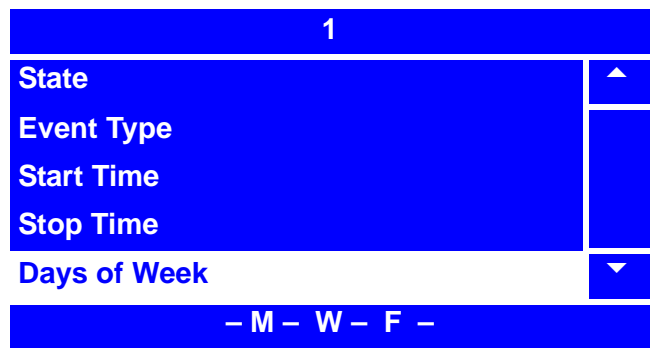

NOTE

Days of the week appear in the status line as dashes, in the order of Sunday through Saturday, if they are not selected.

19. In the **Event (#)** menu, press



Timeout and press .

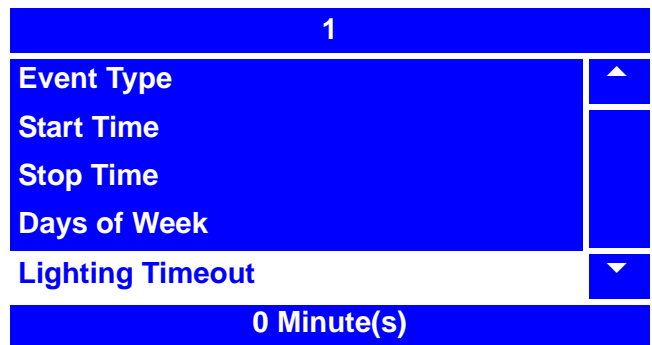

Timed Events-Powersave (continued)

20. Using the number keys on either keypad, enter the setting for the **Lighting Timeout** from 1 to 999 minutes.
If the setting is less than 10, use leading zeros:

For example, if you wish to set the Lighting Timeout to 9 minutes, press 0-0-9
If you enter more than three numbers, the display will scroll back to the first digit.

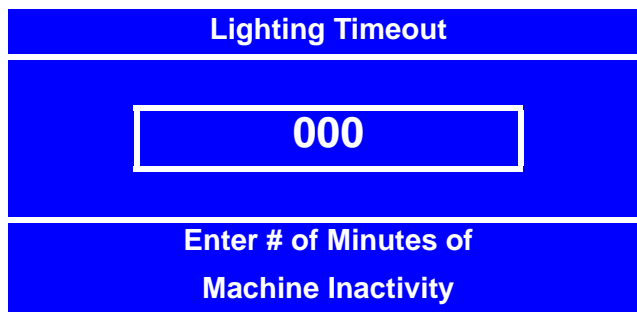



NOTE





The Lighting Timeout setting is the length of time of inactivity that will pass before the lights go off if a customer has turned the lights on **during this timed event**.

21. Press  to lock in the setting and return to the **Event (#)** menu.



22. In the **Event (#)** menu, verify that the value you entered matches the status (bottom) line when **Lighting Timeout** is selected.

23. Press  once to return to the **Time of Day Events** menu, or continue to press  to return to the **Main Menu**.

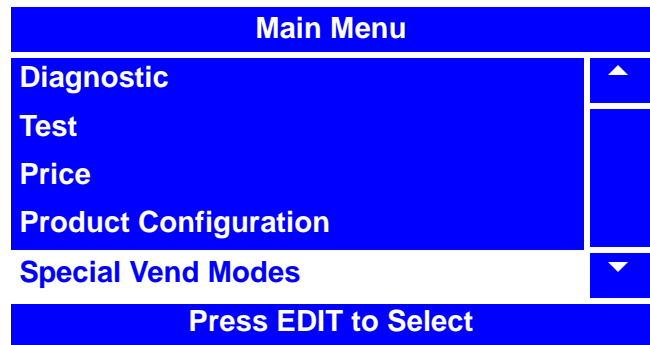

Timed Events - Backup Events

1. Press  until you reach the **Main Menu**, then use  or  to select **Special Vend Modes** and press .



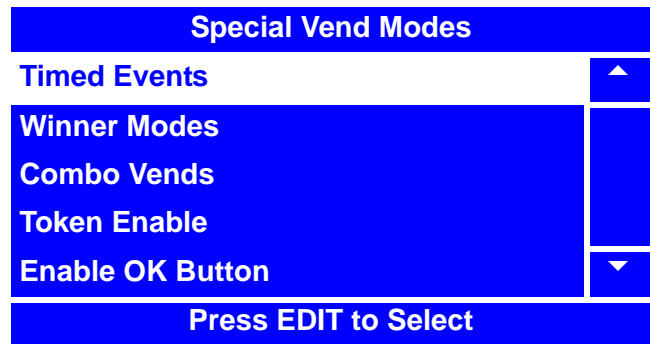

2. From the **Special Vend Modes** menu, use  or  to select **Timed Events** and press .



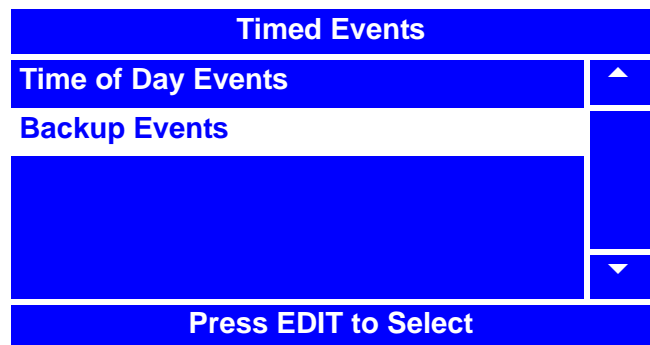

3. From the **Timed Events** menu, use  or  to select **Backup Events** and press .



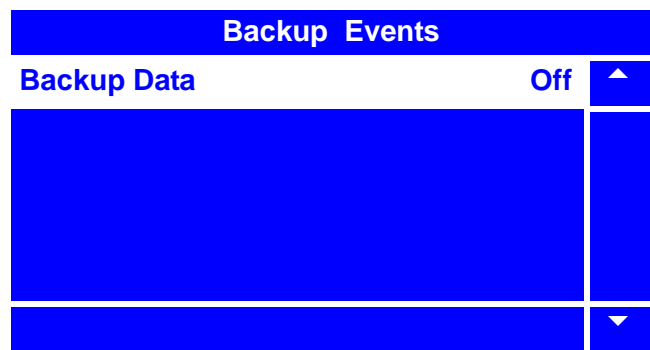

4. In the Backup Events menu, use  or  to select Backup Data and press .



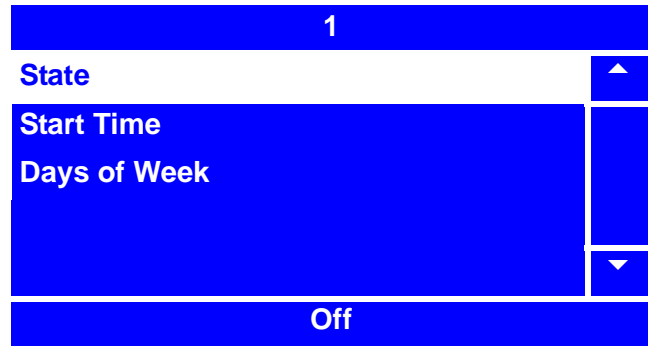

Timed Events - Backup Events (continued)



5. If **Backup Data** is set to **Off**, use  or  to select **State** and press .

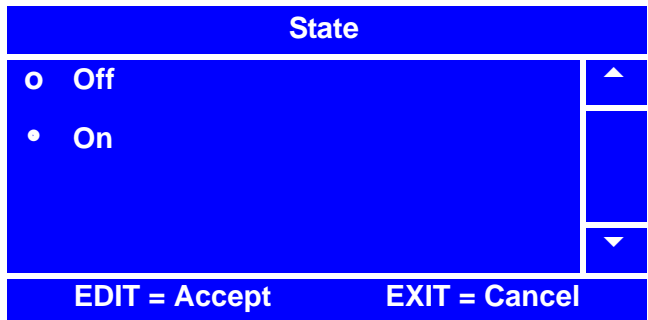

6. In the **State** menu screen, use  or  to select **On**. The selected option is the one with the filled-in circle.



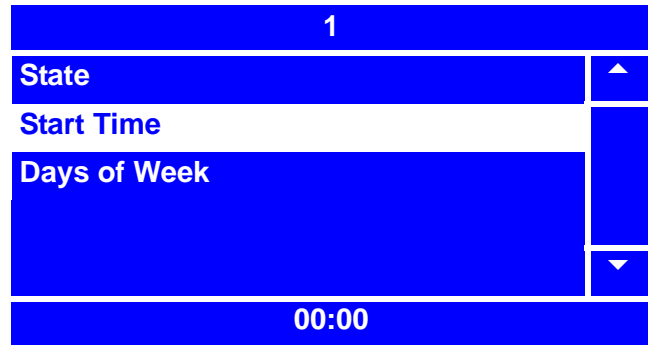

Press  to lock in the selection and return to the **Event (#)** menu. Verify that the status (bottom) line displays **On** when **State** is selected.

10. In the **Event (#)** menu, use  or  to select **Start Time** and press .

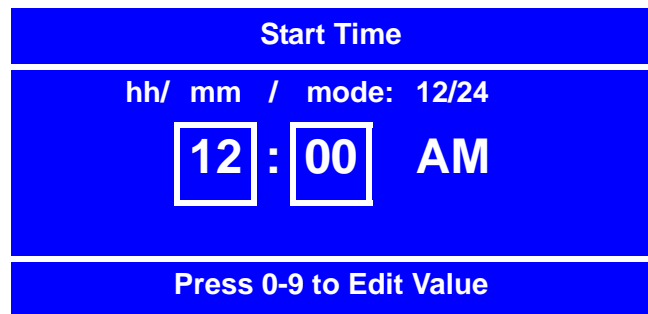

11. In the **Start Time** menu, using the number keys on either keypad, enter the time you wish the event to start. After you have entered four digits, **AM** will be selected.







Press  or  to toggle between AM, PM, and 24 hour modes. If you enter more than four numbers, the display will scroll back to the first digit.

12. Press  to lock in the time and return to the **Event (#)** menu. Verify that the status (bottom) line displays the correct start time when **Start Time** is selected.

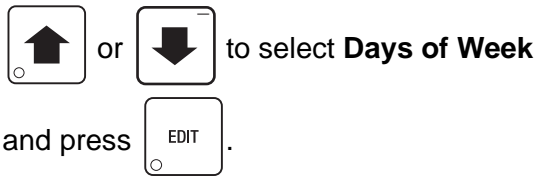
Timed Events - Backup Events (continued)

13. In the **Event (#)** menu, press



14. Press  or  to highlight a day of the week, then press  to select it. Selected day(s) will have "X"(s) to the left.

NOTE

By pressing , you are able to quickly remove or add the "X"(s) from all days of the week.

15. Press  to lock in the selected days and return to the **Event (#)** menu. Verify that the status (bottom) line displays the correct day(s) of the week that were set.

NOTE





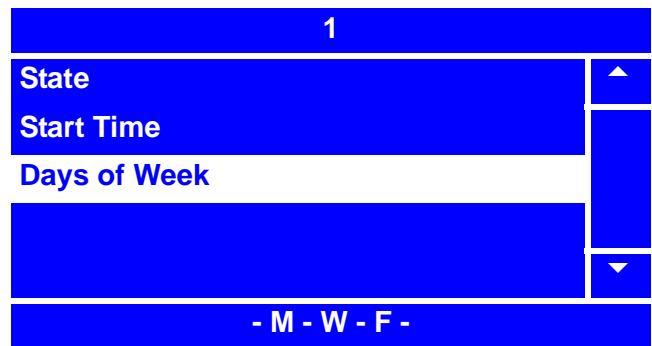
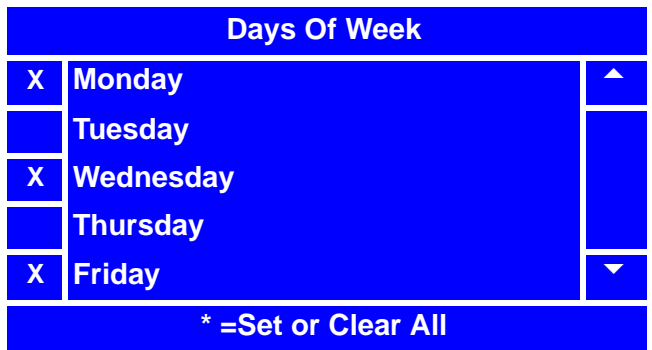
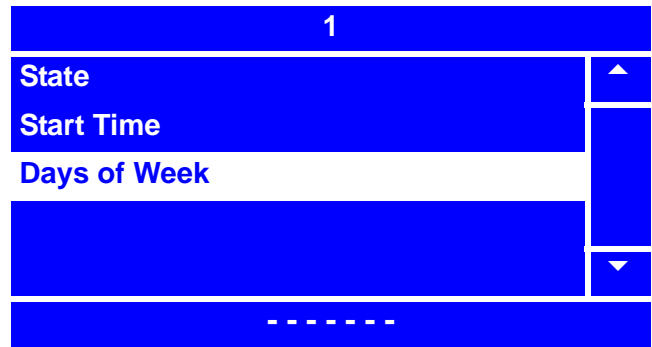







Days of the week appear in the status line as dashes, in the order of Sunday through Saturday, if they are not selected.

16. Press  twice to reach the **Timed Events** menu, three times to reach the **Special Vend Modes** menu, or four times to reach the **Main Menu**.



Winner Mode

The **Winner Mode** provides a method to reward the frequent user of the Merchant™ by occasionally giving away a free product or a special prize from a designated spiral. To set up the **Winner Mode**, perform the following steps:

1. Press  until you reach the **Main Menu**, then use the  or  to select **Special Vend Modes** and press .
2. From the **Special Vend Modes** menu, use  or  to select **Winner Mode** and press .
3. From the **Winner Mode** menu, use  or  to select **Winner State**. The status (bottom) line will then indicate if the **Winner Mode** is currently turned **On** or **Off**.
4. To change the **Winner Mode** state, press  with **Winner State** selected.
5. In the **Winner State** menu, use  or  to select **On** or **Off**. The selected option is the one with the filled-in circle.
6. Press  to lock in the selection and return to the **Winner Mode** menu. Verify that the status (bottom) line displays **On** or **Off** when **Winner State** is selected.

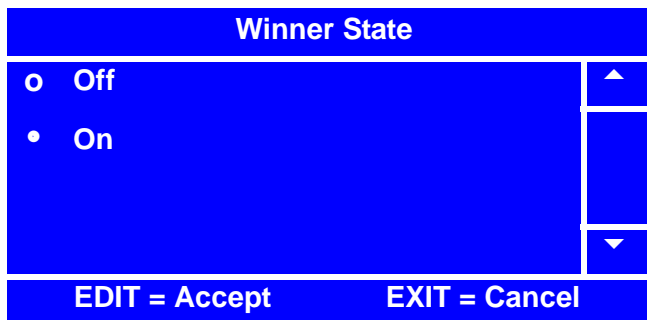
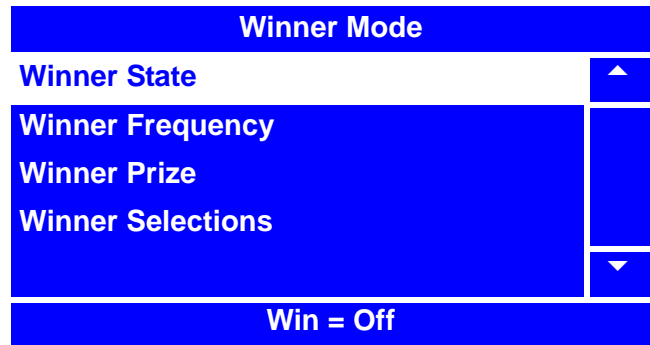
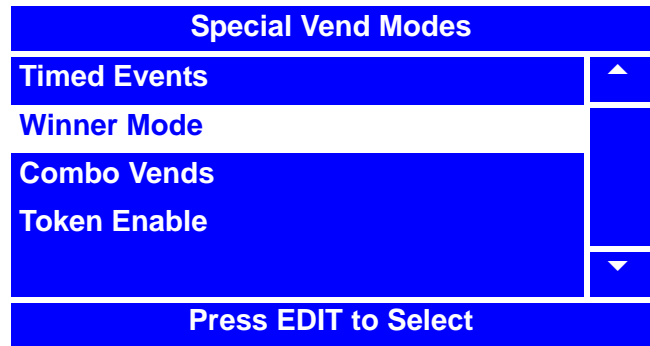
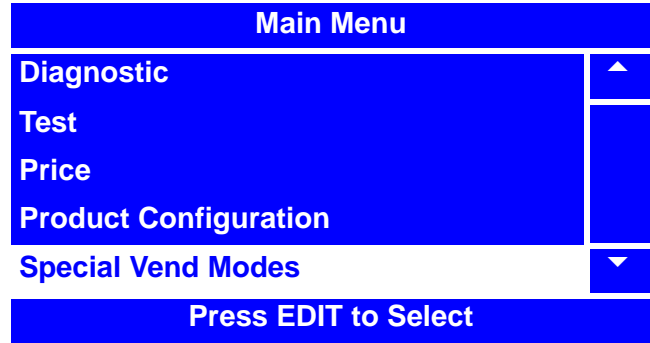

Winner Mode (continued)

7. From the **Winner Mode** menu, use

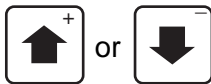

to select **Winner**

Frequency. The status (bottom) line of the will display how often the merchandiser is set to vend a winner.

8. To change the winner frequency, press



with **Winner Frequency** selected.

9. Using the number keys on either keypad, enter an interval for the **Winner Frequency**. If the frequency of a winning vend is less than 1,000, use leading zeros:

For example, if you wish to set the merchandiser to vend a winner every 500 vends, press 0-5-0-0.

If you enter more than four numbers, the display will scroll back to the first digit.

10. Press



to lock in the selection and

return to the **Winner Mode** menu. Verify that the status (bottom) line displays the number of vends that the **Winner Frequency** has been set for.

11. From the **Winner Mode** menu, use

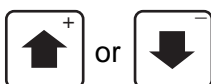

to select **Winner Prize**.

The status (bottom) line of the **Winner Mode** menu will then indicate which spiral the winner will vend from. If the status line of the menu states **Prize Mode OFF**, then a **Winner Prize** spiral has not yet been chosen.

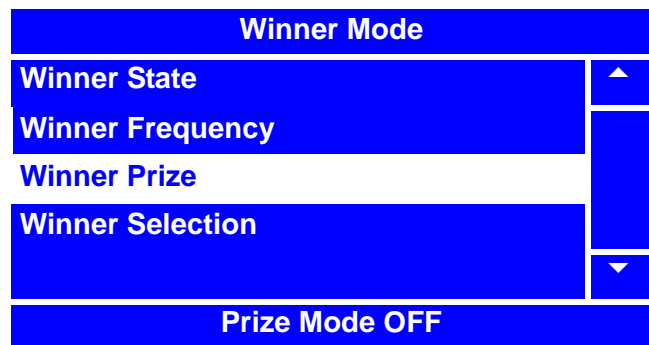
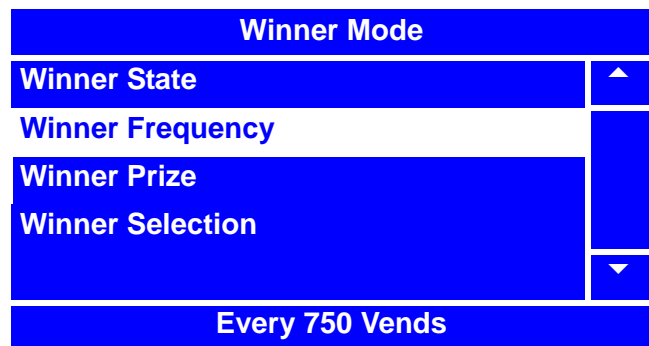
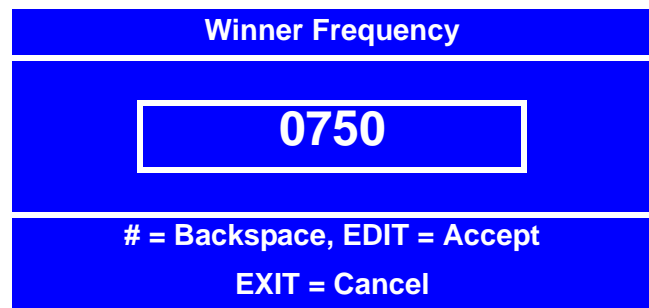
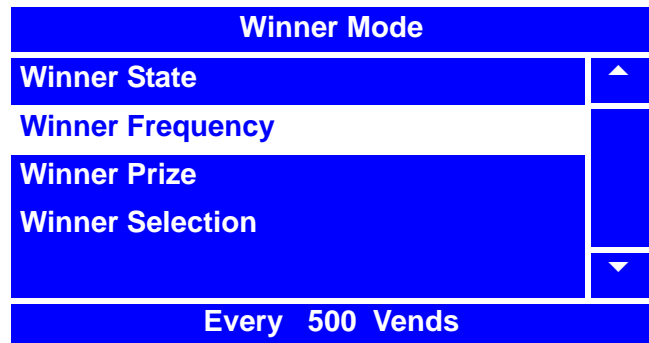

NOTE

The status (bottom) line will display **INVALID** if the selection is not valid or if the selection is part of a FIFO group or is the coupled spiral of a coupled selection.

12. To set or change the **Winner Prize** spiral, press



with **Winner Prize** selected.

Winner Mode (continued)

13. Using the number keys on either keypad, enter a spiral for the winner to vend from. For example, to set the merchandiser to vend the winners from spiral 103, enter 1-0-3. If you enter more than three numbers, the display will scroll back to the first digit.



14. Press  to lock in the selection and return to the **Winner Mode** menu. Verify that the status (bottom) line displays the spiral that the **Winner Prize** is set to vend from.

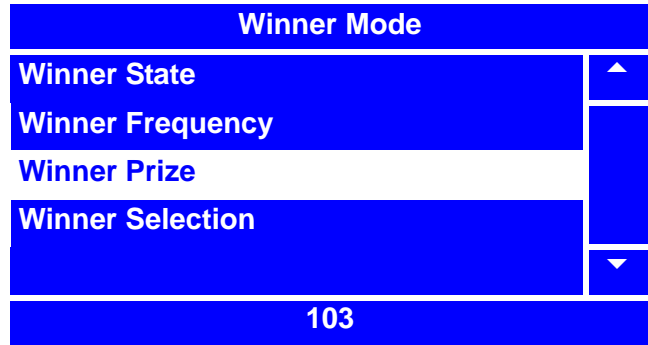

15. From the **Winner Mode** menu, use





Winner Selection.

NOTE

Winner Selections are the Selections that will trigger a **Winner Prize** vend.

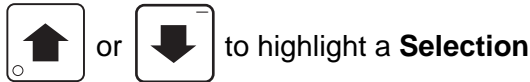
16. In the **Winner Selections** menu, press



(**XXX**), and press  to select it. Chosen **Winner Selection(s)** (**XXX**) will have "**X**"(s) to the left.

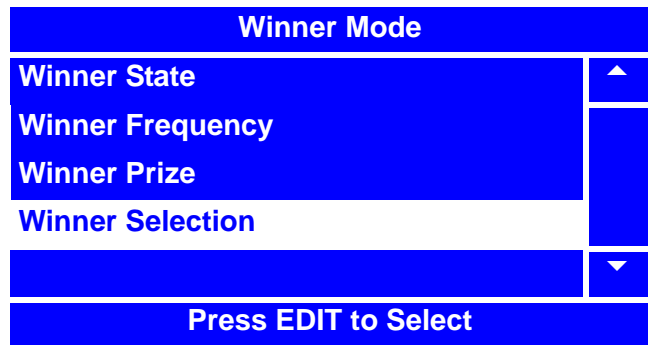

NOTE

By pressing , you are able to quickly remove or add the "**X**"(s) from all **Winner Selections**.

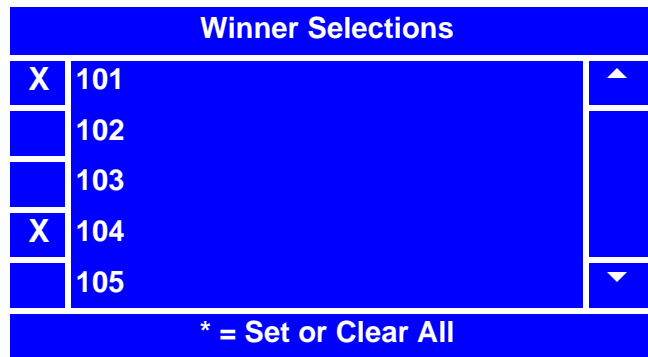





17. Press  to lock in your **Winner Selection(s)** and return to the **Winner Mode** menu.



18. Press  once to return to the **Special Vend Modes** menu or twice to return to the **Main Menu**.

Combo Vends

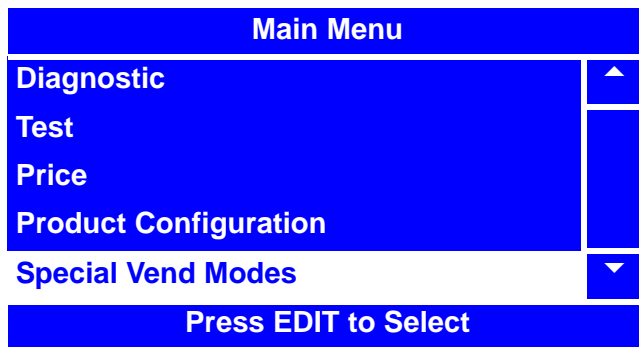

The Merchant™ can be programmed to support up to four combination groups of products to be vended together at a discounted price. **Combo Vends require a Time-Of-Day Event to vend.** Combo Groups are associated with Combo Event Time-Of-Day events. Products selected in the Time-Of-Day event (see Timed Events, step 20 on page 113) are “Combo Items” with those products in the assigned Combo Group. To program your Merchant™ to vend combination vends, perform the following procedure.

1. Press  until you reach the **Main Menu**, then use  or  to select **Special Vend Modes** and press .



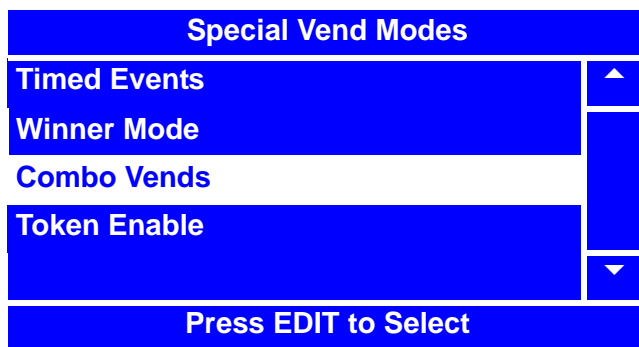

2. From the **Special Vend Modes** menu, use  or  to select **Combo Vends** and press .

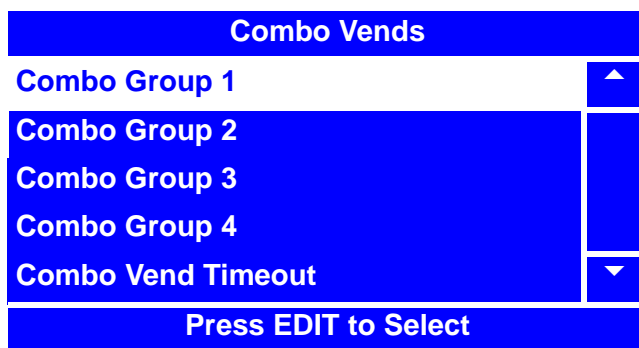

3. From the **Combo Vends** menu, use  or  to select which **Combo Group** you want to program, and then press .



4. From the **Combo Group X** menu, use  or  to choose **Selections** and press .

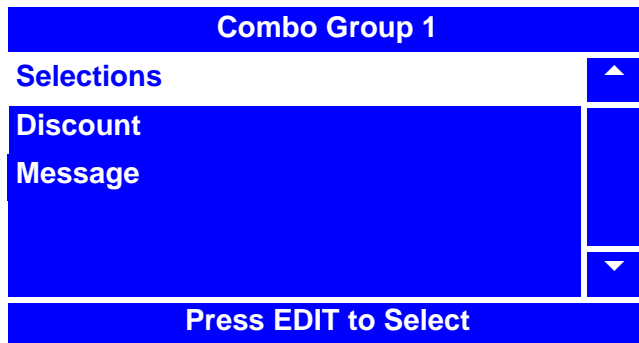

Combo Vends (continued)

5. In the **Selections** menu, use

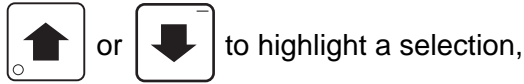

and press to select it. Chosen selection(s) will have "X" (s) to the left.

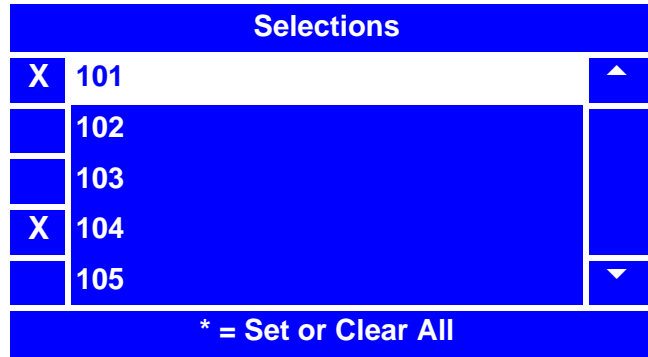

NOTE

By pressing , you are able to quickly remove or add the "X" (s) from all of the selection(s).

6. Press to lock in the selection and return to the **Combo Group X** menu.

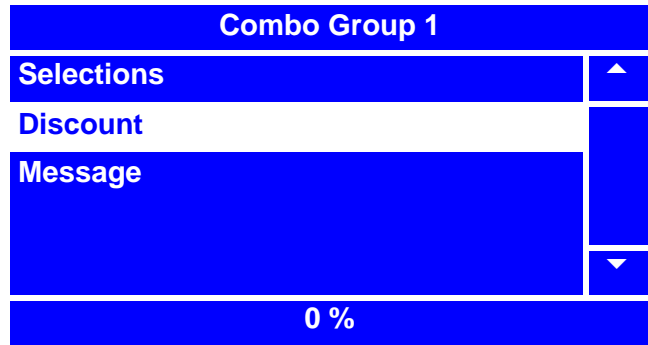

7. From the **Combo Group X** menu, use

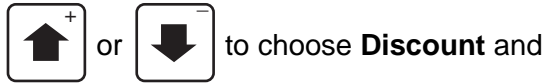

press .

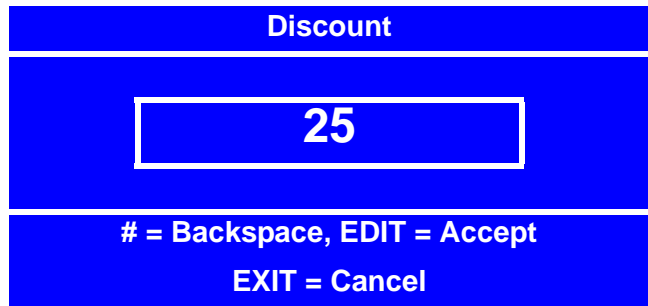

8. Using the number keys on either keypad, enter a percentage of discount for **Combo Group X**. If the percentage of discount is less than 10%, use leading zeros:

For example, if you wish to set the merchandiser to discount a Combo Vend Group 5%, press 0-5.

If you enter more than two numbers, the display will scroll back to the first digit.

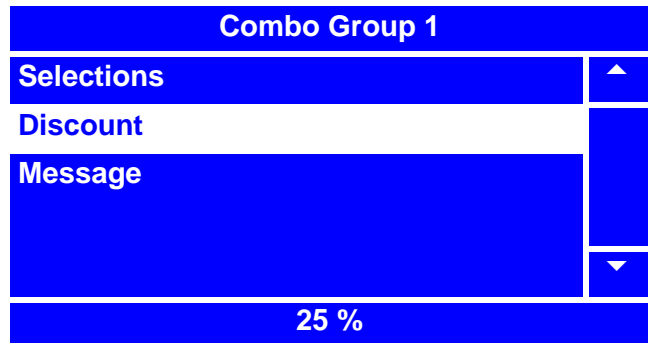

9. Press to lock in the selection and return to the **Combo Group X** menu. Verify that the status (bottom) line displays the percentage of discount for **Combo Group X**.

Combo Vends (continued)

10. From the **Combo Group X** menu, use



11. From the **Message** menu, use

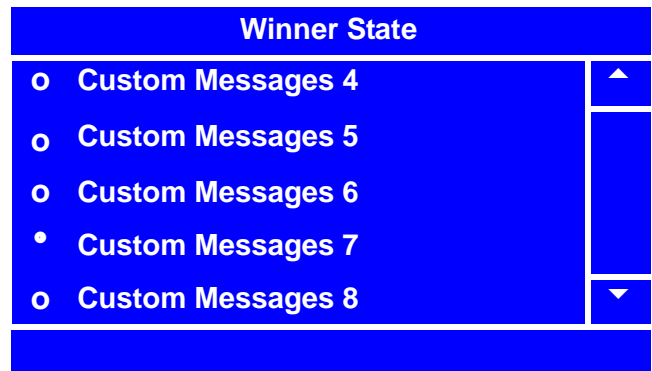
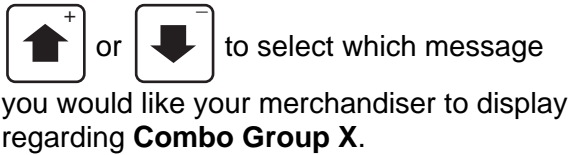

NOTE

For an explanation of **Custom Messages** that can be chosen or programed to display for the **Combo Group** you are setting up, please refer to "Set Custom Messages" on page 188.



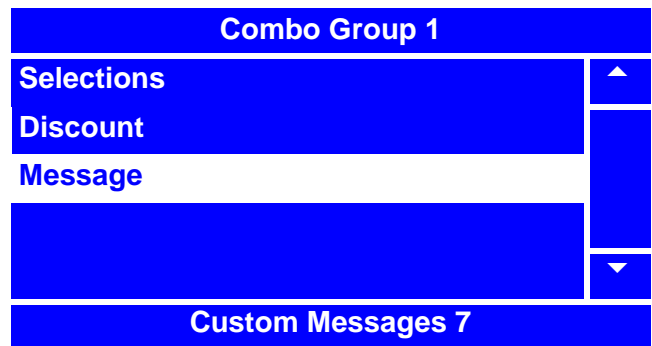

12. Press **EDIT** to lock in the selection and return to the **Combo Group X** menu. Verify that the status (bottom) line displays the percentage of discount for **Combo Group X**.







13. Press **EDIT** once to return to the **Combo Vends** menu, twice to return to the **Special Vend Modes** menu or three times to return to the **Main Menu**.

Token Enable

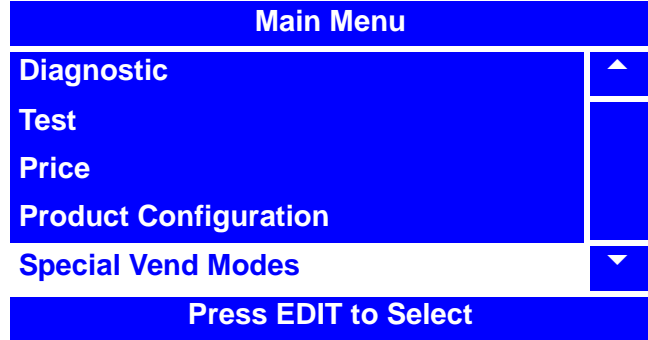

The Merchant™ allows you to program token vending for certain products. To program the Merchant™ for token vending, perform the following procedure.

1. Press  until you reach the **Main Menu**, then use  or , to select **Special Vend Modes** and press .

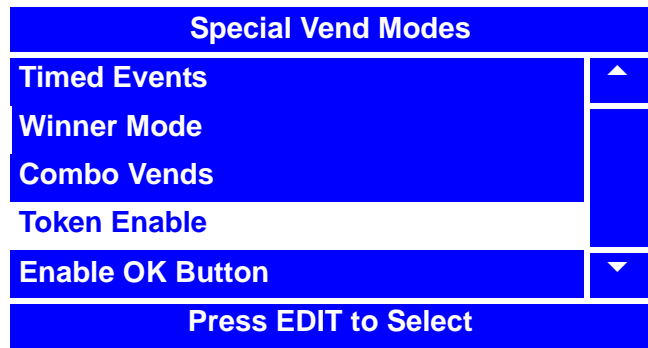

2. From the **Special Vend Modes** menu, use  or  to select **Token Enable** and press .



3. In the **Token Enable** menu, press  or  to highlight a selection, and press  to select it. Chosen selections will have “X”(s) to the left.

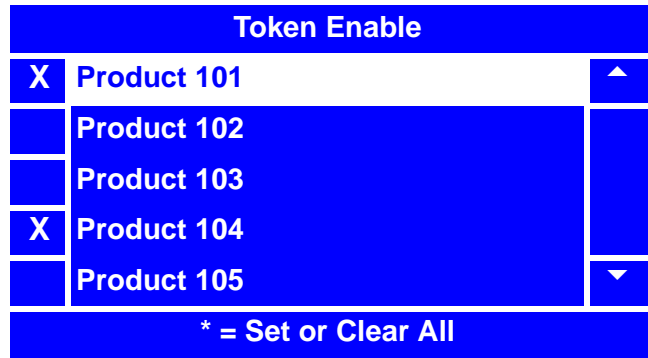

NOTE





By pressing , you are able to quickly remove or add the “X”(s) from all of the selections.

4. Press  once to return to the **Special Vend Modes** menu or twice to return to the **Main Menu**.



NOTE

Token acceptance must be enabled in the **Monetary** menu for token and coupon acceptance to function properly. See ““Set Token/Coupon Acceptance” on page 147

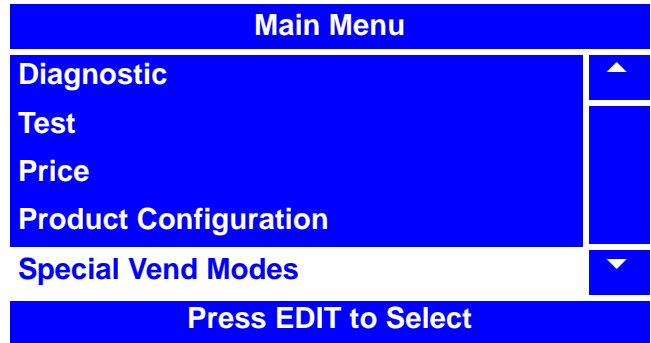

Enable OK Button

1. Press  until you reach the **Main Menu**, then use  or , to select **Special Vend Modes** and press .





2. From the **Special Vend Modes** menu, use  or  to select **Enable OK Button** and press .

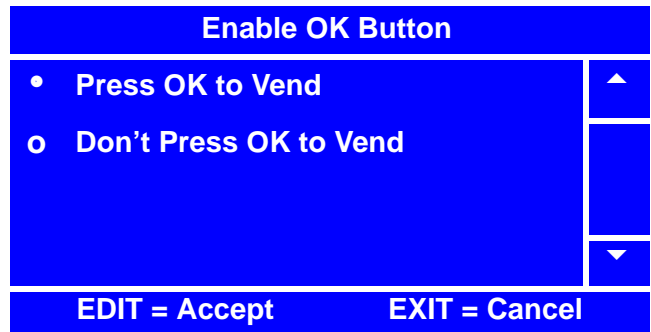

3. In the **Enable OK Button** menu, use  or  to select **Press OK to Vend** or **Don't Press OK to Vend**. The selected option is the one with the filled-in circle.





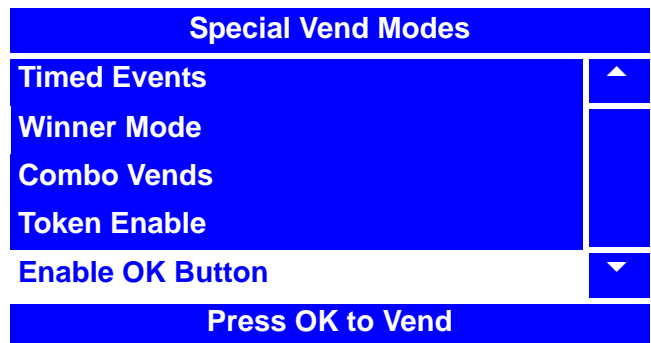

4. Press  to lock in your selection and return to the **Special Vend Modes** menu. Verify that the selected option appears in the status (bottom) line of the menu.

5. Press  to return to the **Main Menu**.





Programming: Free Vend

Turn Free Vend On/Off

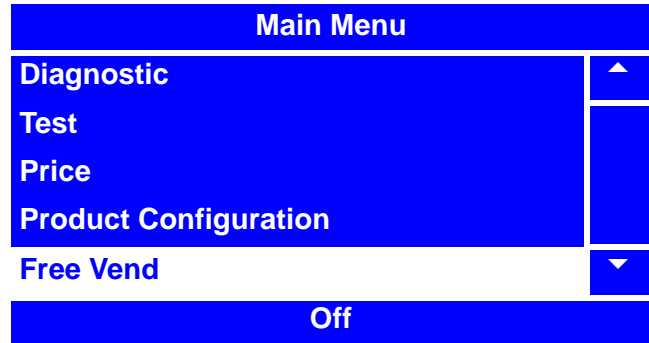
1. Press  until you reach the **Main Menu**, then use  or  to select **Free Vend** and press .



2. In the **Free Vend** menu, press  or  to select **Off** or **On**. The selected option is the one with the filled-in circle.

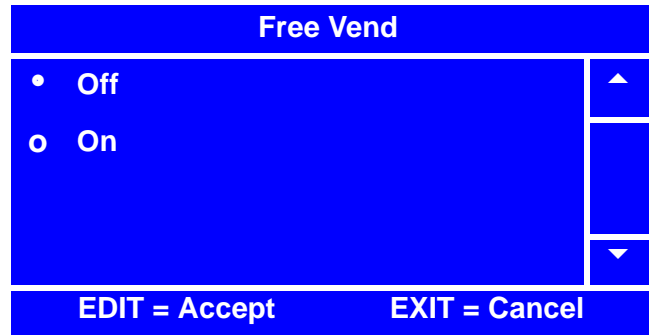















3. Press  to lock in your selection (**Off** or **On**) and return to the **Main Menu**. Verify that the status (bottom) line displays the correct option when **Free Vend** is selected.

NOTE

When **Free Vend** is **On**, the standby message will display “**No Money Required**”, alternating with “**Make a Selection**”.

Programming: System Settings

Machine Information - ID Number

- Press  until you reach the **Main Menu**, then use  or  to select **System Settings** and press .
- In the **System Settings** menu, use  or  to select **Machine Information** and press .
- In the **Machine Information** menu, use the  or  to select **Machine ID** (in this example, it is "ID106-Asset Number") and press .
- The **Machine ID** screen will allow you to use the keypad to enter an alternate Machine ID. Using the  and  will move the cursor to the left and right. Press  to remove the letters and numbers. Press  to move to uppercase letters and lowercase. Press 0-9 to add a letter or number. Press the number once to bring up the character screen (lower bottom). Press the number again to scroll to the character. Refer to the "NUMERIC/CHARACTER TABLE" on page 191. In this case, we have entered "**Merchandiser 407.**"

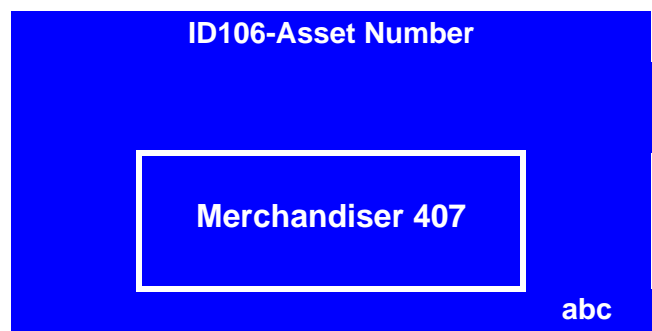
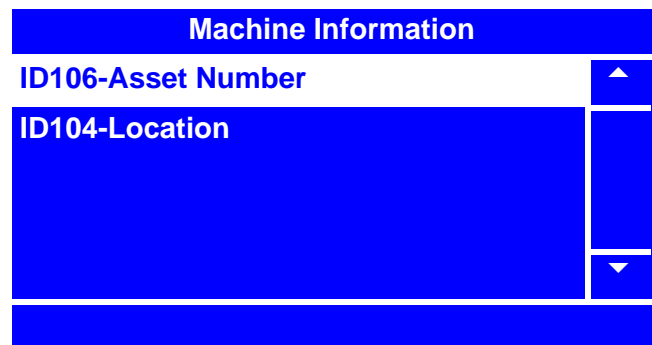
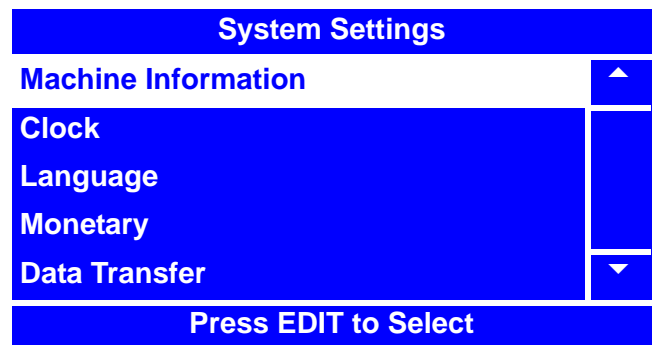
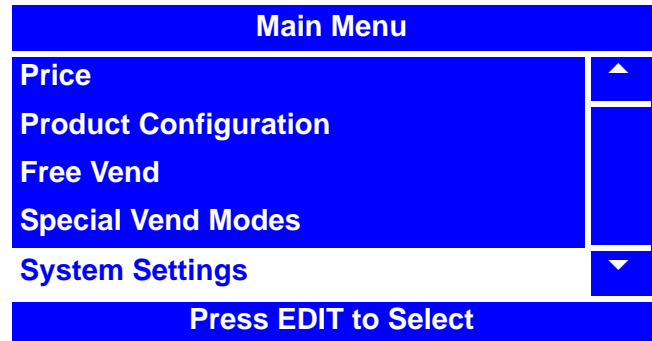







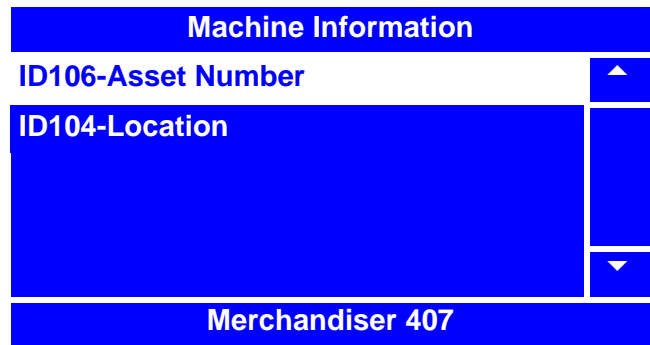







Machine Information - ID Number (continued)

5. Press  to lock in your entered information and return to the **Machine Information** menu. Verify that the new information you have entered appears in the status (bottom) line.

6. Press  once to return to the **System Settings** menu or twice to return to the **Main Menu**.



Machine Information - Location

1. Press  until you reach the **Main Menu**, then use  or  to select **System Settings** and press .
2. In the **System Settings** menu, use  or  to select **Machine Information** and press .
3. In the **Machine Information** menu, use  or  to select **Machine Location** (in this example it is "ID106-Asset Number") and press .
4. The **Machine ID** screen will allow you to use the keypad to enter an alternate Machine ID. Using the  and  will move the cursor to the left and right.
 Press  to remove the letters and numbers.
 Press  to move to uppercase letters and lowercase. Press 0-9 to add a letter or number. Press the number once to bring up the character screen (lower bottom). Press the number again to scroll to the character. Refer to the "NUMERIC/ CHARACTER TABLE" on page 191. In this case, we have entered "**St. Louis - 27.**"

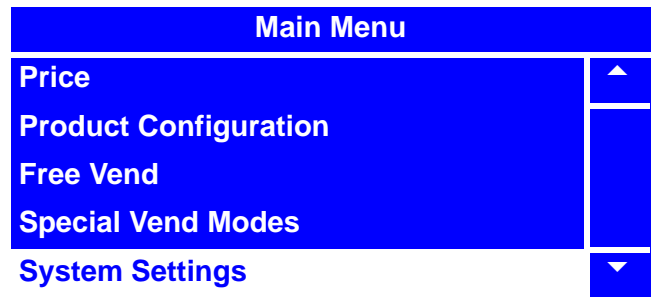

Press EDIT to Select

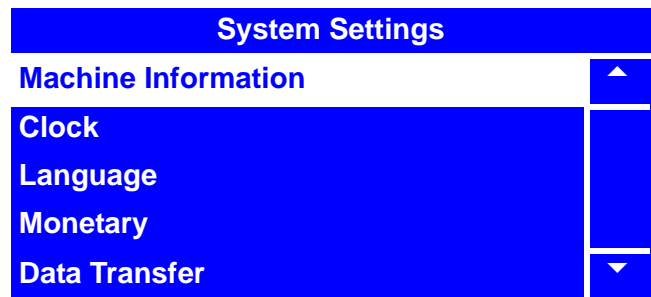

Press EDIT to Select

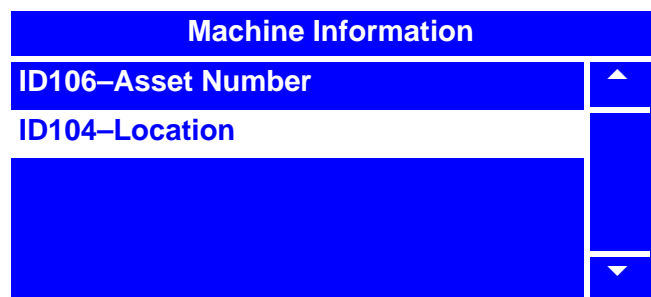

Press EDIT to Select

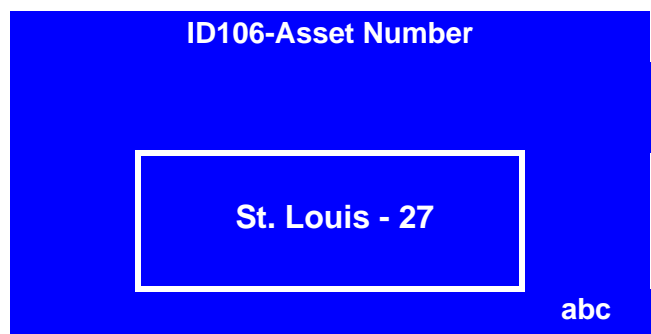







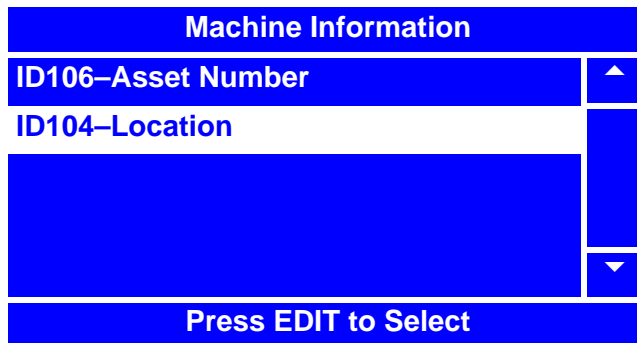



Machine Information - Location (continued)

5. Press  to lock in your entered information and return to the **Machine Information** menu. Verify that the new information you have entered appears in the status (bottom) line.

6. Press  once to return to the **System Settings** menu or twice to return to the **Main Menu**.







Set the Date

- Press  until you reach the **Main Menu**, then use  or  to select **System Settings** and press .
- In the **System Settings** menu, use  or  to select **Clock** and press .
- In the **Clock** menu, use  or  to select **Date** and press .
- Using the number keys on either keypad, enter the correct date. Press  to toggle between MM/DD/YY and DD-MM-YY formats.

NOTE







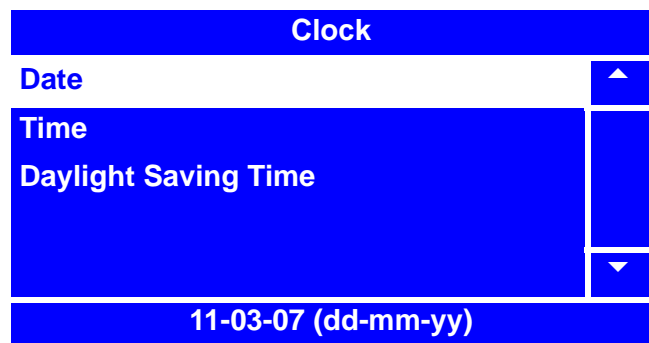
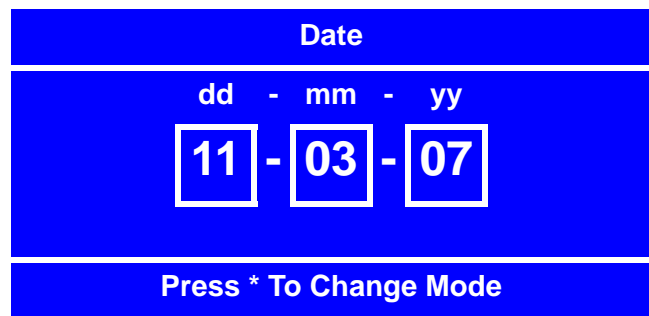
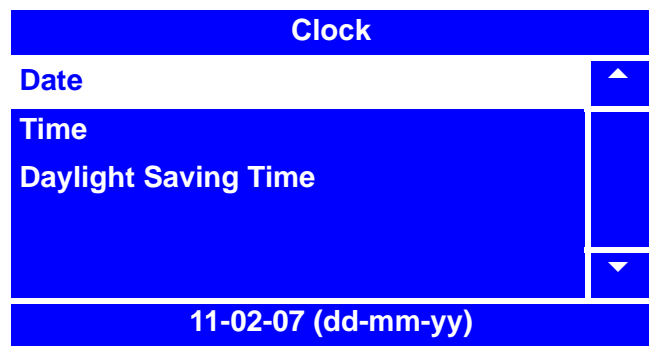
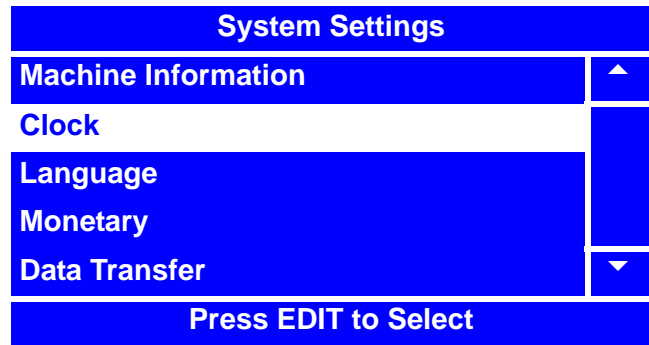
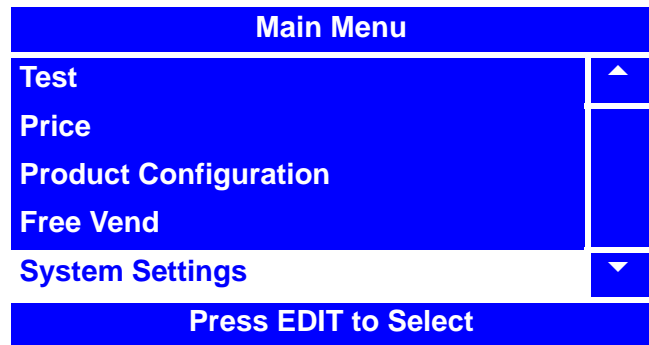



After you enter the last digit of the year, the cursor will return to the first digit. This is helpful if you enter the wrong date.

Using  or  will allow you to move the cursor to the position you desire.

- Press  to lock in the date and return to the **Clock** menu. With **Date** selected, verify that the status (bottom) line displays the date you entered, in the format you selected.
- Press  once to return to the **System Settings** menu or twice to return to the **Main Menu**.







Set the Time

- Press  until you reach the **Main Menu**, then use  or  to select **System Settings** and press .
- In the **System Settings** menu, use  or  to select **Clock** and press .
- In the **Clock** menu, use  or  to select **Time** and press .
- Using the number keys on either keypad, enter the correct time. Press  to toggle between AM, PM and 24-hr. formats.

NOTE





After you enter the last digit of the time, the cursor will return to the first digit. This is helpful if you enter the wrong time.

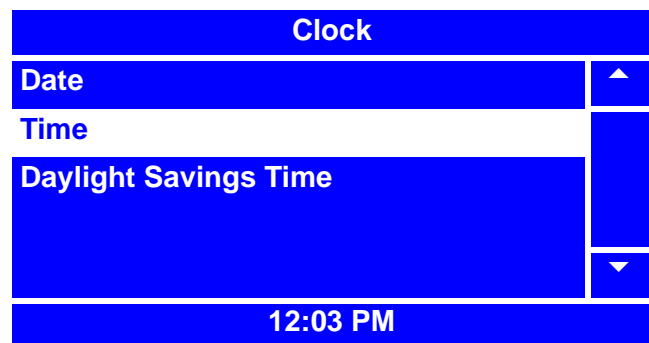
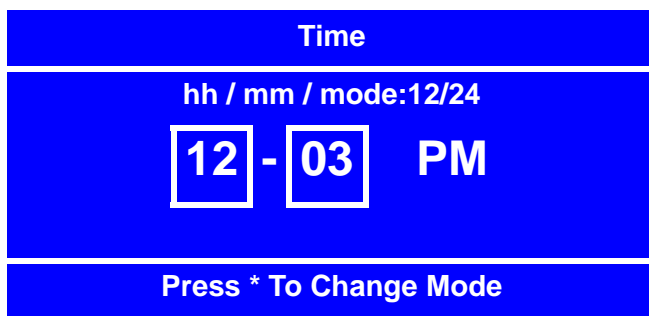
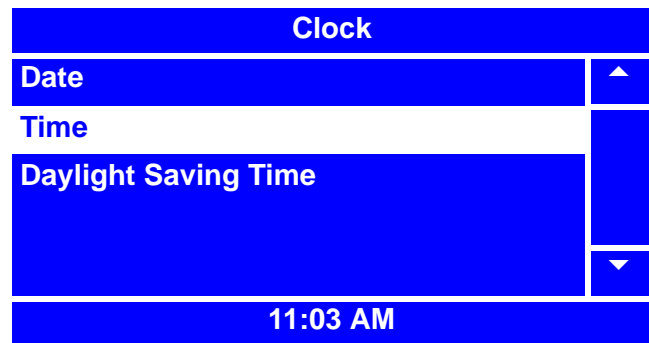
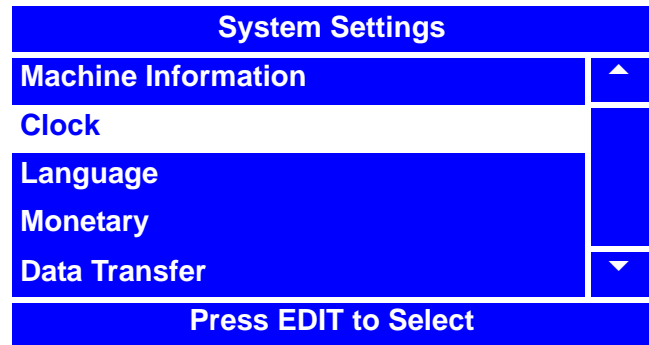
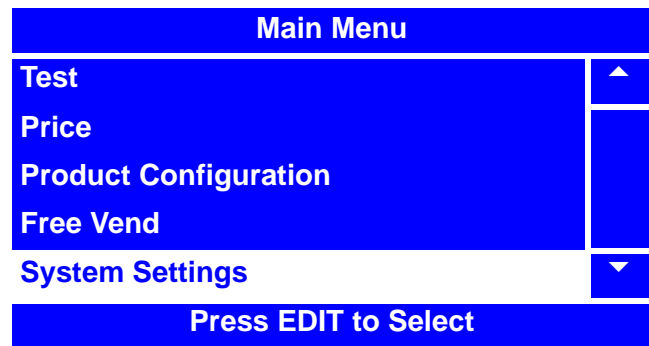

Using  or  will allow you to move the cursor to the position you desire, and change the hour modes.



- Press  to lock in the time and return to the **Clock** menu. With **Time** selected, verify that the status (bottom) line displays the date you entered, in the format you selected.
- Press  once to return to the **System Settings** menu or twice to return to the **Main Menu**.





Set Daylight Saving Time

1. Press  until you reach the **Main Menu**, then use  or  to select **System Settings** and press .

2. In the **System Settings** menu, use  or  to select **Clock** and press .

3. In the **Clock** menu, use  or  to select **Daylight Saving Time** and press .



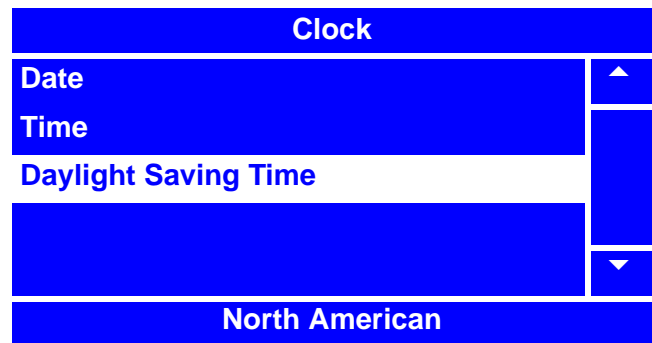
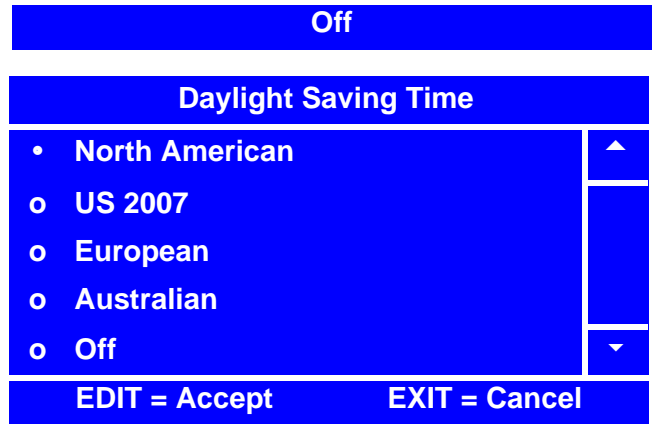
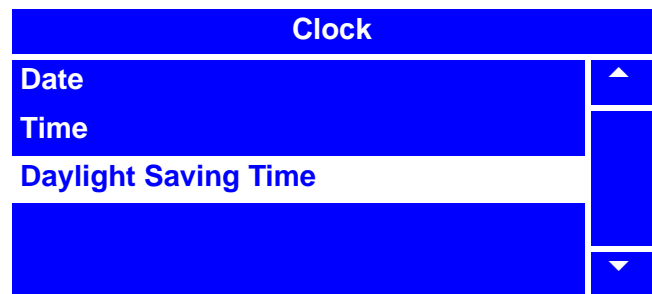
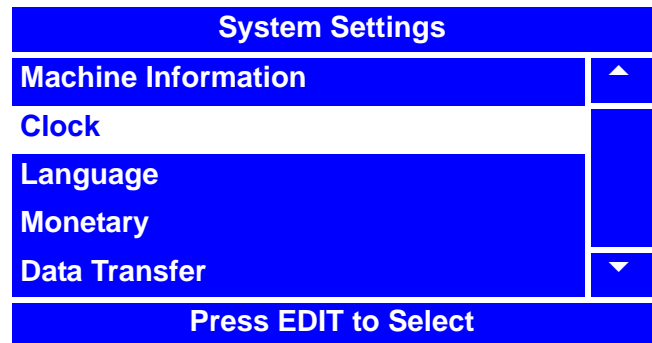
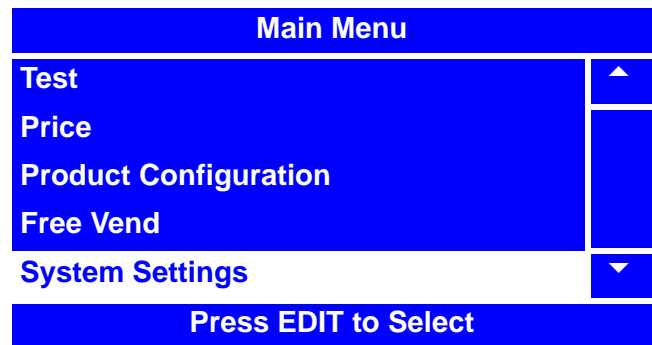

4. In the **Daylight Saving Time** menu, press  or  to select which daylight saving time option you desire. The selected option is the one with the filled-in circle.

5. Press  to lock in the selection and return to the **Clock** menu. With **Daylight Saving Time** selected, verify that the status (bottom) line displays the daylight saving time option you selected.



6. Press  once to return to the **System Settings** menu or twice to return to the **Main Menu**.



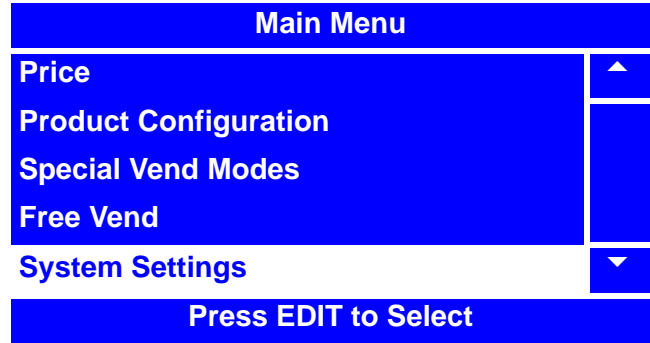

Select a Language

1. Press  until you reach the **Main Menu**, then use  or  to select **System Settings** and press .

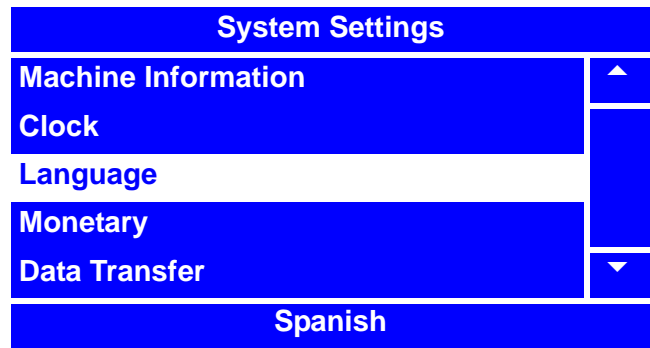

2. In the **System Settings** menu, use  or  to select **Language** and press .



3. In the **Language** menu, press  or  to select the desired language option. The selected option is the one with the filled-in circle.

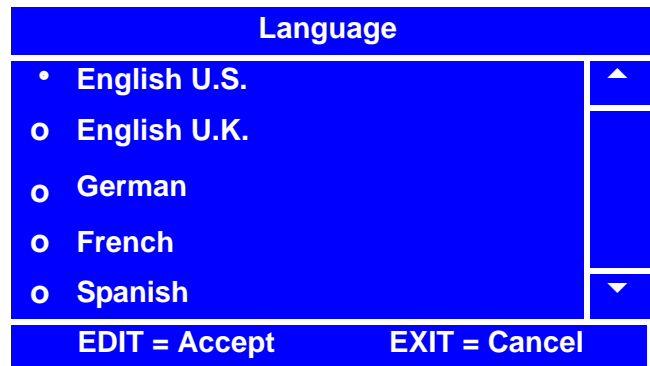





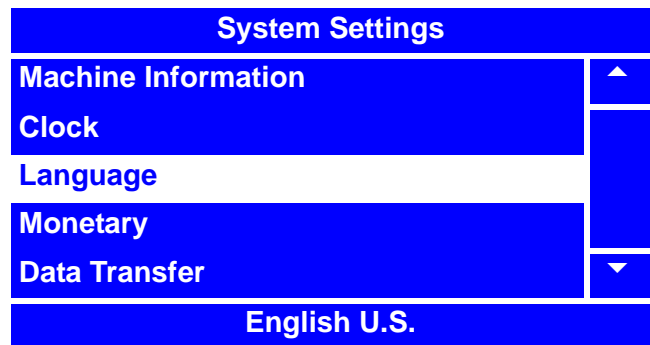

4. Press  to lock in the selection and return to the **System Settings** menu. Verify that the status (bottom) line of the menu displays the selected option.

5. Press  once to return to the **Main Menu**.





Select the Coin Mechanism



1. Press  until you reach the **Main Menu**, then use  or  to select **System Settings** and press .

2. In the **System Settings** menu, use  or  to select **Monetary** and press .

NOTE

The selections in the **Monetary** menu may vary, depending upon how the selections for **Coin Mechanism**, **Bill Validator** and **Card Reader** are set. You will always be able to access **Coin Mechanism**.

3. In the **Monetary** menu, use  or  to select **Coin Mechanism** and press .

4. In the **Coin Mechanism** menu, press  or  to select the desired Coin Mechanism option. The selected option is the one with the filled-in circle.

5. Press  to lock in the selection and return to the **Monetary** menu. With **Coin Mechanism** selected, verify that the status (bottom) line of the **Monetary** menu displays your Coin Mechanism option selection.

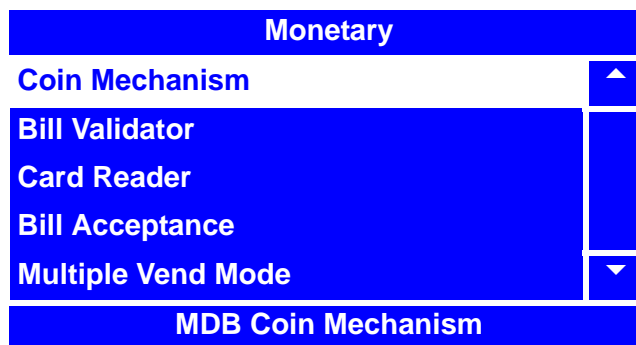
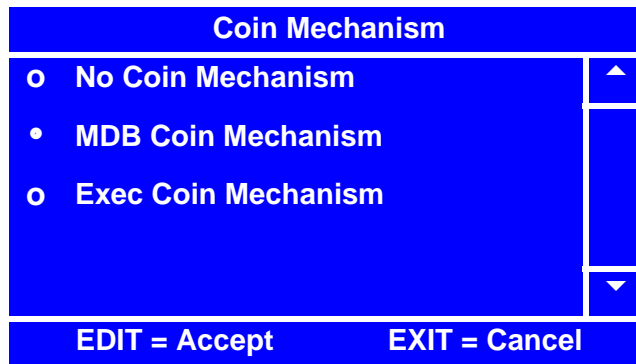
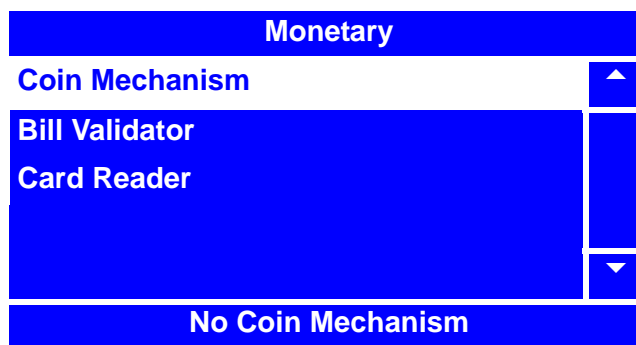
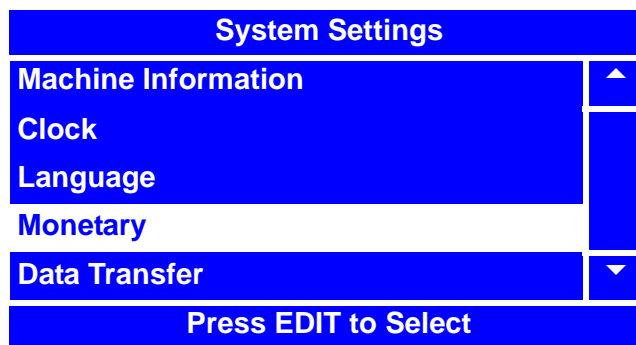
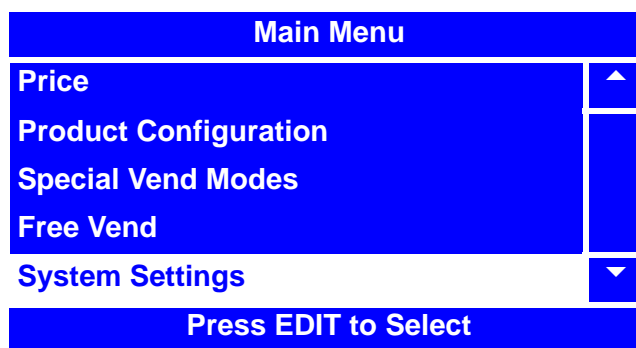

6. Press  once to return to the **System Settings** menu, or twice to return to the **Main Menu**.



View Coins In/Out

NOTE

The **Coins In/Out** menu selection is accessed from the **Main Menu**, and is only available when a **Coin Mechanism** is activated. See "Select the Coin Mechanism" on page 139.

1. Press  until you reach the **Main Menu**, then use  or  to select **Coins In/Out**.

The **Coins In/Out** menu displays the following information:

- The value of the coins that your merchandiser is set to accept.
- The count of each value of coin currently in the merchandiser.
- The total dollar amount of each type of coin that is currently inside your merchandiser.

You can also dispense excess or desired

2. Press the number that corresponds with the coin value you wish to dispense. For example, pressing "3" would dispense one quarter. Each time you press the number, the merchandiser will dispense one of the corresponding value coin.
3. When you are finished viewing the information and/or dispensing excess or desired coins, press  once to return to the **Main Menu**.



NOTE

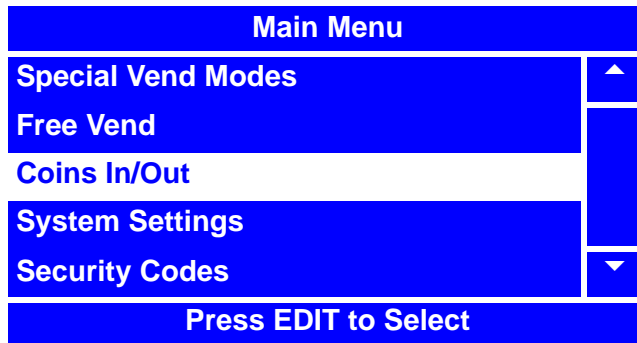

If your merchandiser has a recycler installed, the recycler contents will be reported as part of the count and value totals.



Coins In/Out			
Press	Coins	Count	Value
1	.05	100	5.00
2	.10	215	21.50
3	.25	220	55.00
4	1.00	15	15.00



Set Change Without Purchase

1. Press  until you reach the **Main Menu**, then use  or  to select **System Settings**.

2. In the **System Settings** menu, use  or  to select **Monetary** and press .

NOTE

The **Change Without Purchase** menu selection is only available when a **Coin Mechanism** is activated. See "Select the Coin Mechanism" on page 139.

3. In the **Monetary** menu, use  or  to select **Change Without Purchase** and press .



4. Using the number keys on either keypad, enter the highest denomination of coin or bill that can be changed without purchase. The arrow keys will reposition the cursor.
For example, if 0.00 is set, no change will be returned without purchase. If 00.25 is set, change will be returned is nickels, dimes and/or quarters are inserted. If 01.00 is set, \$1.00 bills and coins will be changed without purchase. Nickels, dimes and quarters are also returned.

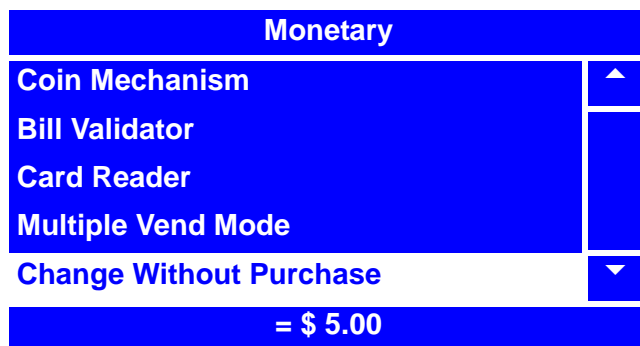
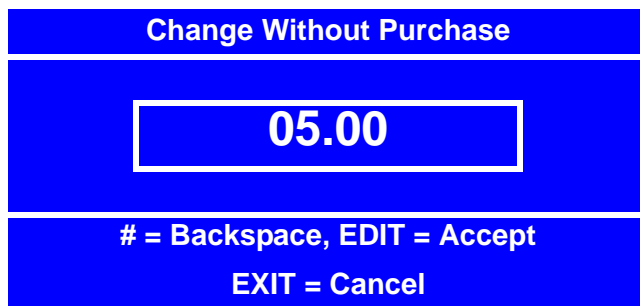
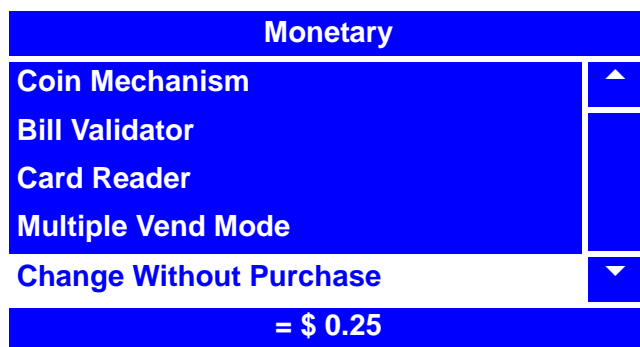
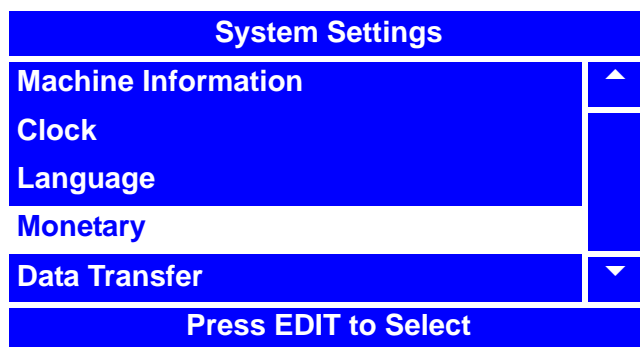
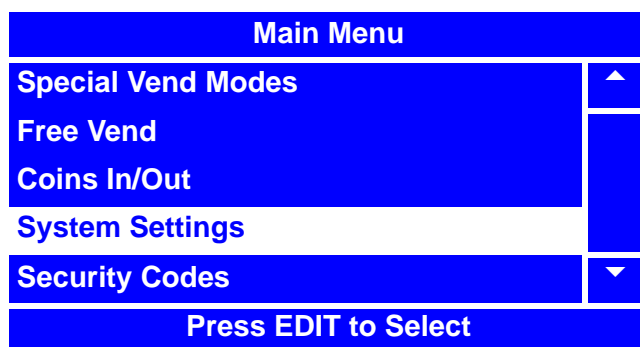

5. Press  to lock in the selection and return to the **Monetary** menu. Verify that the status (bottom) line displays the amount of change that **Change Without Purchase** is set for.

6. Press  once to return to the **System Settings** menu or twice to return to the **Main Menu**.





Set Low Change Message

1. Press  until you reach the **Main Menu**, then use  or  to select **System Settings**.

2. In the **System Settings** menu, use  or  to select **Monetary** and press .

NOTE

The **Low Change Message** menu selection is only available when a **Coin Mechanism** is activated. See “Select the Coin Mechanism” on page 139.

3. In the **Monetary** menu, use  or  to select **Low Change Message** and press .





4. Using the number keys on either keypad, enter the amount of change that will be remaining when you wish the merchandiser to start displaying a “Low Change” message. If the amount of change is less than \$10.00, use leading zeros. The arrow keys will reposition the cursor.

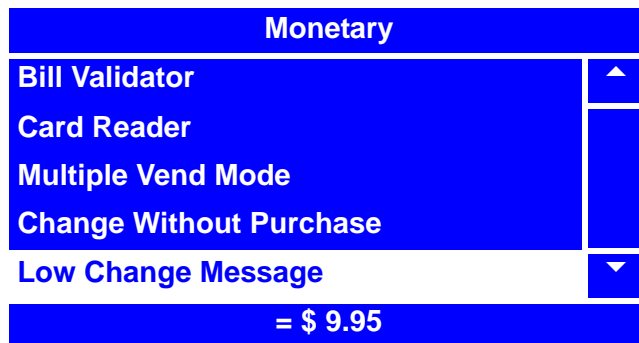
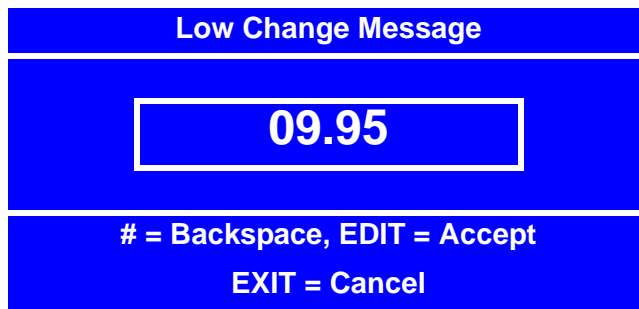
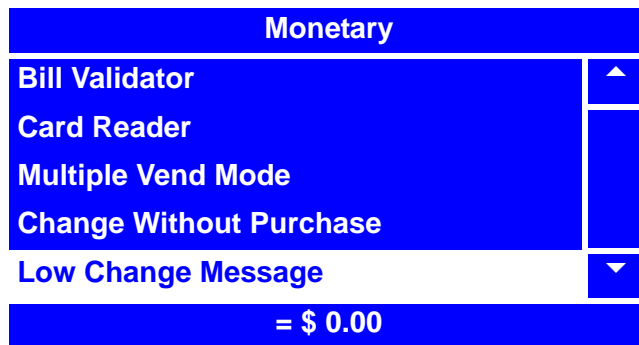
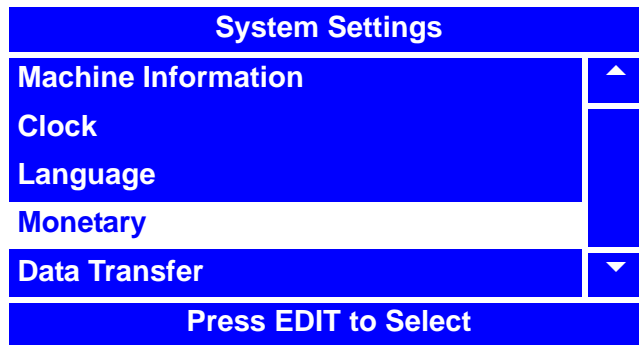
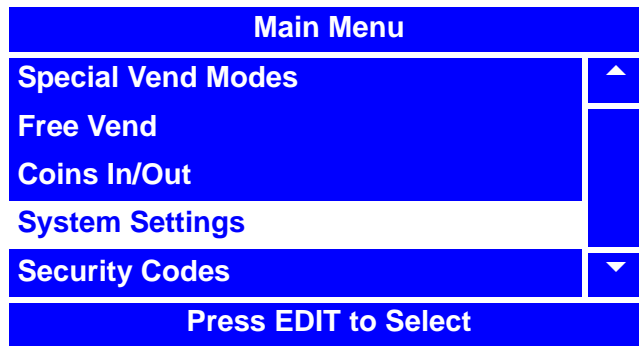

5. Press  to lock in the selection and return to the **Monetary** menu. Verify that the status (bottom) line displays the remaining change in the merchandiser when the **Low Change Message** is set to display.

6. Press  once to return to the **System Settings** menu or twice to return to the **Main Menu**.





Select the Bill Validator



1. Press  until you reach the **Main Menu**, then use  or  to select **System Settings** and press .

2. In the **System Settings** menu, use  or  to select **Monetary** and press .

NOTE

The selections in the **Monetary** menu may vary, depending upon how the selections for **Coin Mechanism**, **Bill Validator** and **Card Reader** are set. You will always be able to access **Bill Validator**.

3. In the **Monetary** menu, use  or  to select **Bill Validator** and press .





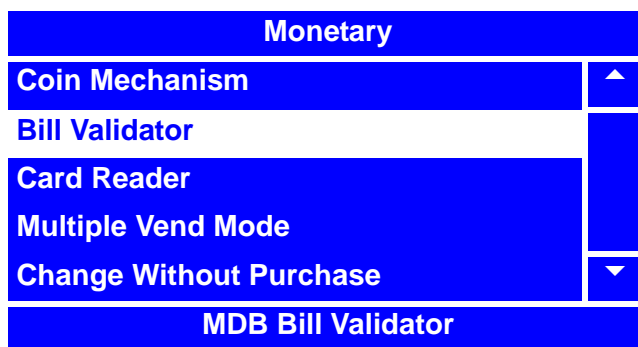
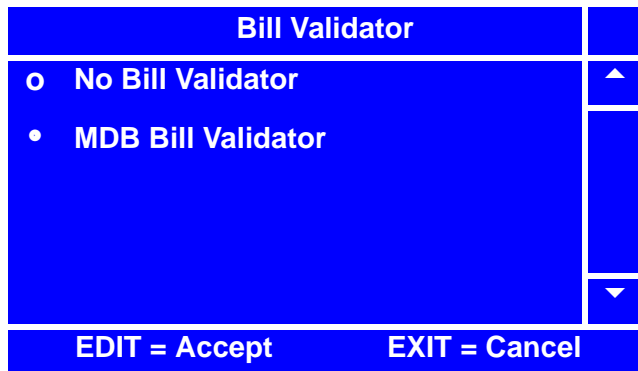
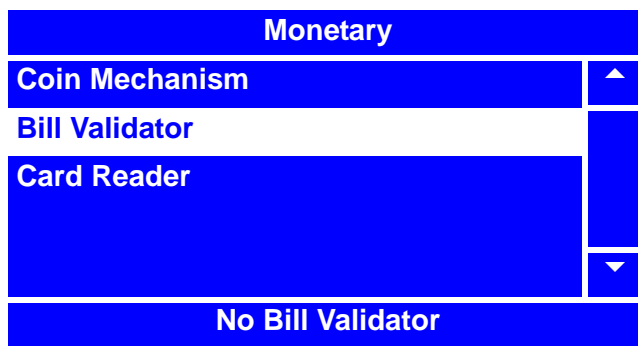
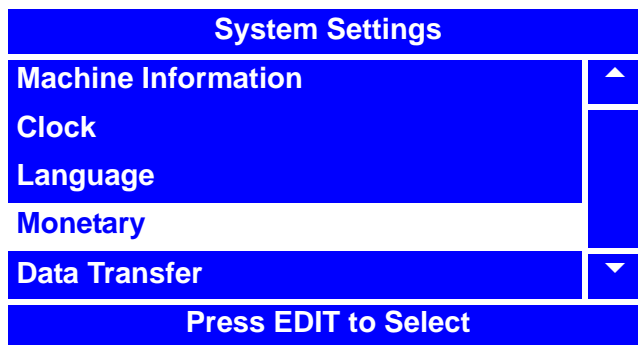
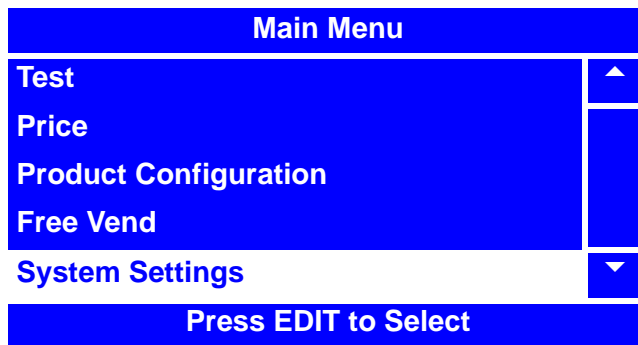

4. In the **Bill Validator** menu, press  or  to select the desired Bill Validator option. The selected option is the one with the filled-in circle.

5. Press  to lock in the selection and return to the **Monetary** menu. With **Bill Validator** selected, verify that the status (bottom) line displays your Bill Validator option selection.

6. Press  until you reach the **Main Menu**.
*You must do this to initialize the Bill Validator and activate the **Bill Acceptance** menu.*





Set Accept on Low Change

1. Press  until you reach the **Main Menu**, then use  or  to select **System Settings**.
2. In the **System Settings** menu, use  or  to select **Monetary** and press .

NOTE

The **Accept on Low Change** menu selection is only available when a **Coin Mechanism** and/or a **Bill Validator** are activated. See “Select the Coin Mechanism” on page 139 and/ or “Select the Bill Validator” on page 143.

3. In the Monetary menu, use  or  to select **Accept on Low Change** and press .
4. Using the number keys on either keypad, enter the **Accept on Low Change** value. The arrow keys will reposition the cursor. This value has two purposes:

A. This value tells the merchandiser how large a bill or coin to accept even though there is not enough change in the coin mech to cover all possible paybacks. For example: enter 01.00. In this case, the merchandiser will take a dollar bill or coin, even though there is less than \$1.00 worth of change in the coin mech.

Entering 05.00 tells the merchandiser to take a five dollar bill even though there is less than \$5.00 worth of change in the coin mech.

NOTE

This could cause a customer to be short-changed. Entering 00.00 means that bills or coins will only be accepted if there is enough change in the coin mech to cover the payback.

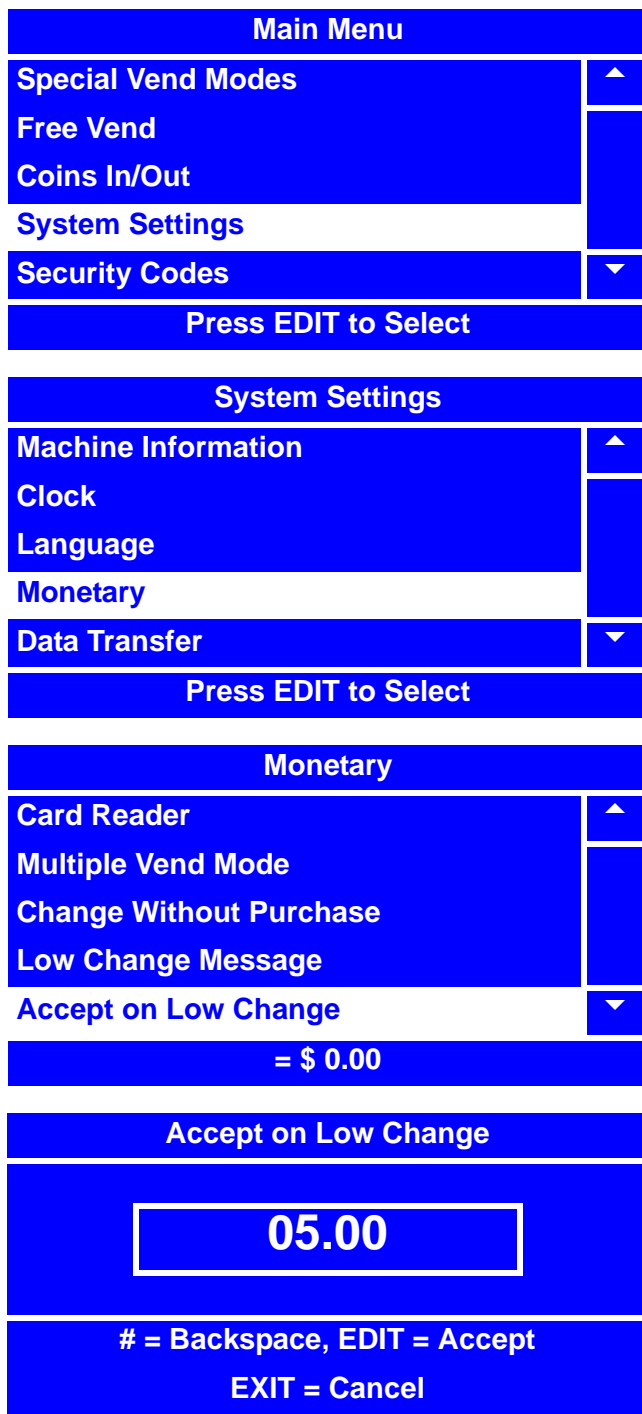



Set Accept on Low Change (continued)

B. This value also tell the merchandiser how much the customer is allowed to overbuy a product. The customer will be short-changed when an overbuy occurs.





For example: for a value of 00.25, if there is no change in the coin mech, and the customer inserts a \$1.00 bill, a \$0.75 product can be purchased even though change cannot be paid back. The customer will be short-changed. Normally, a purchase will not be approved unless all change can be paid. Entering 00.00 means that the vend will only be approved when the correct change can be returned (overbuy disabled).



Monetary	
Card Reader	▲
Multiple Vend Mode	
Change Without Purchase	
Low Change Message	
Accept on Low Change	▼
= \$ 5.00	

5. Press  to lock in the selection and return to the **Monetary** menu. Verify that the status (bottom) line displays the bill value that **Accept on Low Change** is set for.

6. Press  once to return to the **System Settings** menu or twice to return to the **Main Menu**.



Set Bill Acceptance

1. Press  until you reach the **Main Menu**, then use the  or  to select **System Settings** and press .



2. In the **System Settings** menu, use  or  to select **Monetary** and press .

NOTE

The **Bill Acceptance** menu selection is only available when a **Bill Validator** is activated. See "Select the Bill Validator" on page 143.

3. In the Monetary menu, use  or  to select **Bill Acceptance** and press .

4. In the **Bill Acceptance** menu, select the value of the bill you wish to set acceptance (**Off** or **On**) for and press .





5. In the "X" menu, press  or  to select **Off** or **On**. The selected option is the one with the filled-in circle.

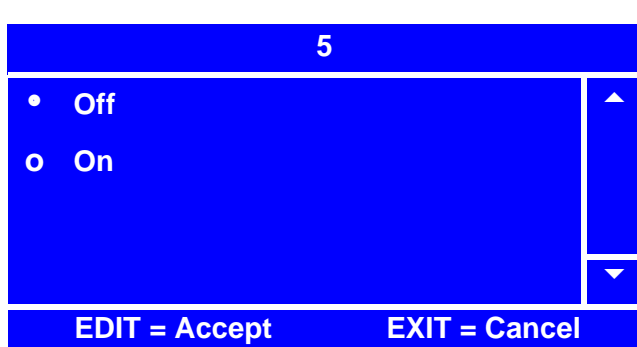
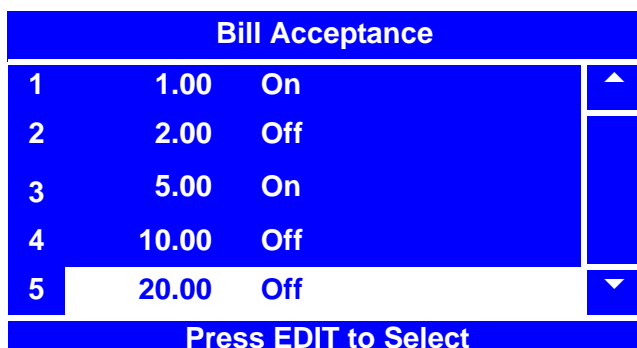
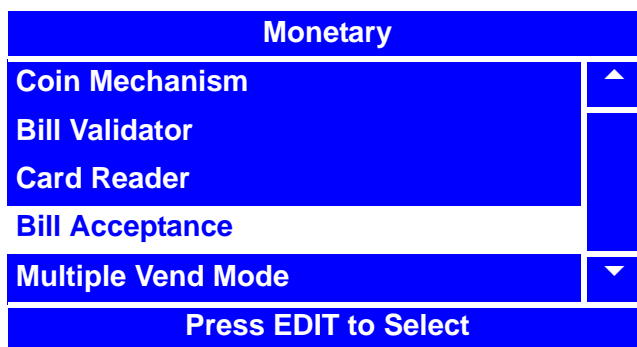
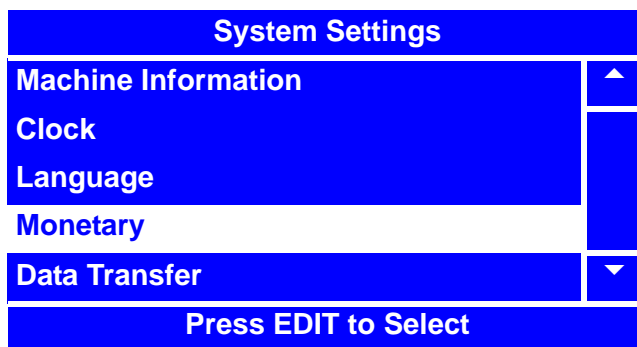
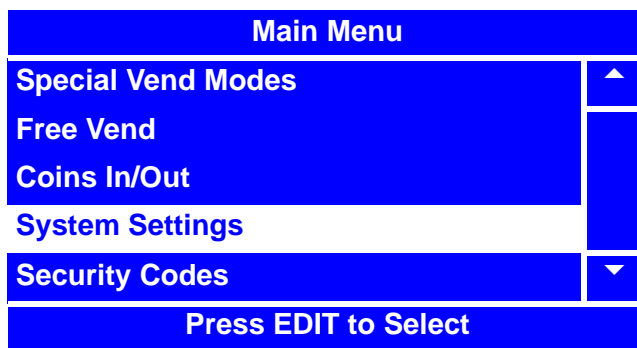

6. Press  to lock in your selection (**Off** or **On**) and return to the **Bill Acceptance** menu. Verify that the status displayed next to the bill values is are correct.

7. Press  once to return to the **System Settings** menu, or twice to return to the **Main Menu**.





Set Token/Coupon Acceptance

1. Press  until you reach the **Main Menu**, then use the  or  to select **System Settings** and press .



2. In the **System Settings** menu, use  or  to select **Monetary** and press .

NOTE

The **Bill Acceptance** menu selection is only available when a **Bill Validator** is activated. See "Select the Bill Validator" on page 143.

3. In the Monetary menu, use  or  to select **Bill Acceptance** and press .

4. In the **Bill Acceptance** menu, select **Token 1** and press .

5. In the "6" menu, press  or  to select **Off** or **On**. The selected option is the one with the filled-in circle.

NOTE





Selections must be enabled in the **Special Vend Modes** menu for token and coupon acceptance to function properly. See "Token Enable" on page 128

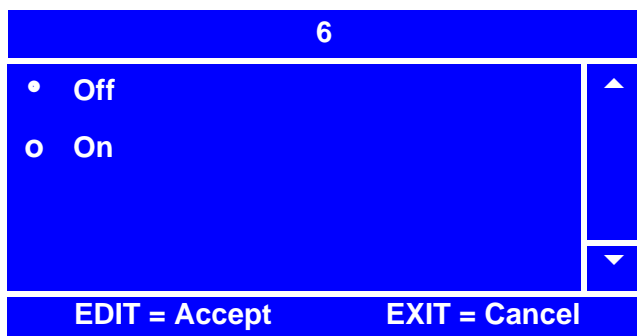
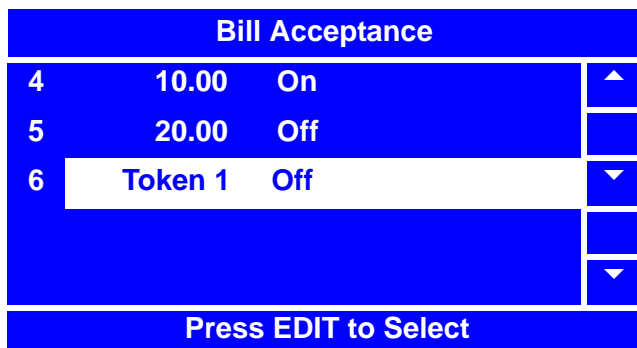
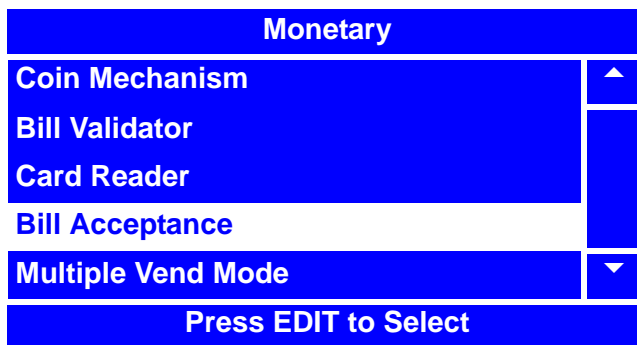
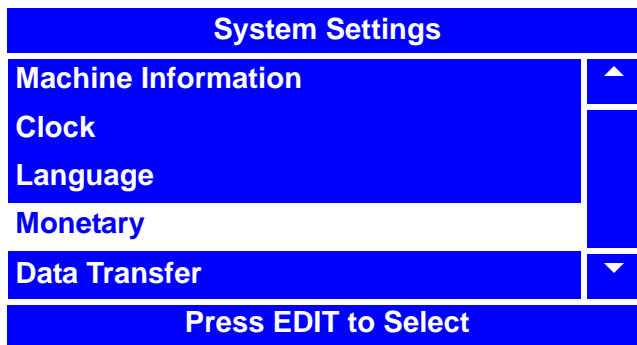
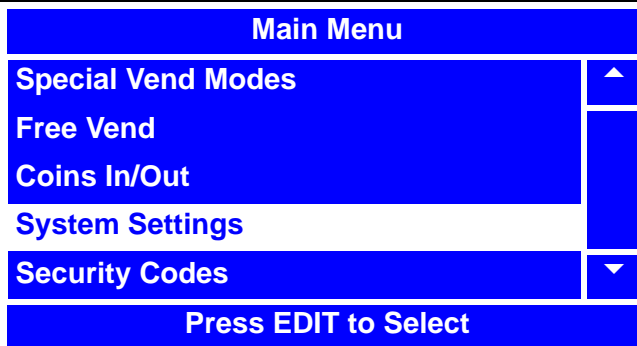

6. Press  to lock in your selection (**Off** or **On**) and return to the **Bill Acceptance** menu. Verify that the status displayed next to Token 1 is correct.

7. Press  once to return to the **System Settings** menu, or twice to return to the **Main Menu**.





Select the Card Reader



1. Press  until you reach the **Main Menu**, then use  or  to select **System Settings** and press .

2. In the **System Settings** menu, use  or  to select **Monetary** and press .

NOTE

The selections in the **Monetary** menu may vary, depending upon how the selections for **Coin Mechanism**, **Bill Validator** and **Card Reader** are set. You will always be able to access **Card Reader**.

3. In the **Monetary** menu, use  or  to select **Card Reader** and press .

4. In the **Card Reader** menu, press  or  to select the desired Card Reader option. The selected option is the one with the filled-in circle.



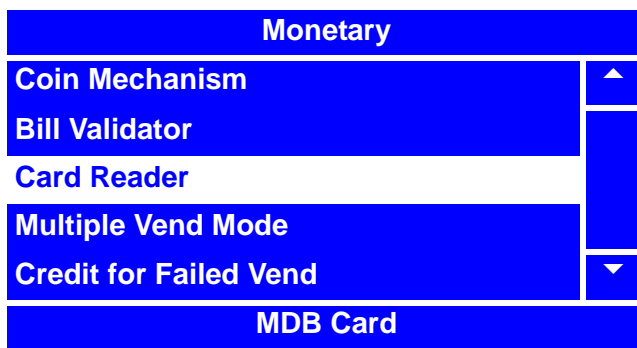
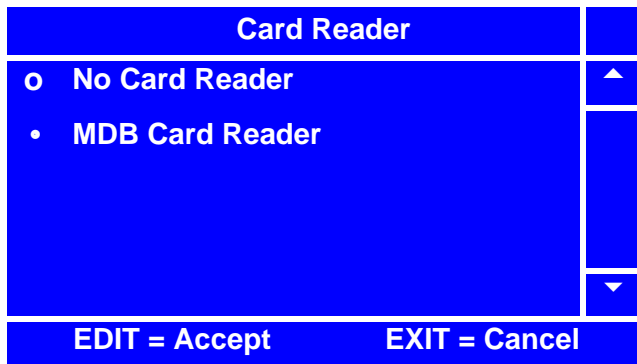
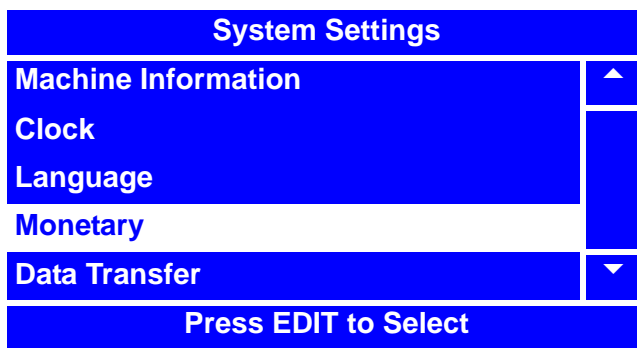
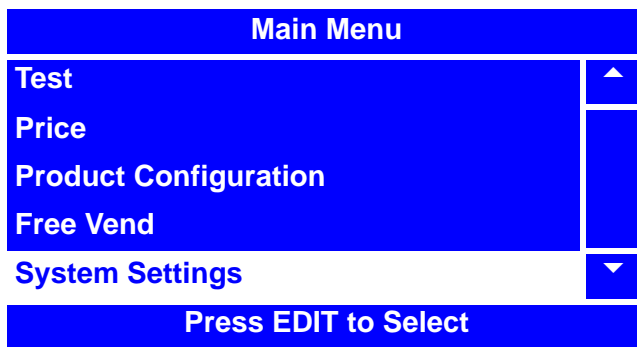

5. Press  to lock in the selection and return to the **Monetary** menu. With **Card Reader** selected, verify that the status (bottom) line displays your Card Reader option selection.



6. Press  once to return to the **System Settings** menu or twice to return to the **Main Menu**.



Set Card Revalue







Card Revalue set to **On** will allow customers to insert a card, then insert money and have credit applied to their card.

- Press  until you reach the **Main** Menu, then use  or  to select **System Settings** and press .

- In the **System Settings** menu, use  or  to select **Monetary** and press .

NOTE

The **Card Revalue** selection will not be available unless a **Card Reader** is selected. See “Select the Card Reader” on page 148.

- In the **Monetary** menu, press  or  to select **Card Revalue** and press .
- In the **Card Revalue** menu, press  or  to select **On** or **Off**. The selected option is the one with the filled-in circle.
- Press  to lock in the selection and return to the **Monetary** menu.

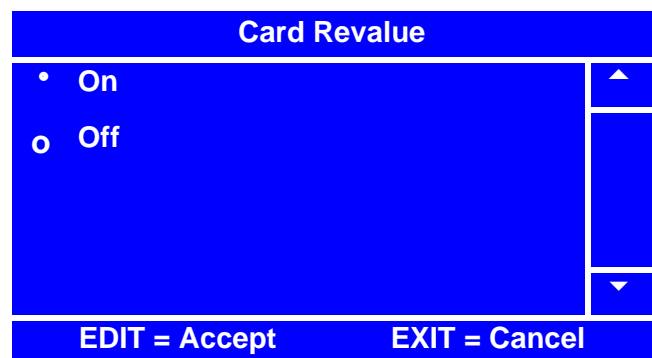
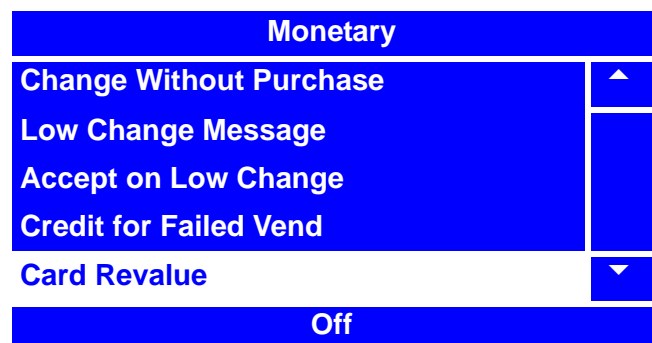
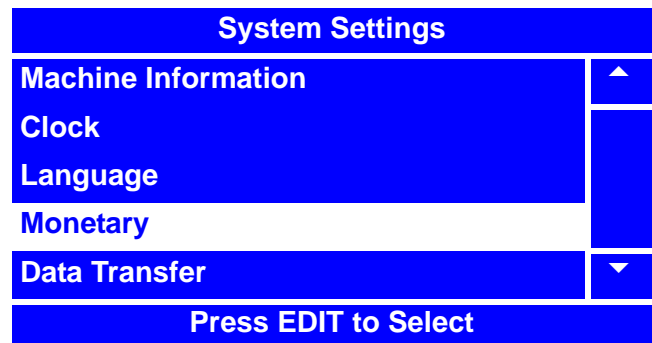
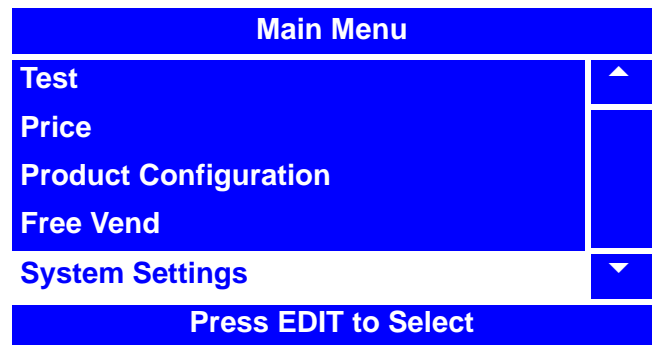

Set Card Revalue (continued)

- 6. Verify that the status (bottom) line of the **Monetary** menu displays the selected option (**On** or **Off**) when **Card Revalue** is highlighted.

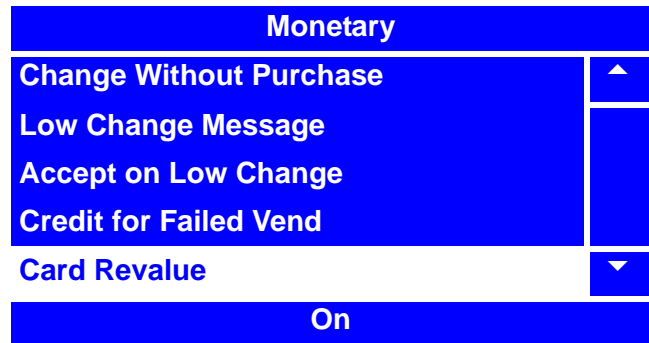







- 7. Press  once to return to the **System Settings** menu or twice to return to the **Main Menu**.

Set Multiple Vend Mode

The **Multiple Vend Mode** option specifies how the merchandiser will dispense change once a purchase is made. There are two **Multiple Vend Mode** options:

- a. **Single Vend** - change is dispensed as soon as a valid selection is made.
- b. **Multi Vend** - also called Declining Balance. The customer can make multiple vends as long as there is sufficient credit. In order to get change, the customer *must* press the coin return.



1. Press  until you reach the **Main Menu**, then use  or  to select **System Settings** and press .

2. In the **System Settings** menu, use  or  to select **Monetary** and press .

NOTE

The **Multiple Vend Mode** menu selection is only available when one or any combination of **Coin Mechanism, Bill Validator or Card Reader** are activated. See “Select the Coin Mechanism” on page 139, “Select the Bill Validator” on page 143 and/or “Select the Card Reader” on page 148.

3. In the **Monetary** menu, select **Multiple Vend Mode** and press .

4. In the **Multiple Vend Mode** menu, press  or  to select the desired option. The selected option is the one with the filled-in circle.

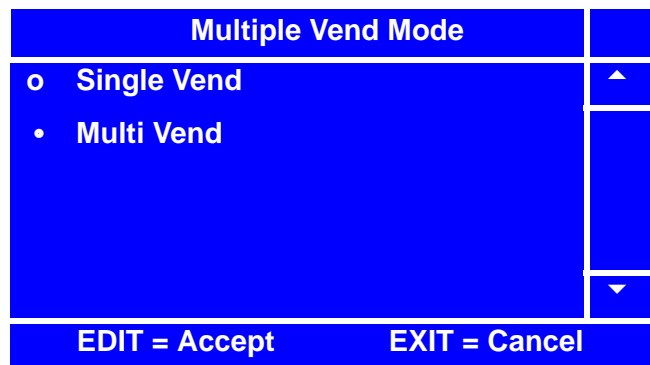
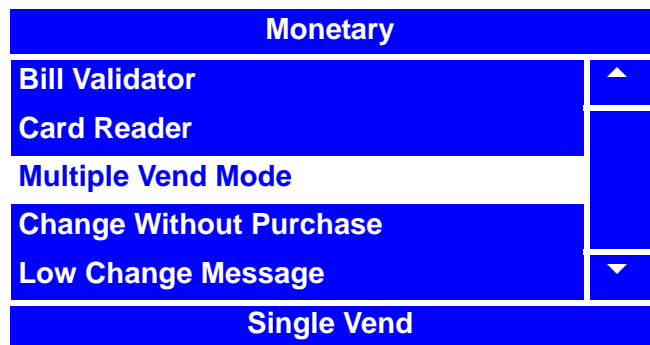
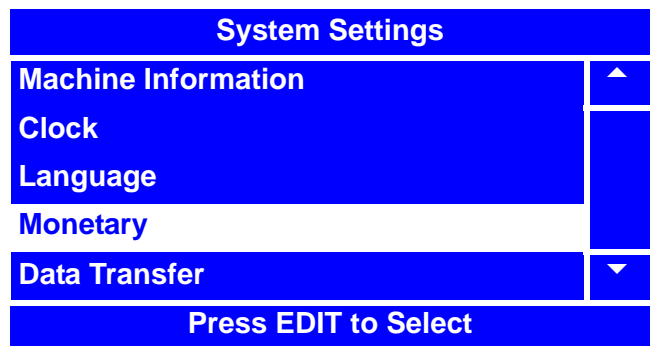
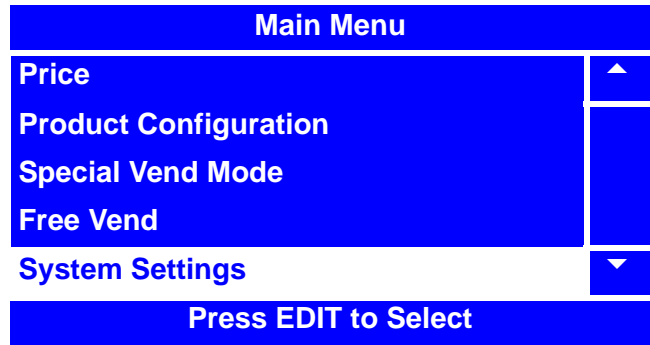

Set Multiple Vend Mode (continued)

5. Press  to lock in the selection and return to the **Monetary** menu.

6. Verify that the status (bottom) line displays the selected option when **Multiple Vend Mode** is highlighted.



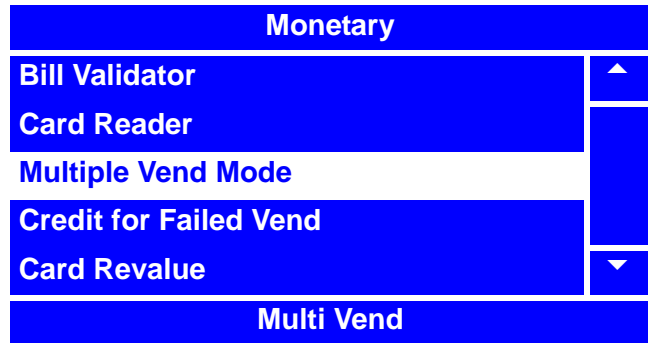

7. Press  once to return to the **System Settings** menu or twice to return to the **Main Menu**.





Set Credit for Failed Vend

If a failed vend occurs, the customer's money may be returned, or the customer's credit could be restored to the merchandiser for another selection. There are two **Credit for Failed Vend** options:

- a. **Hold Credit** - this allows the customer's credit to be restored to the merchandiser for another selection.
- b. **Return Change** - this allows for the customer's money to be returned.



1. Press  until you reach the **Main Menu**, then use  or  to select **System Settings** and press .

2. In the **System Settings** menu, use  or  to select **Monetary** and press .

NOTE

The **Credit for Failed Vend** menu selection is only available when one or any combination of **Coin Mechanism**, **Bill Validator** or **Card Reader** are activated. See "Select the Coin Mechanism" on page 139, "Select the Bill Validator" on page 143 and/or "Select the Card Reader" on page 148.

3. In the **Monetary** menu, select **Credit for Failed Vend** and press .

4. In the **Credit for Failed Vend** menu, press  or  to select the desired option. The selected option is the one with the filled-in circle.

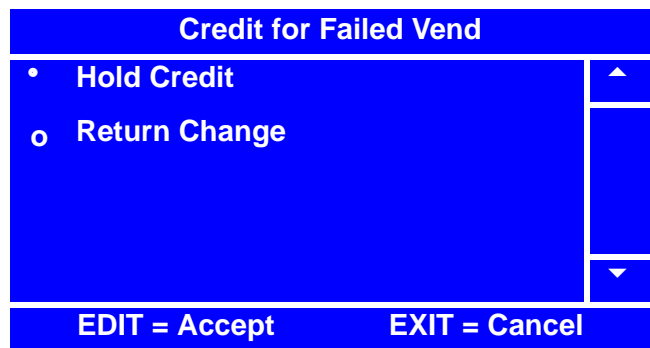
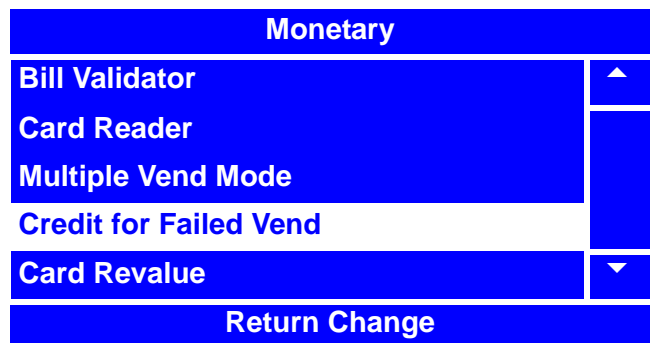
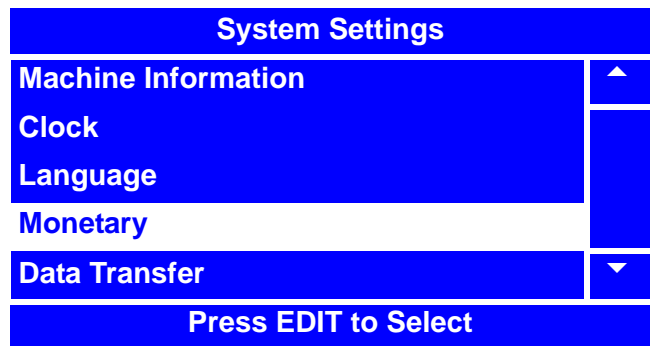
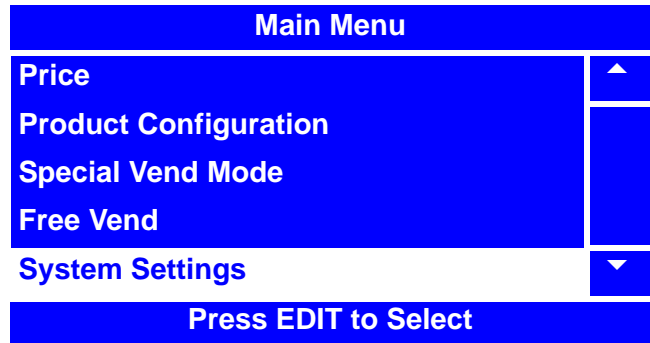

Set Credit for Failed Vend (continued)

5. Press  to lock in the selection and return to the **Monetary Menu**.



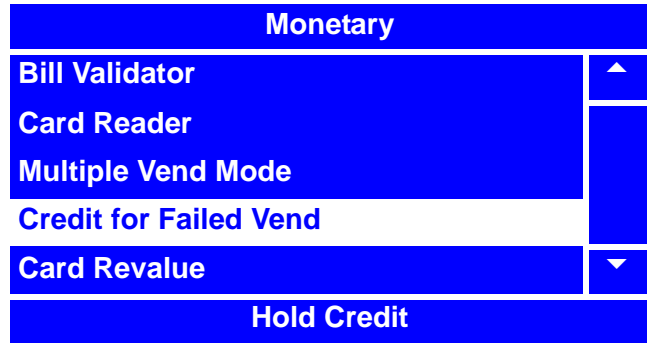









6. In the **Monetary** menu, verify that the option you selected matches the status (bottom) line when **Credit for Failed Vend** is selected.



7. Press  once to return to the **System Settings** menu or twice to return to the **Main Menu**.



Set Data Transfer

Set Communication Mode

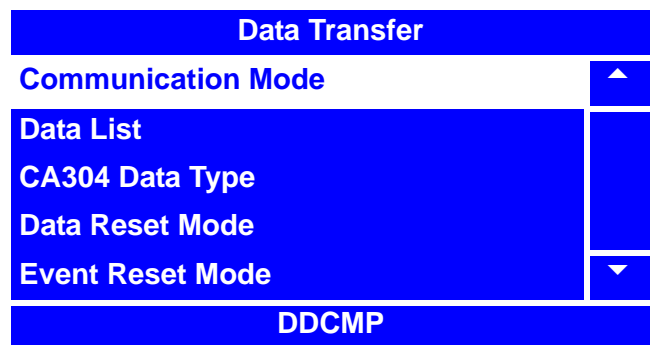
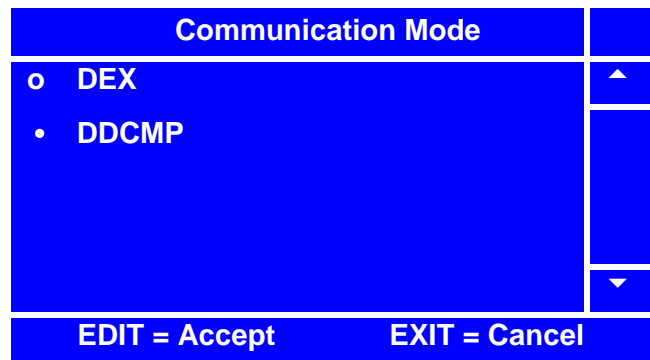
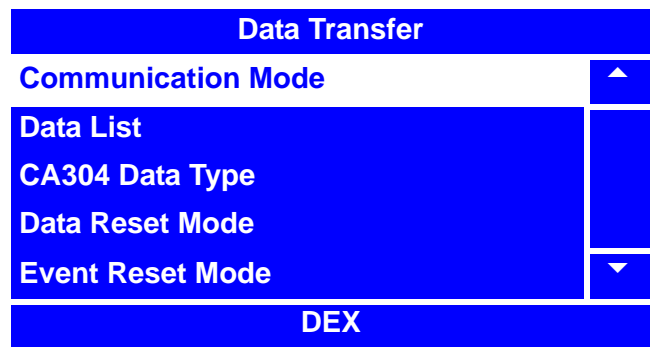
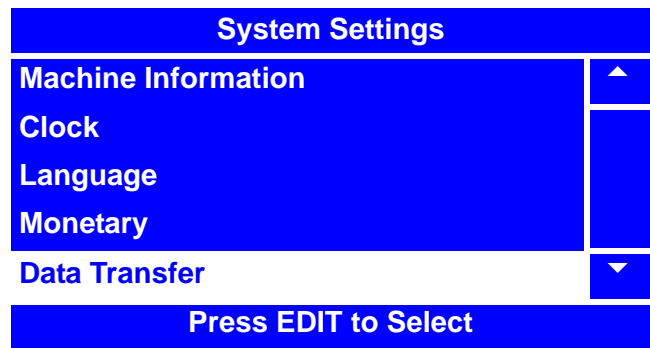
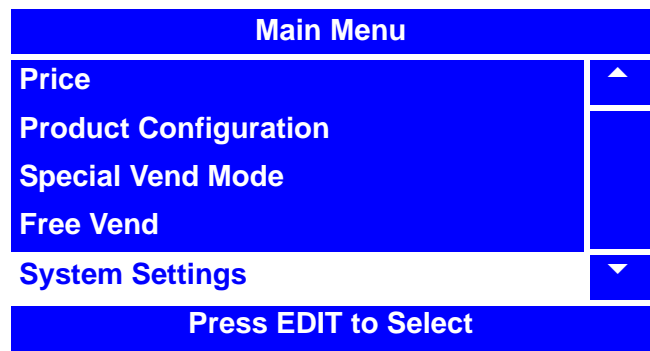

- Press  until you reach the **Main Menu**, then use  or  to select **System Settings** and press .
- In the **System Settings** menu, use  or  to select **Data Transfer** and press .
- In the **Data Transfer** menu, use  or  to select **Communication Mode** and press .
- In the **Communication Mode** menu, use  or  to select the desired option. (This sets the desired data collection mode. DEX is most commonly used in the US.) The selected option is the one with the filled-in circle.
- Press  to lock in the selection and return to the **Data Transfer** menu.
- In the **Data Transfer** menu, verify that the option you selected matches the status (bottom) line of the display when **Communication Mode** is selected.
- Continue on to the next procedure to "Set Data List" on page 156.

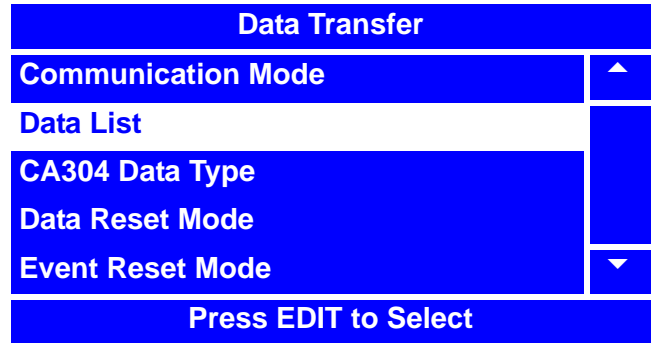

Set Data List

1. In the **Data Transfer** menu, use  or  to select **Data List** and press .



2. In the **Data List** menu, use  or  to highlight a selection and press  to enable or disable it. Enabled selections will have an “X”(s) to the left.

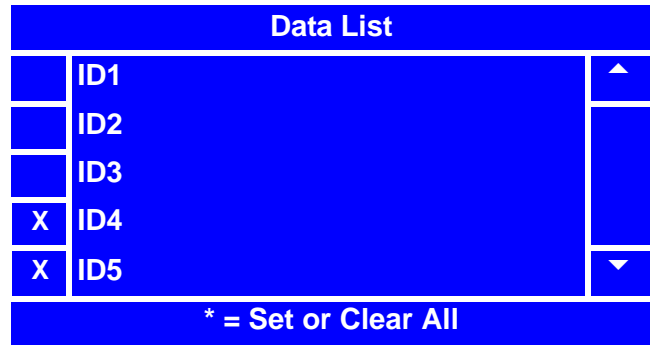

NOTE

By pressing , you are able to quickly remove or add the “X”(s) from all of the selections.

3. Press  once to return to the **Data Transfer** menu.

4. Continue on to the next procedure to “Set CA304 Data Type” on page 157.

Set CA304 Data Type

- In the **Data Transfer** menu, use



- In the **CA304 Data Type** menu, use

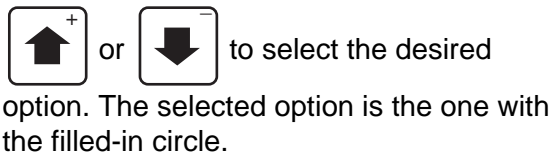

NOTE

Currency - the value of bills in the stacker will be transmitted in a cash format. For example, 200 for two dollars. (Currency is the default setting.)

Numeric - the value of the bills in the stacker will be transmitted in a dollar-count format. For example, 2 for two dollars.

- Press **EDIT** to lock in the selection and return to the **Data Transfer** menu. Verify that the selected option is displayed in the status (bottom) line when **CA304 Data Type** is selected.

NOTE

If your bill count is incorrect, the **CA304** setting may be wrong. Try using the opposite CA304 setting.

- Continue on to the next procedure to “Set Data Reset Mode” on page 158.

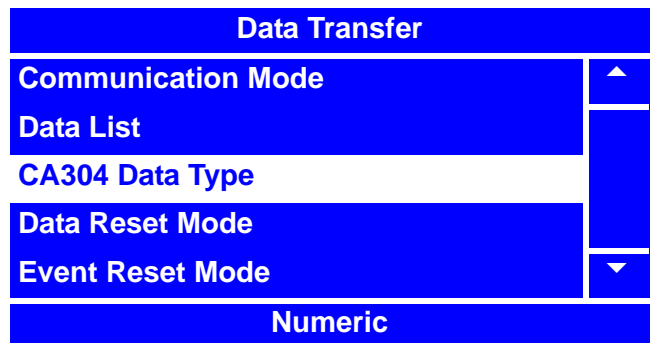
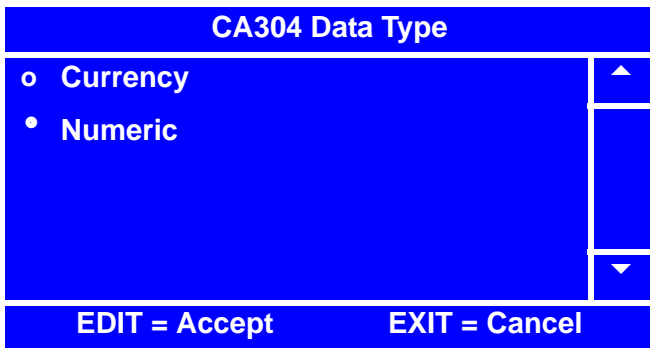
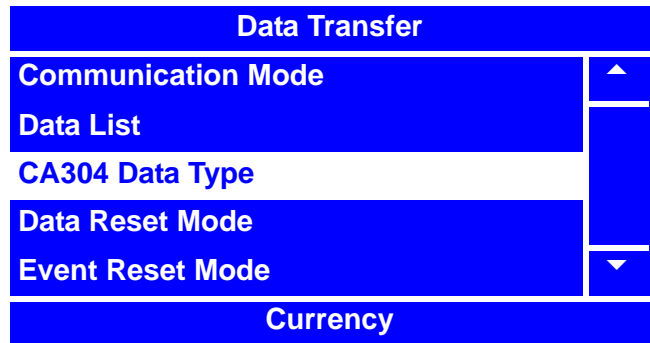

Set Data Reset Mode

1. In the **Data Transfer** menu, use



Data Reset Mode and press .

2. In the **Data Reset Mode** menu, use



(Reset On Transfer or No Reset On Transfer) option. The selected option is the one with the filled-in circle.

3. Press  to lock in the selection and return to the **Data Transfer** menu. Verify that the selected option is displayed in the status (bottom) line of the menu when **Data Reset Mode** is selected.

4. Continue on to the next procedure to “Set Event Reset Mode” on page 159.

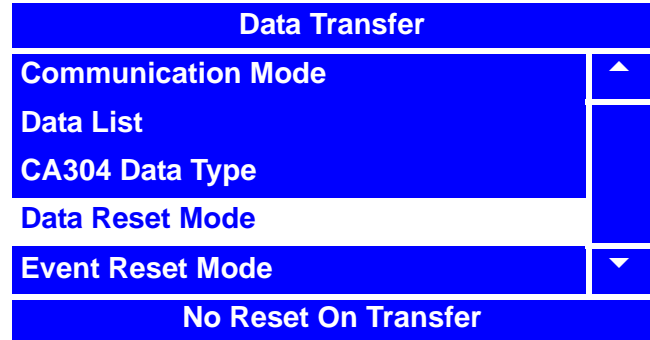
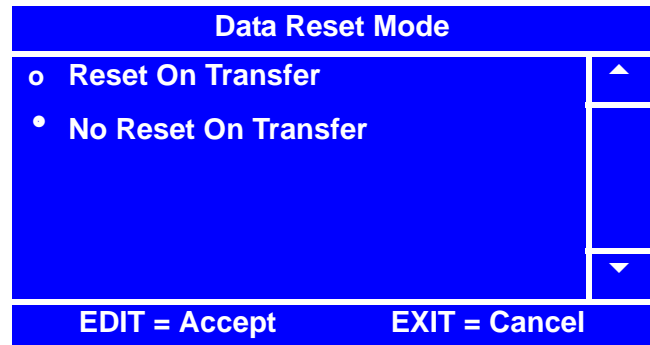
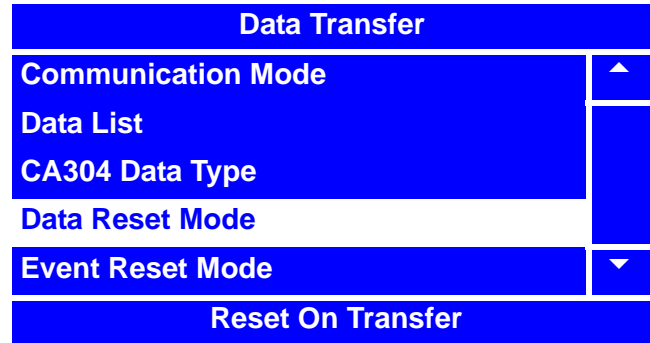

Set Event Reset Mode

1. In the **Data Transfer** menu, use



Event Reset Mode and press .

2. In the **Event Reset Mode** menu, use

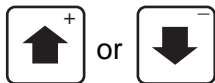
 to select the desired (**Reset On Transfer** or **No Reset On Transfer**) option. The selected option is the one with the filled-in circle.

3. Press  to lock in the selection and return to the **Data Transfer** menu. Verify that the selected option is displayed in the status (bottom) line of the menu when **Event Reset Mode** is selected.

4. Continue on to the next procedure to “Set Printer Baud Rate” on page 160.

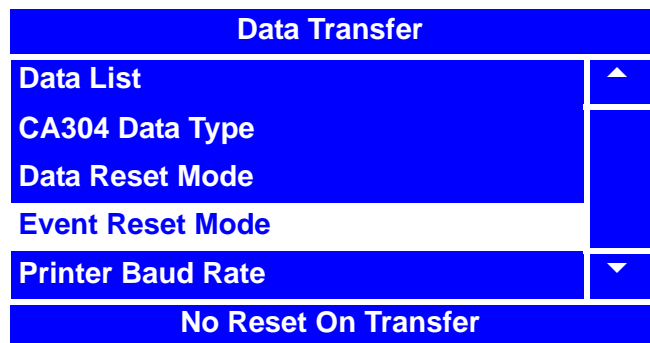
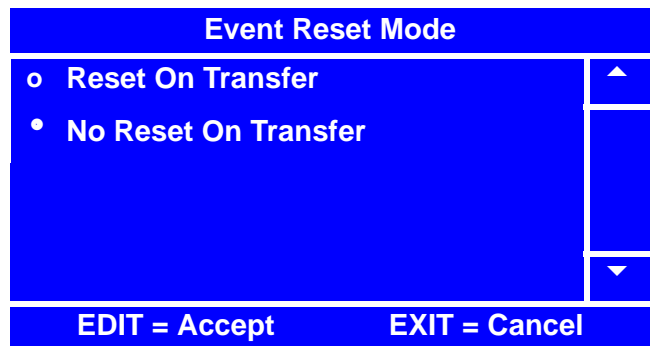
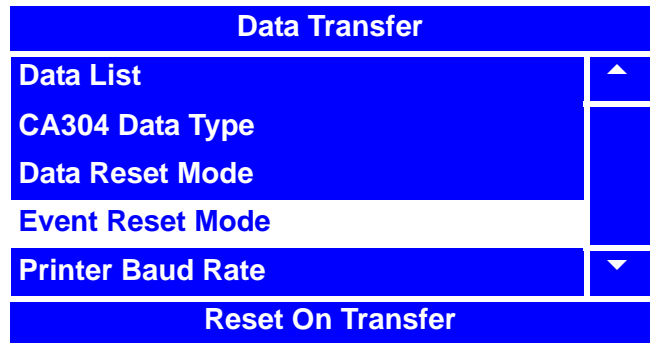

Set Printer Baud Rate

1. In the **Data Transfer** menu, use



to select

Printer Baud Rate and press



2. In the **Printer Baud Rate** menu, use

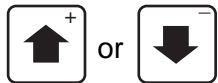



to select the desired

option. The selected option is the one with the filled-in circle.

NOTE

The **Printer Baud Rate** is the rate that information is passed from the main controller to the buffer so that data can be printed. Failure to set the proper **Printer Baud Rate** will cause the printer to not print all the data in a legible format.

3. Press  to lock in the selection and return to the **Data Transfer** menu. Verify that the selected option is displayed in the status (bottom) line of the menu when **Printer Baud Rate** is selected.

4. Press  once to return to the **System Settings** menu or twice to return to the **Main Menu**.

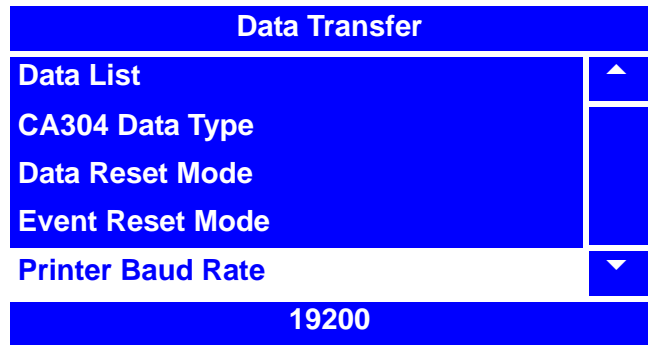
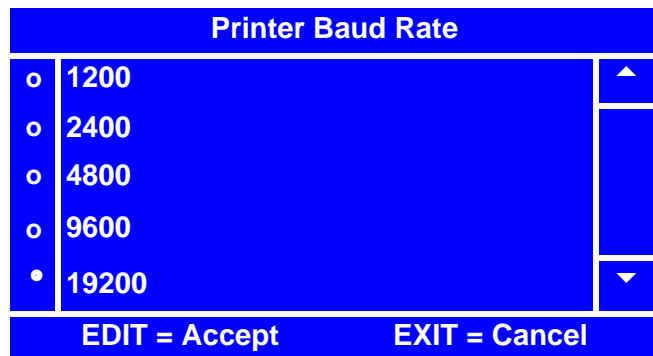
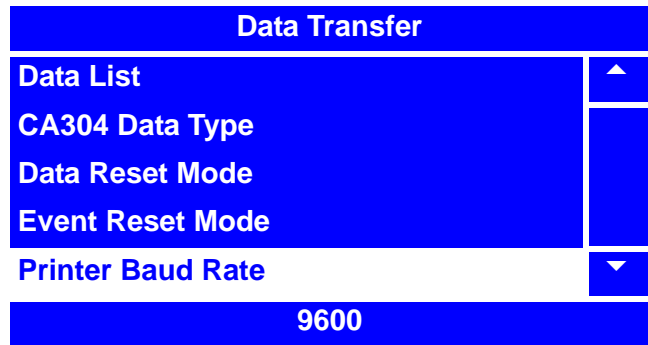

Connect and Disconnect the Data Key

1. Turn off power to the machine.
2. Open monetary door and remove circuit board cover.
3. Install the Data Key onto the main controller at J9A, as shown in figure below. Note the proper orientation of the Data Key onto the PCB header.

WARNING

**Use care when powering up the machine,
due to high voltage components and parts.**

4. Turn on power to the machine.
5. Access the service keypad and display.
6. Perform the procedure(s) that you wish to perform while Data Key is installed.
7. Turn off power to the machine.
8. Carefully remove the Data Key from the PCB header of the main controller at J9A.
9. Re-install the circuit board cover.
10. Turn on power to the machine.

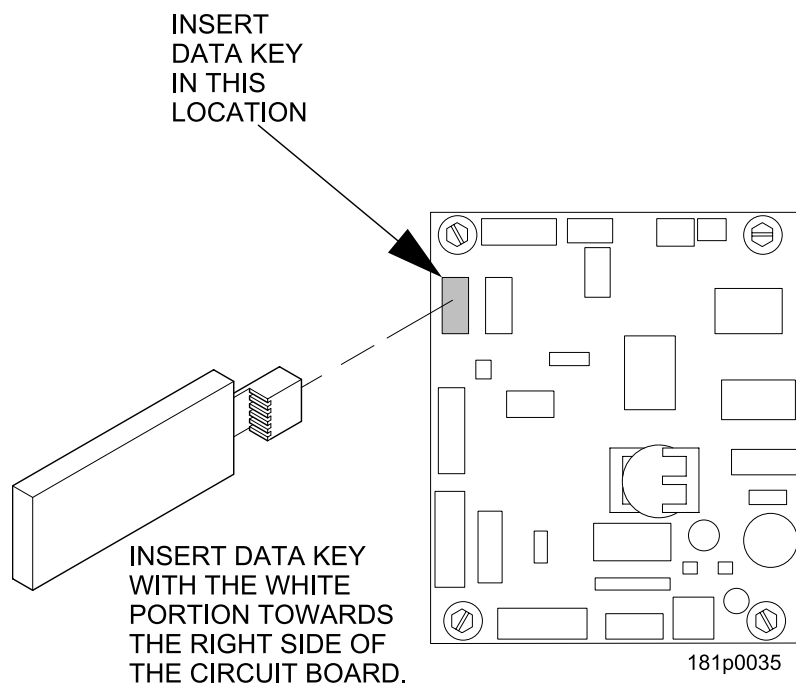

Firmware Selection (Serial Flash Menu)

The **Firmware** selection line in the **Serial Flash** menu will not always appear. This is because it may not be loaded up on the currently inserted Data Key.

If the **Firmware** selection line does appear, it is **IMPERATIVE** that you **DO NOT** attempt to perform this procedure.

WARNING

Loading or copying **Firmware** to the Data Key will result in the system software that operates the machine being transferred to the Data Key and **will cause your machine to be inoperable.**



DO NOT CHOOSE or try to perform this function!



System Settings	
Clock	▲
Language	
Monetary	
Data Transfer	
Serial Flash	▼
Press EDIT to Select	
Serial Flash	
Firmware	0
Configuration Data	0
Config & Sales Data	0
Press EDIT to Select	



Save Configuration Data to Data Key

This procedure allows you to copy data such as Custom Marketing Messages and Timed Events settings to the Data Key for back up and/or transfer to other machines.

1. Follow the instructions in "Connect and Disconnect the Data Key" on page 161 to install the Data Key



2. After installing the Data Key, access the **System Settings** menu by pressing  until you reach the **Main Menu**, then press  to scroll down to **System Settings** and press .



3. In the **System Settings** menu, press  to select **Serial Flash** and press .

4. In the **Serial Flash** menu, press  to select **Configuration Data** and press .

NOTE

If the Data Key has no configuration data stored, the only item displayed in the **Configuration Data** menu will be "Save Data."

5. In the **Configuration Data** menu, press  to select **Save Data** and press .

6. In the **Save Data** menu, press  to select a blank description line and press .

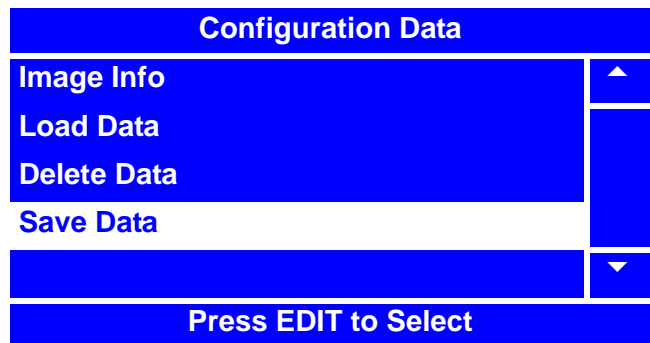
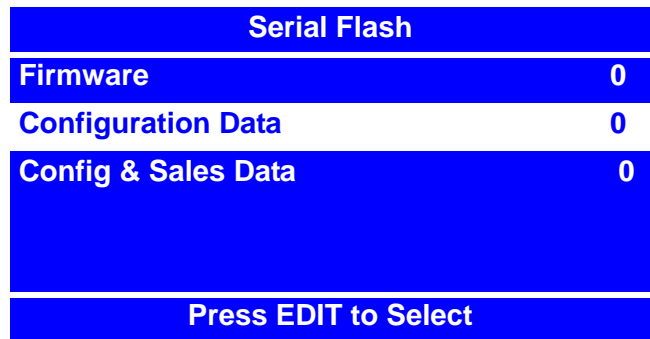
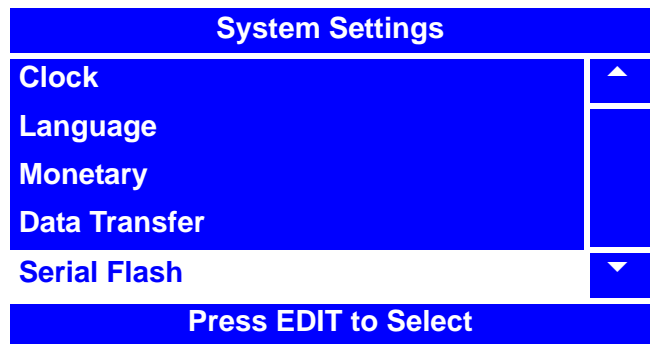

Save Configuration Data to Data Key (continued)

7. A second **Save Data** menu will appear.

Press  to select **Edit Description**

and press .

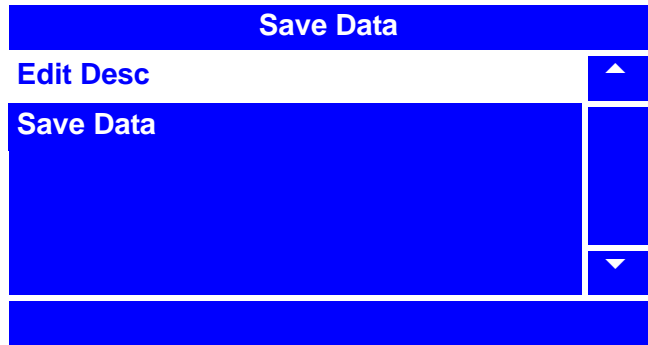

8. Enter a description of the data you are saving by using the keypad. Refer to the “NUMERIC/CHARACTER TABLE” on page 191.

Confirm by pressing .

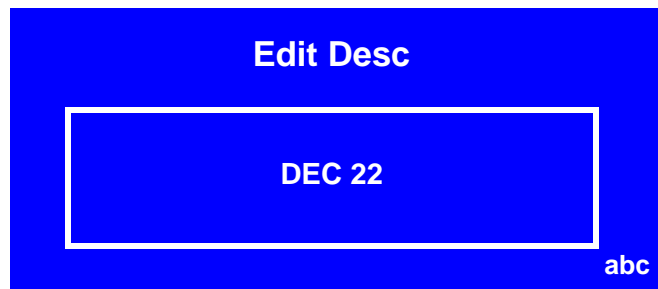

9. The screen will then return to the second

Save Data menu. Press  to select

Save Data and press  to confirm.

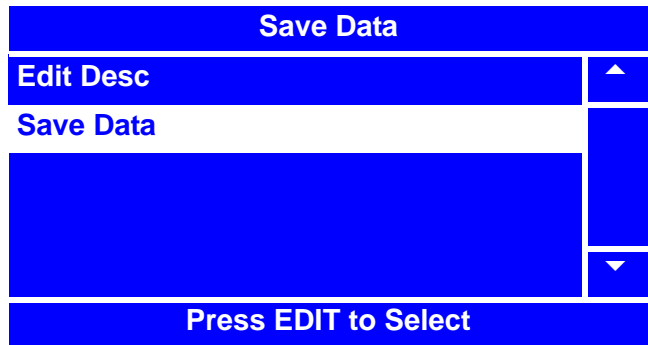

10. A third **Save Data** screen will appear, asking you if you are sure you want to save that particular Data Description from the

Data Key. Confirm by pressing .

The menu screen will then cycle to the **Ready** screen.

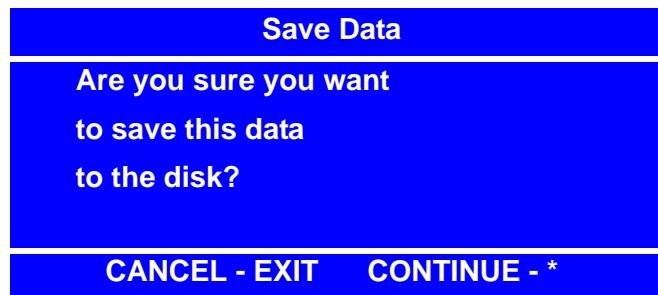



11. To confirm that the Data Description you entered was saved, follow the steps in “View Image Info (Data Description) on Data Key” on page 167.

12. Remove the Data Key (refer to “Connect and Disconnect the Data Key” on page 161.)



Save Configuration and Sales Data to Data Key

This procedure allows you to copy data such as Vend Totals or Sales Totals from the machine to the Data Key for back up.

1. Follow the instructions in “Connect and Disconnect the Data Key” on page 161 to install the Data Key.

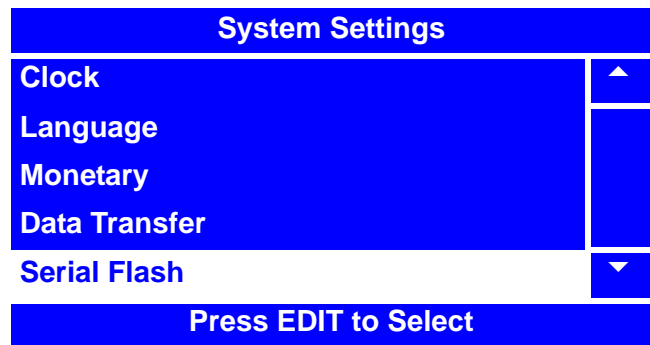
2. After installing the Data Key, access the **System Settings** menu by pressing  until you reach the **Main Menu**, then press  to scroll down to **System Settings** and press .



3. In the **System Settings** menu, press  to select **Serial Flash** and press .

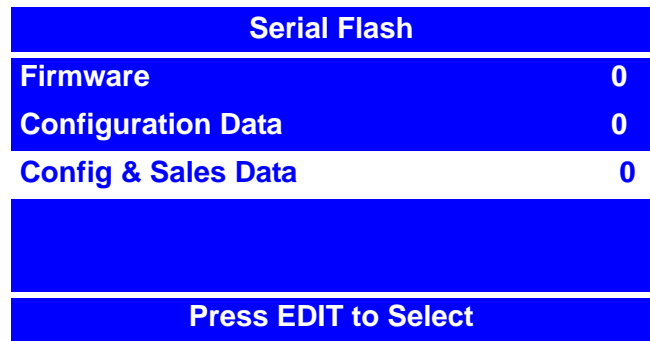



4. In the **Serial Flash** menu, press  to select **Config & Sales Data** and press .

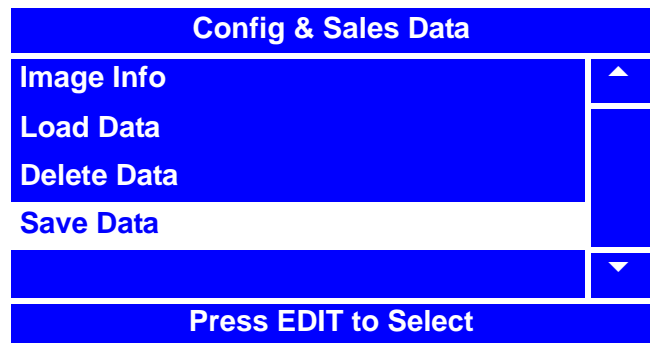

NOTE

If the Data Key has no configuration data stored, the only item displayed in the **Config & Sales Data** menu will be “**Save Data.**”



5. In the **Config & Sales Data** menu, press  to select **Save Data** and press .



6. In the **Save Data** menu, press  to select a blank description line and press .

Save Configuration and Sales Data to Data Key (continued)

7. A second **Save Data** menu will appear.

Press **EDIT** to select **Edit Description**

and press  .

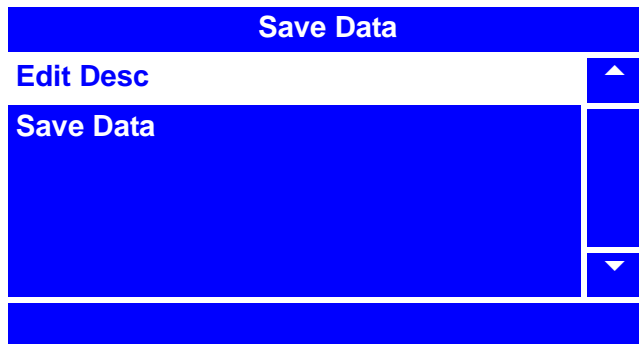

8. Enter a description of the data you are saving by using the keypad. Refer to the “NUMERIC/CHARACTER TABLE” on page 191.

Confirm by pressing  .



6. The screen will then return to the second

Save Data menu. Press **EDIT** to select

Save Data and press  to confirm.



7. A third **Save Data** screen will appear, asking you if you are sure you want to save that particular Data Description from the

Data Key. Confirm by pressing  .

The menu screen will then cycle to the **Ready** screen.

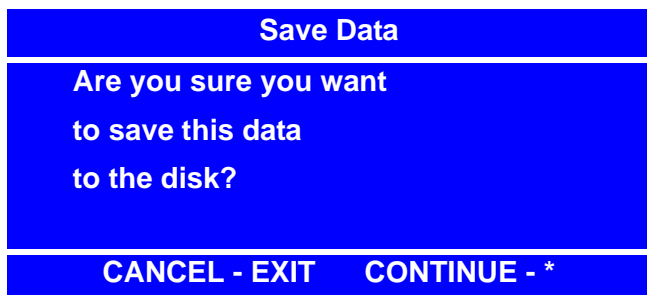

8. To confirm that the Data Description you entered was saved, follow the steps in “View Image Info (Data Description) on Data Key” on page 167.



9. Remove the Data Key (refer to “Connect and Disconnect the Data Key” on page 161.)

View Image Info (Data Description) on Data Key

NOTE

In performing this procedure, follow the instructions in “Connect and Disconnect the Data Key” on page 161 to install and remove the Data Key

1. After installing the Data Key, access the

System Settings menu by pressing  until you reach the **Main Menu**, then press  to scroll down to **System Settings** and press .

2. In the **System Settings** menu, press

to select **Serial Flash** and press .

NOTE

This procedure is performed in exactly the same manner whether using the **Configuration Data** or the **Config & Sales Data** functions.

3. In the **Serial Flash** menu, press

to select **Configuration Data** OR **Config & Sales Data** and press .

NOTE

If the Data Key has no data stored, the only item in the **Configuration Data** OR **Config & Sales Data** menu will be “**Save Data**,” In that case, there will be no Image Info to view.

4. In the **Configuration Data** OR **Config &**

Sales Data menu, press to select

Image Info and press .

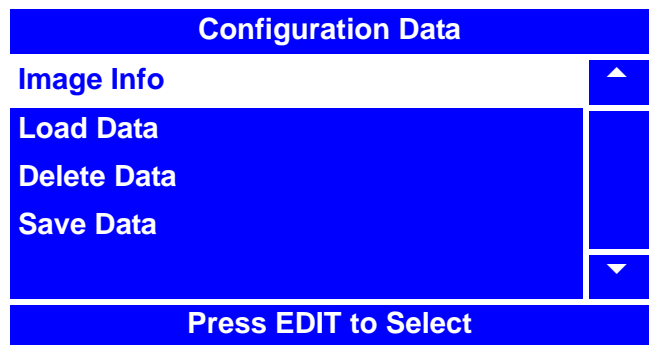
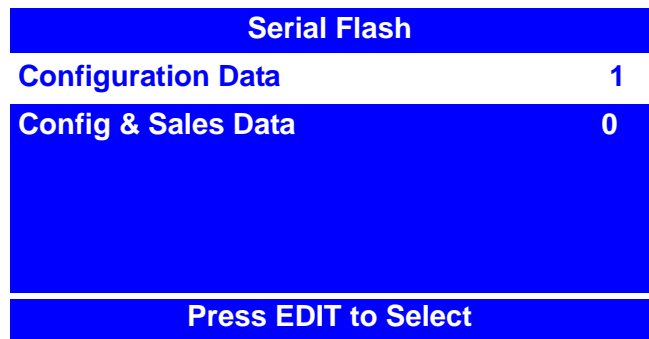
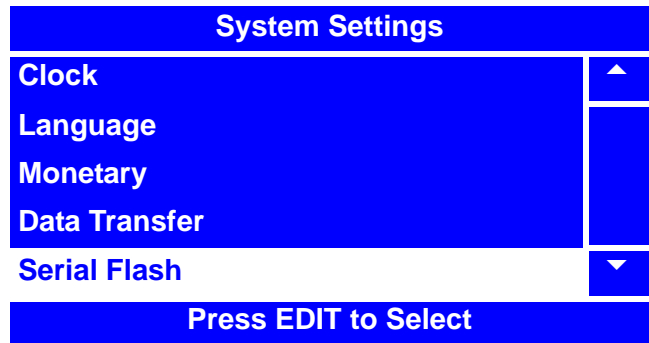

View Image Info (Data Description) on Data Key (continued)

NOTE

Image Info will initially be displayed as the original software version number (for example, in screen at right, it is 181.01.00.H) followed by the date the Image Info (Data Description) was saved. You will have to choose Image Info by selecting the date that it was originally saved.

Image Info		
1.	181.01.00.H	12/17/07
2.	181.01.00.H	11/15/07
3.	181.01.00.H	11/01/07
4.	_____	
5.	_____	
6.	_____	

- 5. In the **Image Info** menu, press  to select the Image Info you wish to display

and press .

- 6. A second **Image Info** screen will appear, displaying the software version, the Data Description that was originally entered, the date the data was saved, and the time the data was saved. In the example at right, the Data Description is displayed as **ABC123**.

Image Info	
Version:	181.01.00.H
Desc:	ABC123
Date:	12/17/07
Time:	10:15 AM

- 7. Press  once to return to the **Image Info** menu to choose another Data Description, twice to return to the **Configuration Data OR Config & Sales Data** menu to perform a different Data function, or several times to reach the **Main Menu**.

- 8. If you have finished performing all Data Key functions, remove the Data Key (refer to "Connect and Disconnect the Data Key" on page 161.)

Load Configuration Data from Data Key to Machine

NOTE

In performing this procedure, follow the instructions in "Connect and Disconnect the Data Key" on page 161 to install and remove the Data Key.

1. Access the **System Settings** menu by

pressing  until you reach the **Main**

Menu, then press  to scroll down to

System Settings and press .

2. In the **System Settings** menu, press

to select **Serial Flash** and press .

3. In the **System Settings** menu, press

to select **Serial Flash** and press .

4. In the **Serial Flash** menu, press
- to select **Configuration Data** and

press .

5. In the **Configuration Data** menu, press

to select **Load Data** and

press .

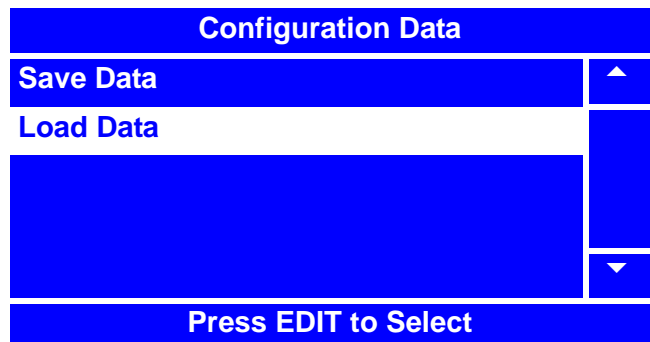
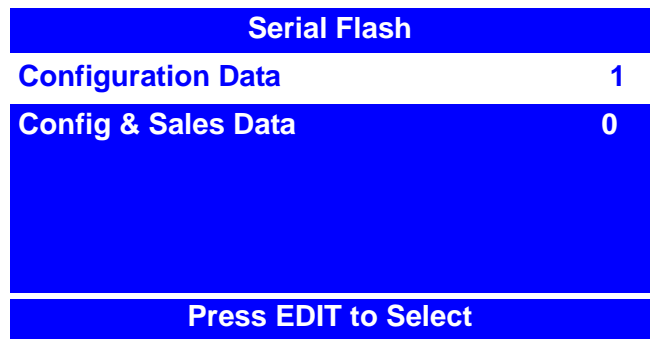
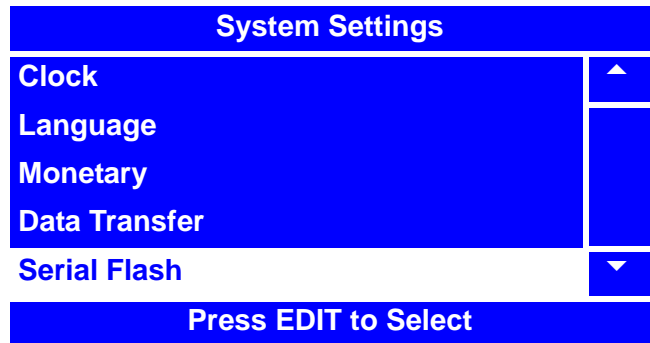

Load Configuration Data from Data Key to Machine (continued)

6. In the **Load Data** menu, press to select the Data Description you wish to copy and press .

Load Data		
1.	181.00.01.H	12/17/07
2.	181.00.01.H	11/15/07
3.	181.00.01.H	11/01/07
4.	-----	
5.	-----	
6.	-----	

7. A second **Load Data** screen will appear, asking you if you are sure you want to load that particular Data Description from the Data Key. Confirm by pressing .

Load Data	
Are you sure you want to load this image from the disk?	
CANCEL - EXIT	CONTINUE - *

8. The menu screen will then cycle to the **Ready** screen.

NOTE









You may wish to store Data Key Configuration Data to the machine's memory. To do so, follow the steps in "Backup Data" on page 174.

9. If you have finished performing all Data Key functions, remove the Data Key (refer to "Connect and Disconnect the Data Key" on page 161.)

Delete Configuration Data or Configuration and Sales Data from Data Key



NOTE

In performing this procedure, follow the instructions in "Connect and Disconnect the Data Key" on page 161 to install and remove the Data Key.

1. Access the **System Settings** menu by pressing  until you reach the **Main Menu**, then press  to scroll down to **System Settings** and press .
2. In the **System Settings** menu, press  to select **Serial Flash** and press .
3. In the **System Settings** menu, press  to select **Serial Flash** and press .
4. In the **Serial Flash** menu, press  to select **Configuration Data** OR **Config & Sales Data** and press .

NOTE

In the **Configuration Data** and **Config & Sales Data** menus, **Delete Data** will not appear unless there is data saved to the Data Key. If **Delete Data** does not appear, there is no data to delete.

5. In the **Configuration Data** OR **Config & Sales Data** menu, press  to select **Delete Data** and press .

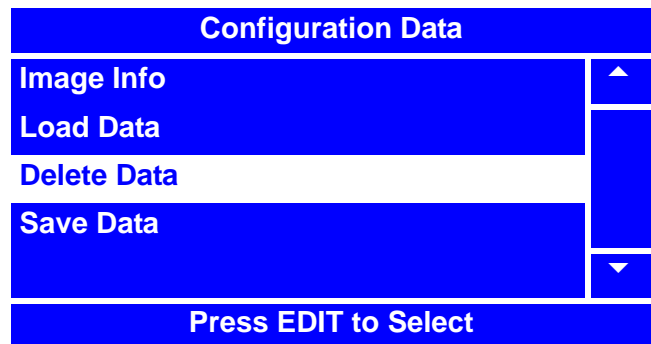
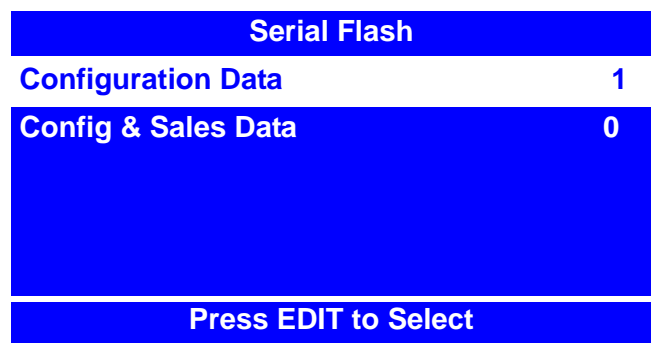
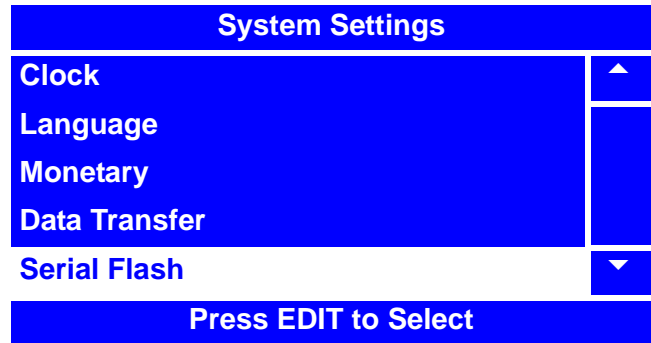

Delete Configuration Data or Configuration and Sales Data from Data Key (continued)

6. In the **Delete Data** menu, press  to select the Data Description you wish to delete and press .

Delete Data		
1.	181.00.01.H	12/17/07
2.	181.00.01.H	11/15/07
3.	181.00.01.H	11/01/07
4.	-----	
5.	-----	
6.	-----	

7. A second **Delete Data** screen will appear, asking you if you are sure you want to delete that particular Data Description from the

Data Key. Confirm by pressing .







Delete Data	
Are you sure you want to delete this image from the disk?	
CANCEL - EXIT	CONTINUE - *

8. The menu screen will then cycle to the **Ready** screen.

9. If you have finished performing all Data Key functions, remove the Data Key (refer to "Connect and Disconnect the Data Key" on page 161.)





View Last Backup

The backup features are used to backup up all settings and data in the event that there is a failure to the battery backup or the battery is changed out. It is recommended to backup the memory occasionally in the event of a failure.

1. Press  until you reach the **Main Menu**, then use  or  to select **System Settings** and press .
2. In the **System Settings** menu, use  or  to select **Backup/Restore Data** and press .

NOTE



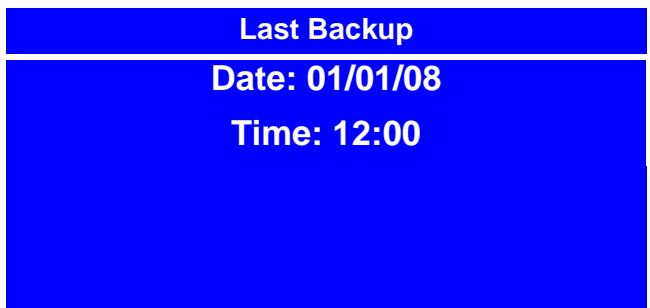
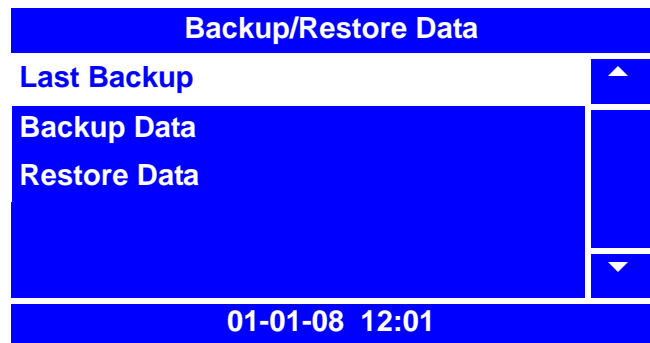
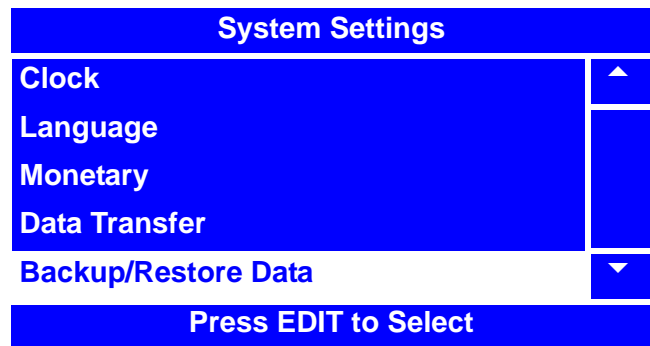
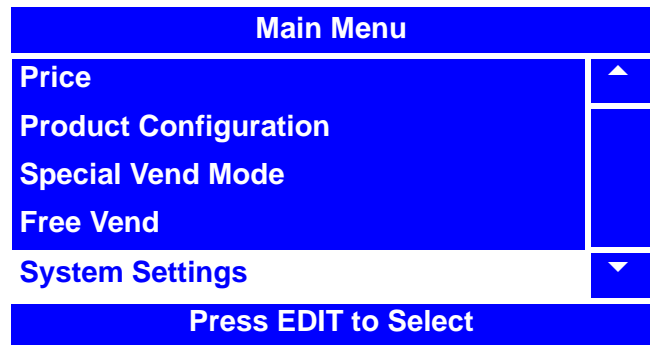

The **Last Backup** and **Restore Data** selections will not appear in the **Backup/Restore Data** menu unless data has previously been backed up.

3. In the **Backup/Restore Data** menu, use  or  to select **Last Backup** and press .
4. In the **Last Backup** screen, you can view the last time the data was backed up.
5. Press  once to return to the **Backup/Restore Data** menu, twice to return to the **System Settings** menu or three times to return to the **Main Menu**.





Backup Data

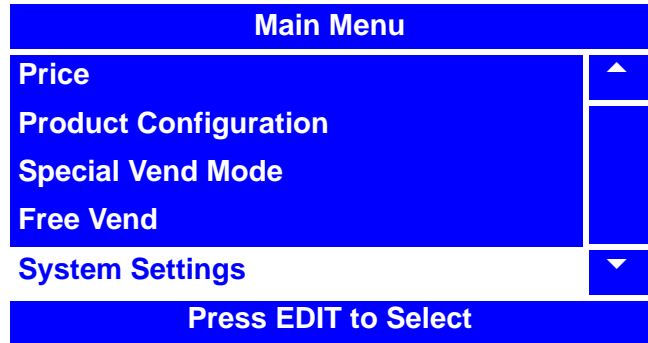

The backup features are used to backup up all settings and data in the event that there is a failure to the battery backup or the battery is changed out. It is recommended to backup the memory occasionally in the event of a failure

1. Press  until you reach the **Main** Menu, then use  or  to select **System Settings** and press .

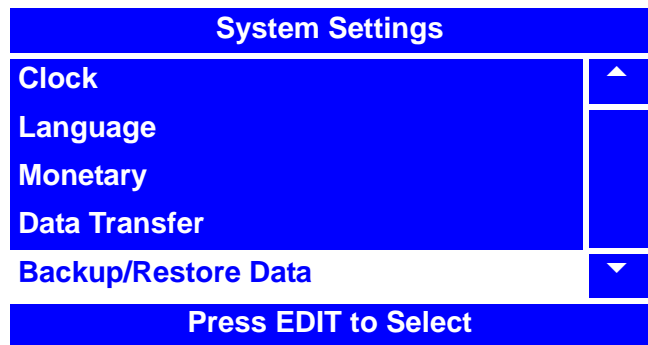

2. In the **System Settings** menu, use  or  to select **Backup/Restore Data** and press .



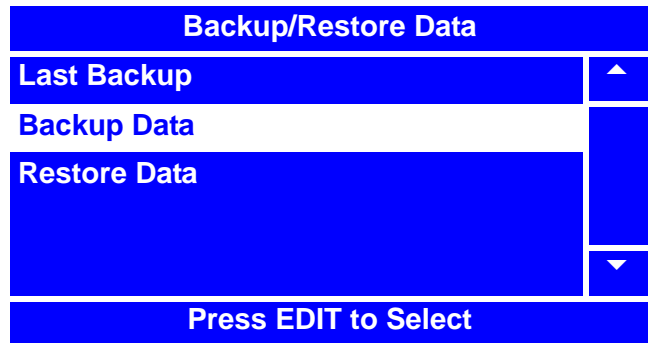

3. In the **Backup/Restore Data** menu, use  or  to select **Backup Data** and press .



NOTE

When  is pressed to save data, the system will reset.



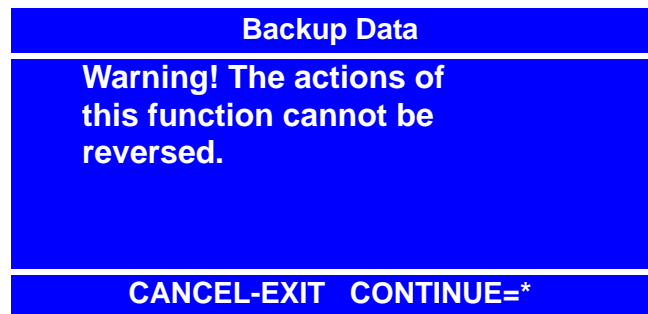

4. In the **Backup Data** menu, press  to save all data. Press  to cancel. You will be automatically returned to the **Backup/Restore Data** menu.







5. Press  once to return to the **System Settings** menu or twice to return to the **Main Menu**.

Restore Data

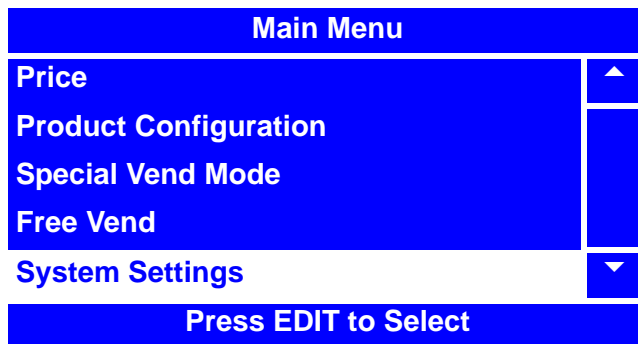
Restoring data will restore all saved data that was backed up in memory.

1. Press  until you reach the **Main Menu**, then use  or  to select **System Settings** and press .



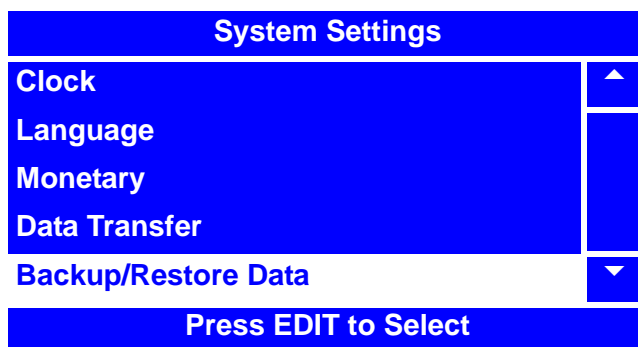

2. In the **System Settings** menu, use  or  to select **Backup/Restore Data** and press .



NOTE

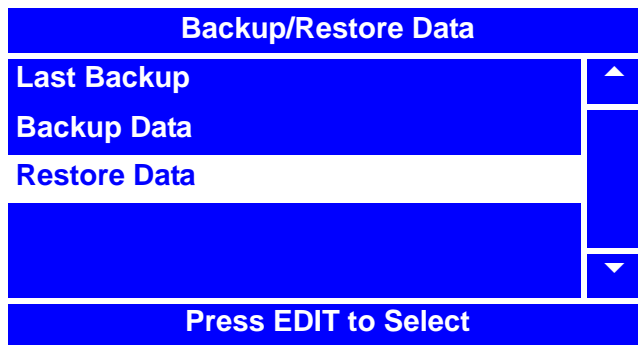

The **Last Backup** and **Restore Data** selections will not appear in the **Backup/Restore Data** menu unless data has previously been backed up.

3. In the **Backup/Restore Data** menu, use  or  to select **Restore Data** and press .



NOTE

When  is pressed to save data, the system will reset.



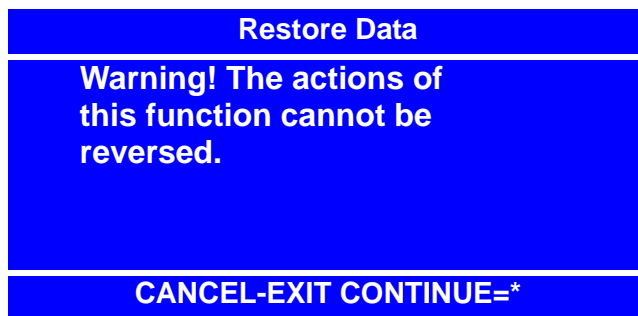





4. In the **Restore Data** menu, press  to save all data. Press  to cancel. You will be automatically returned to the **Backup/Restore Data** menu.



5. Press  once to return to the **System Settings** menu or twice to return to the **Main Menu**.



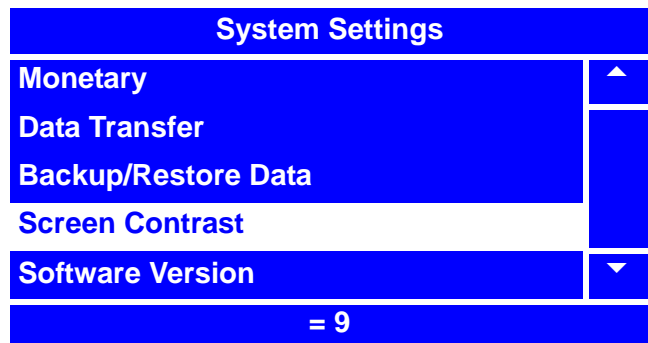
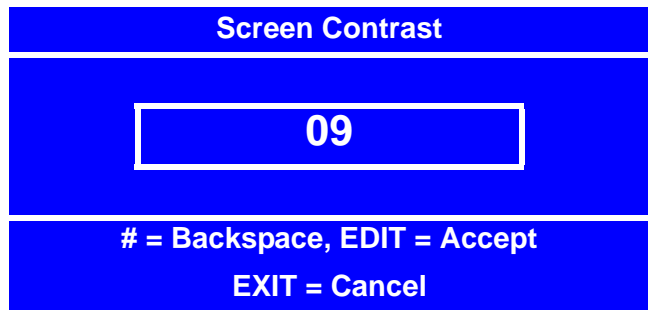
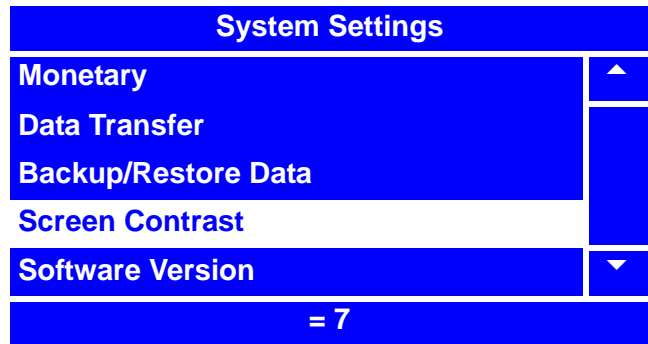
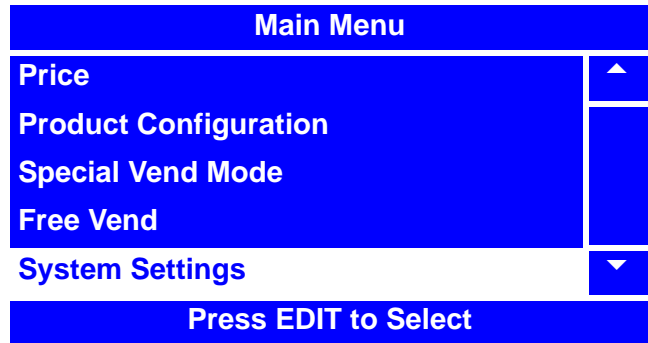

Set Screen Contrast

For most installations, the factory default screen contrast setting should be adequate. For installations with special considerations (very low or high ambient light), adjust the screen contrast to improve menu readability.



- Press  until you reach the **Main Menu**, then use  or  to select **System Settings** and press .
- In the **System Settings** menu, use  or  to select **Screen Contrast** and press .
- Using the number keys on either keypad, enter the setting for the screen contrast. If the setting is less than 10, use leading zeros:
 For example, if you wish to set the screen contrast at 9, press 0-9
 If you enter more than two numbers, the display will scroll back to the first digit.
- Press  to lock in the setting and return to the **System Settings** menu.
- In the **Systems Settings** menu, verify that the value you entered matches the status (bottom) line when **Screen Contrast** is selected.
- Press  once to return to the **Main Menu**.

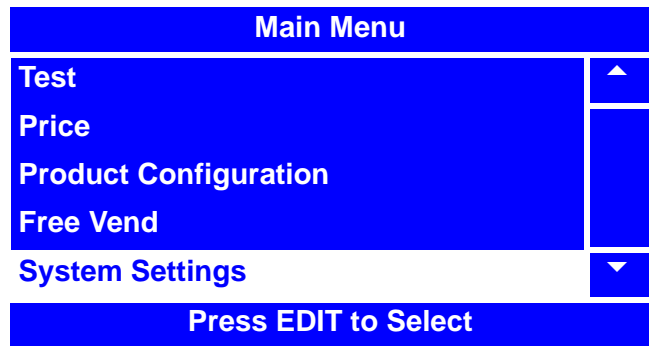

View Software Version

1. Press  until you reach the **Main Menu**, then use  or  to select **System Settings** and press .



2. In the **System Settings** menu, use  or  to select **Software Version** and press .

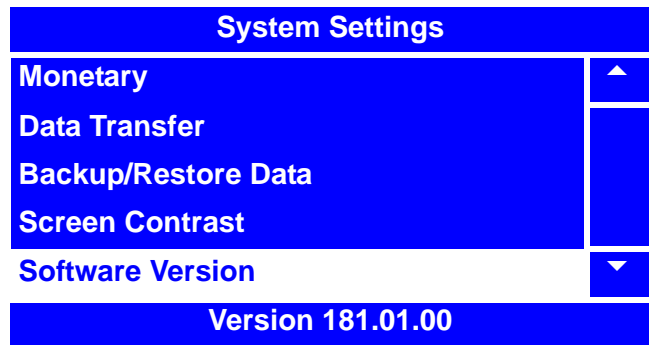





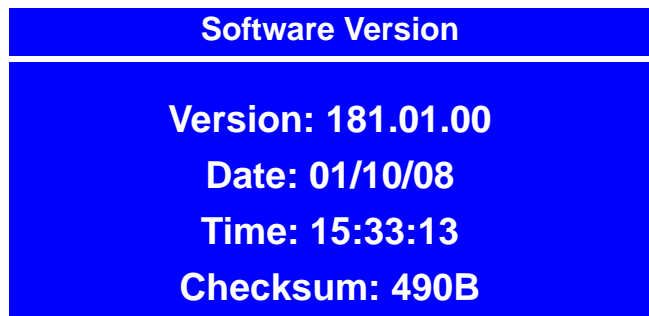



3. The **Software Version** screen displays the software version, date and time of software and checksum of software.

4. Press  once to return to the **System Settings** menu or twice to return to the **Main Menu**.







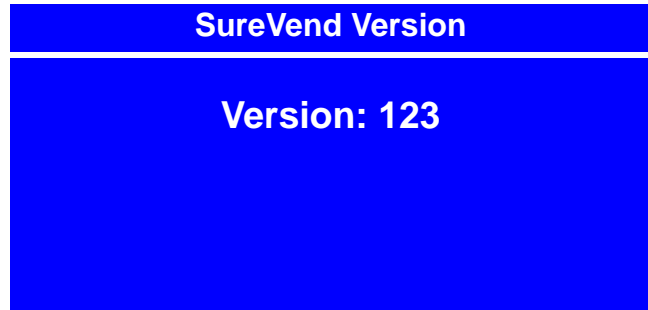
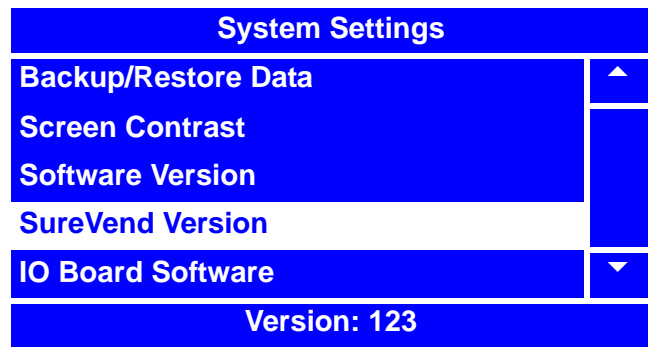
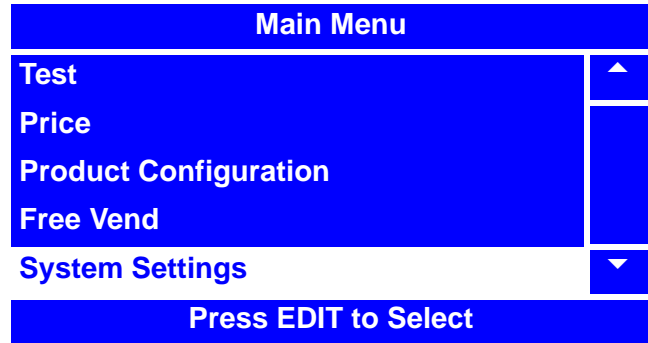



View SureVend™ Version

1. Press  until you reach the **Main Menu**
Menu, then use  or  to select **System Settings** and press .
2. In the **System Settings** menu, use  or  to select **SureVend Version** and press .
3. The **Software Version** screen displays the identifying number of the current SureVend™ software version.
4. Press  once to return to the **System Settings** menu or twice to return to the **Main Menu**.



View IO Board Software

1. Press  until you reach the **Main Menu**, then use  or  to select **System Settings** and press .
2. In the **System Settings** menu, use  or  to select **IO Board Software** and press .
3. The **IO Board Software** screen displays the software version of the IO Board Software.
4. Press  once to return to the **System Settings** menu or twice to return to the **Main Menu**.

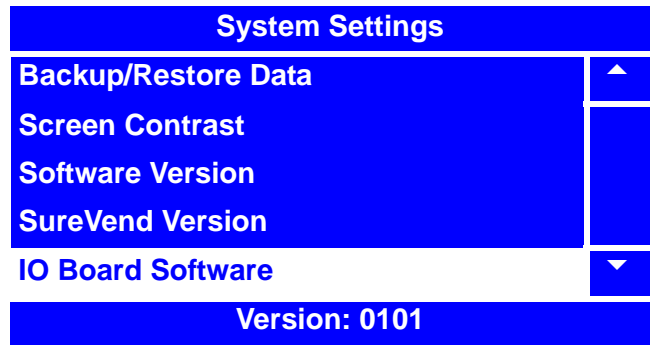
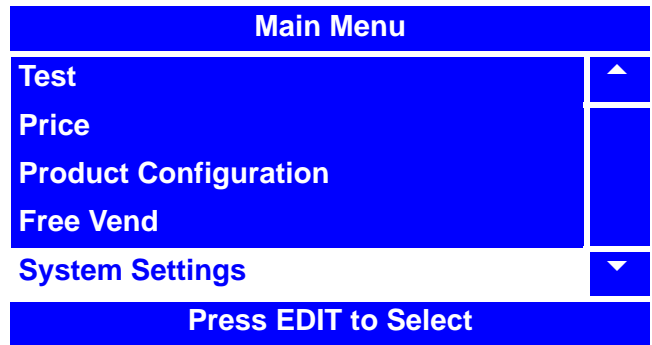













Set Temperature

A settable temperature is available only when the machine is configured to Merchant Chilled Snack



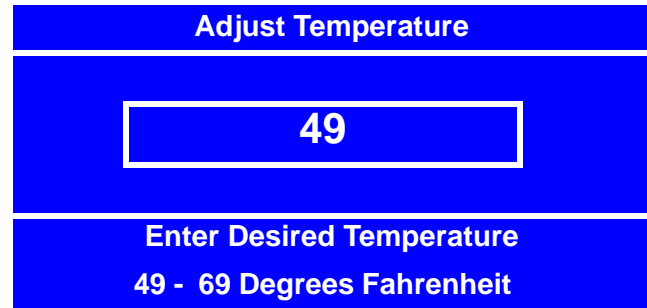
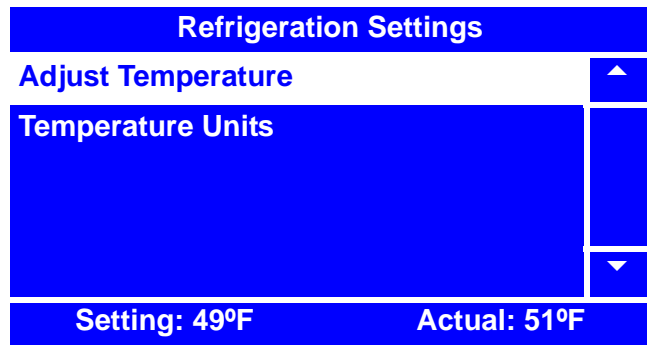
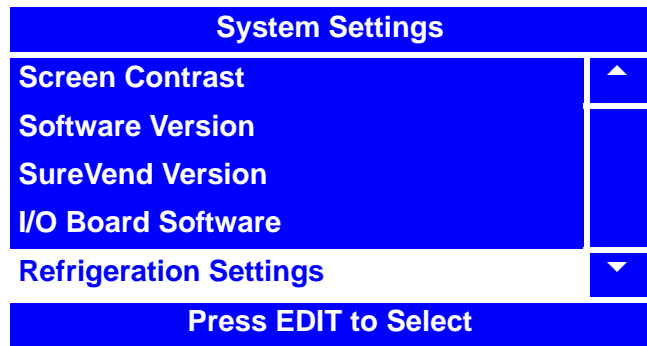
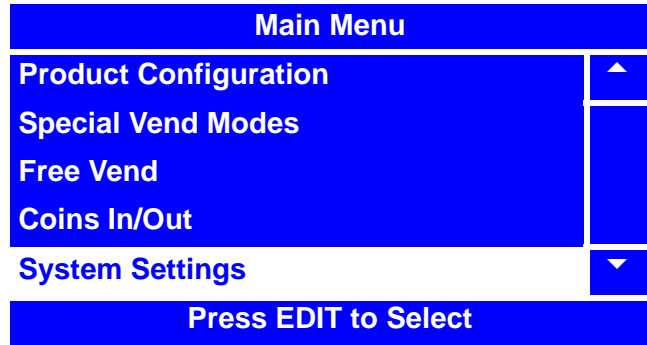

WARNING

The “Merchant Chilled Snack” setting does not have a health control circuit. It is not approved for the vending of perishable food items



- Press  until you reach the **Main Menu**, then use  or  to select **System Settings** and press .
- In the **System Settings** menu, use  or  to select **Refrigeration Settings** and press .
- In the **Refrigeration Settings** menu, use  or  to select **Adjust Temperatures** and press .
- In the **Adjust Temperature** screen, use the numeric keypad to enter the desired temperature between +49° and +69°F (9° to 20°C). Press  to lock in your selection and return to the **Refrigeration Settings** menu. Verify that the selected **Temperature** is displayed on the status (bottom) line.
- Press  once to return to the **System Settings** menu or twice to return to the **Main Menu**.





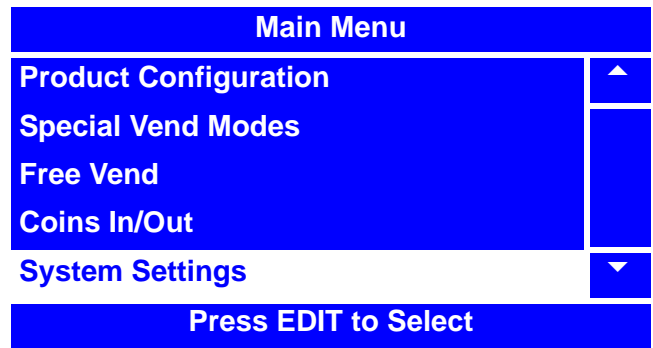

Select Tray and Selections to be Controlled by Health Control

1. Press  until you reach the **Main Menu**, then use  or  to select **System Settings** and press .

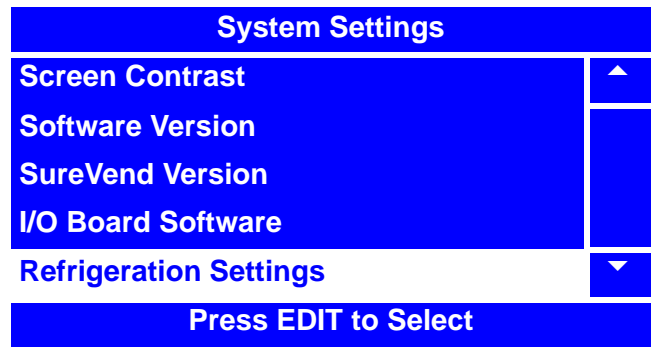



2. In the **System Settings** menu, use  or  to select **Refrigeration Settings** and press .

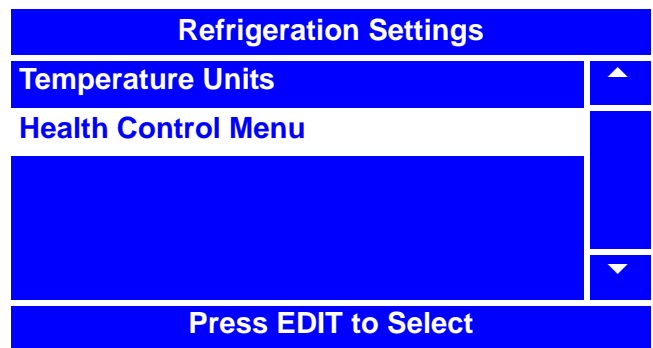

3. In the **Refrigeration Settings** menu, use  or  to select **Health Control** menu and press .



4. In the **Health Control** menu, use  or  to select the **Tray** you would like to view/modify for Health Control and press .



Health Control (continued)

5. In the **Tray** menu, use



to select the **Selection** you would like to modify for Health Control and

press  to turn on/off the Health Control for that selection.

Tray 1		
X	101	▲
X	102	
	103	
X	104	
	105	▼
* = Set or Clear All		

NOTE

An **X** to the left of the selection number means that the selection is currently being monitored by Health Control. In the example to the right selections 101, 102 and 104 are currently being monitored while selections 103 and 105 are not.

6. Press  once to return to the

Health Control menu or press  or con-

tinue pressing  until you reach the main menu.





NOTE

By pressing , you are able to quickly remove or add the “**X**”(s) from all selections on the selected tray.



Additional Information

- When the entire machine is set to “Health Control” and there is a “Health Control” error the display will read “Temporarily Out of Order” and no vending will be allowed.
- If only several selections or rows are set to “Health Control” and there is a Health Control error, no message is posted until a selection is made. Once the selection is made the display will say “Health Control Inhibited”.

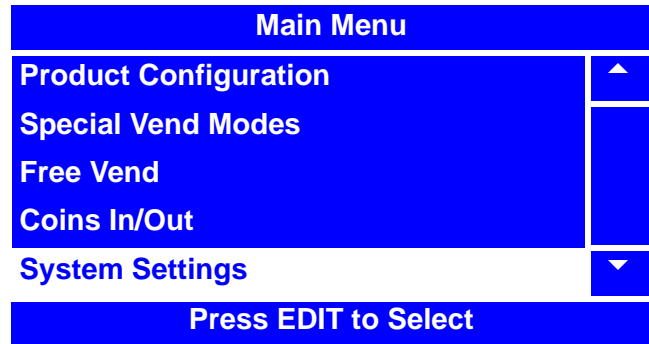

Set Temperature Units

1. Press  until you reach the **Main Menu**
Menu, then use  or  to select
System Settings and press .

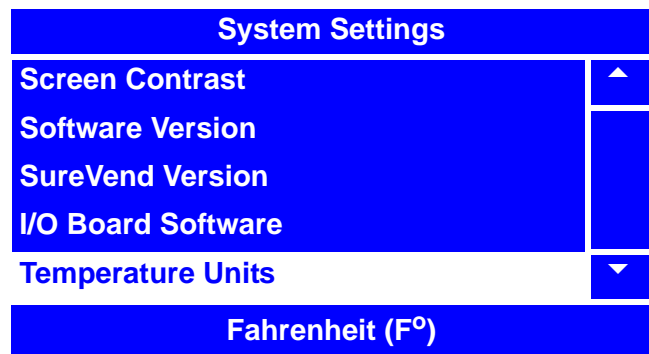

2. In the **System Settings** menu, use
 or  to select **Temperature Units** and press .



3. In the **Temperature Units** menu, use
 or  to select **Celsius** or **Fahrenheit**. The selected option is the one with the filled-in circle.

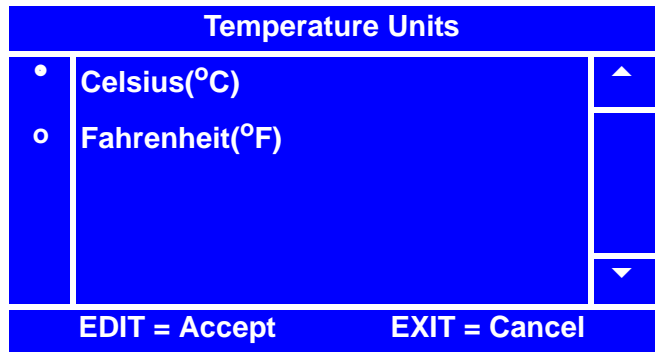

4. Press  to lock in your selection and return to the **System Settings** menu. Verify that the selected **Temperature Unit** is displayed on the status (bottom) line.

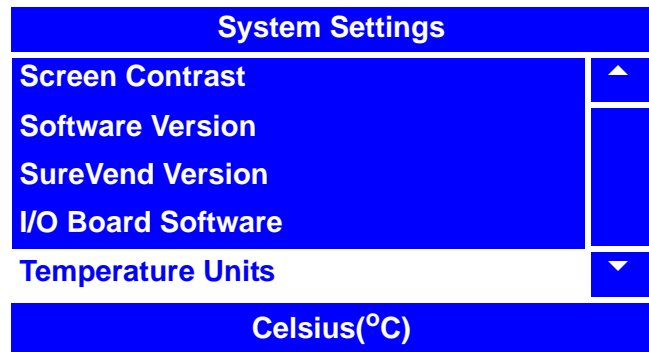

5. Press  once to return to the **System Settings** menu or twice to return to the **Main Menu**.





Set Idle Screen Time/Temp Options

One of these 3 options can be set to appear on the display:



None - “**Make a Selection**” appears with an alternating “**Ready**” message.

Time - The time will appear on the lower left hand corner of the display in addition to the alternating “**Make a Selection**” and “**Ready**” message.

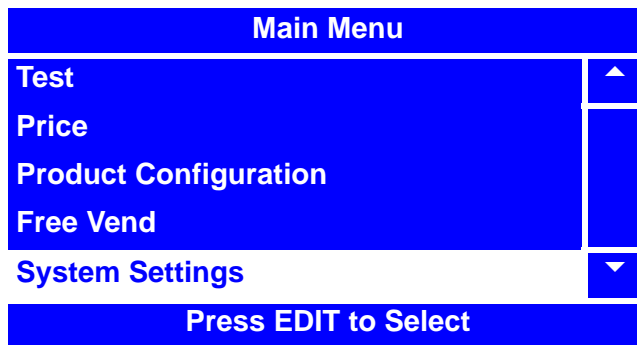

Time and Temp - The time will appear in the lower left hand corner and the water tank temperature will appear in the lower right hand corner of the display in addition to the alternating “**Make a Selection**” and “**Ready**” message.

1. Press  until you reach the **Main Menu**, then use  or  to select **System Settings** and press .



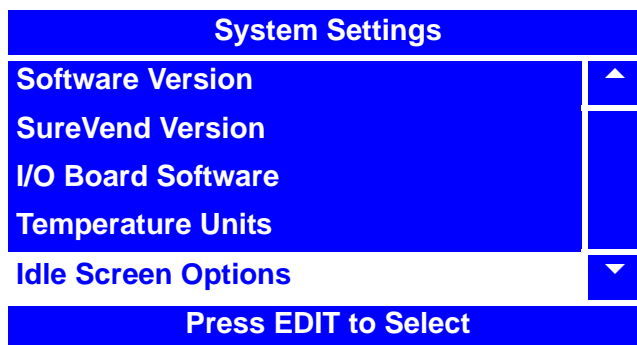

2. In the **System Settings** menu, use  or  to select **Idle Screen Options** and press .

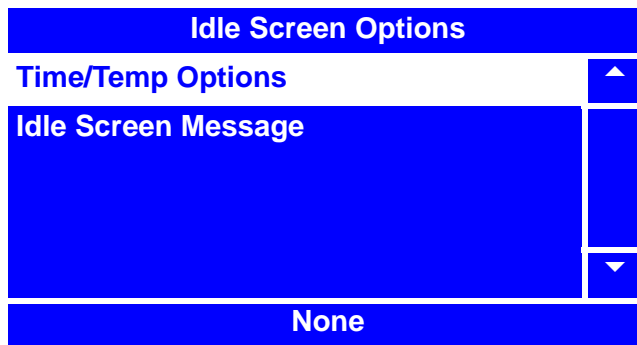

3. In the **Idle Screen Options** menu use  or  to select **Time/Temp Options** and press .



4. In the **Time and Temp Options** menu, use  or  to select **None**, **Time** or **Time and Temp**. The selected option is the one with the filled-in circle.

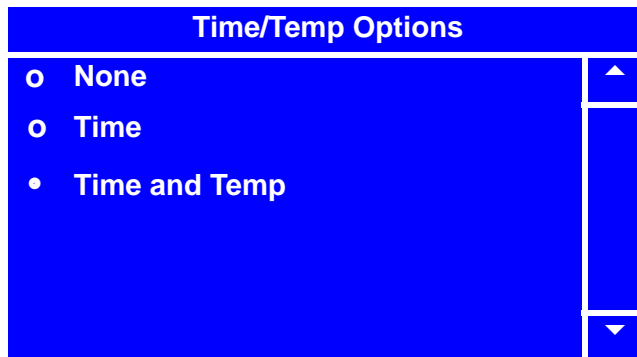



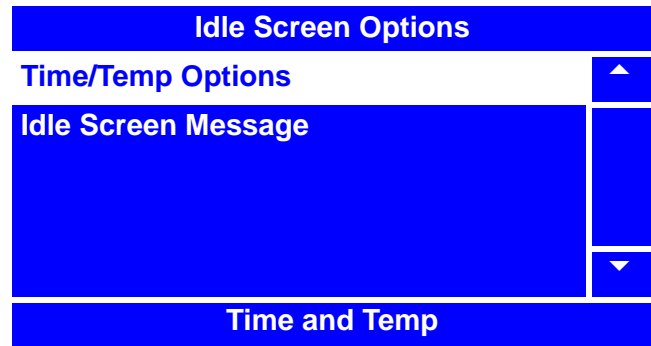

Set Idle Screen Time/Temp Options (continued)

5. Press  to lock in your selection and return to the **Idle Screen Options** menu. Verify that the selected **Time/Temp Option** is displayed on the status (bottom) line.



6. Press  once to return to the **Main Menu**.





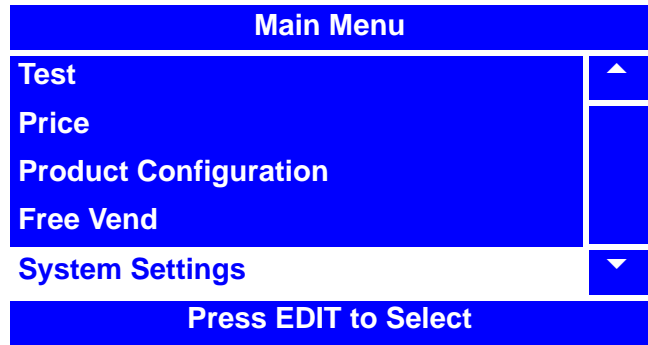

Set Idle Screen Message

1. Press  until you reach the **Main Menu**, then use  or  to select **System Settings** and press .

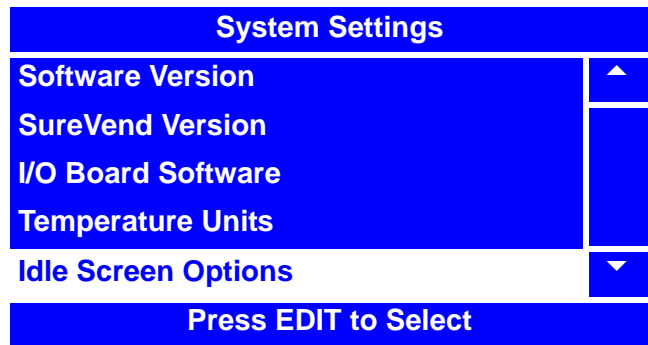



2. In the **System Settings** menu, use  or  to select **Idle Screen Options** and press .

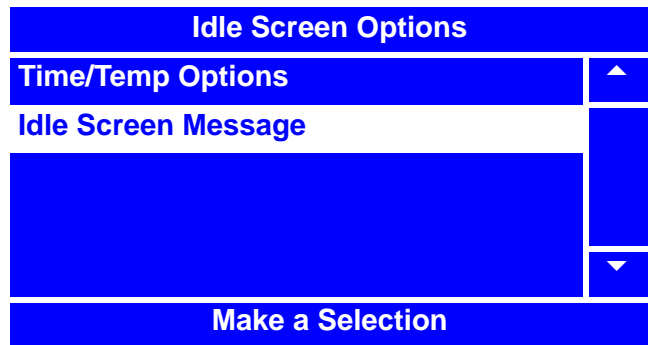

3. In the **Idle Screen Options** menu use  or  to select **Idle Screen Message** and press .



4. In the **Idle Screen Message** menu, use  or  to select **Make a Selection**, **Press Selection** or **Use Custom Message**. The selected option is the one with the filled-in circle.

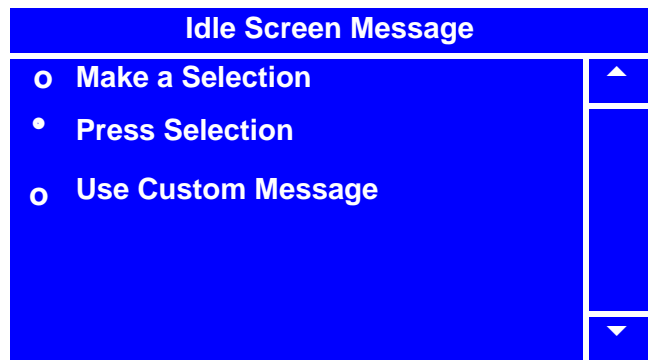

Set Idle Screen Message (continued)

5. If your selection was **Make a Selection** or **Press Selection**, press  to lock in your selection to return to the **Idle Screen Options** menu. Verify that the selected option is displayed on the status (bottom) line.

-OR-

If your selection was **Use Custom**

Message, press  to lock in your selection and the screen will cycle to the **Idle Screen Options** menu, with the only option being **Select Custom Message**.

NOTE

If your selection is **Use Custom Message**, follow steps 6-8. If not, skip to step 8.

6. Press  to access the **Select Custom Message** menu.

NOTE

To program custom messages, see "Set Custom Messages" on page 188

7. Use  or  to select the option



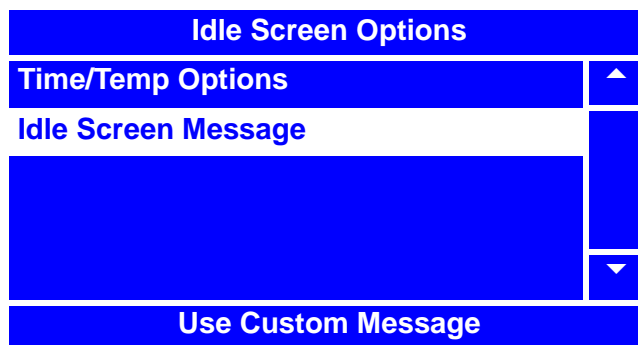
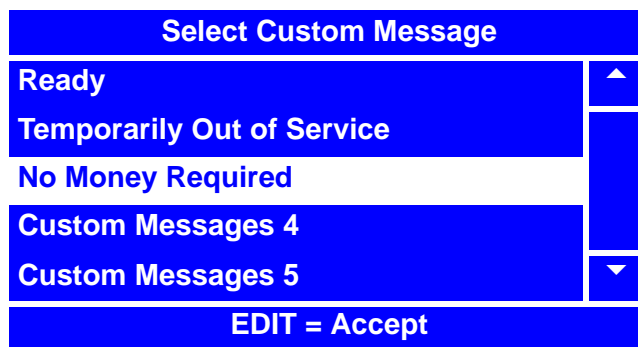
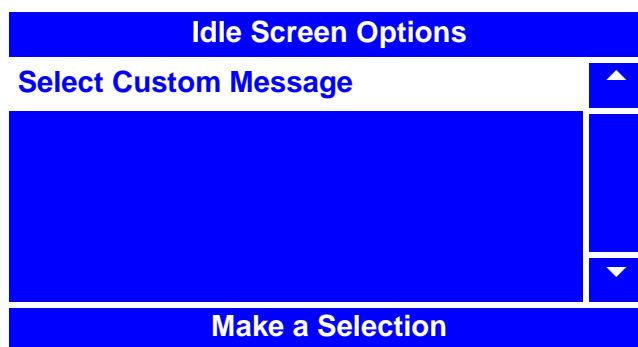
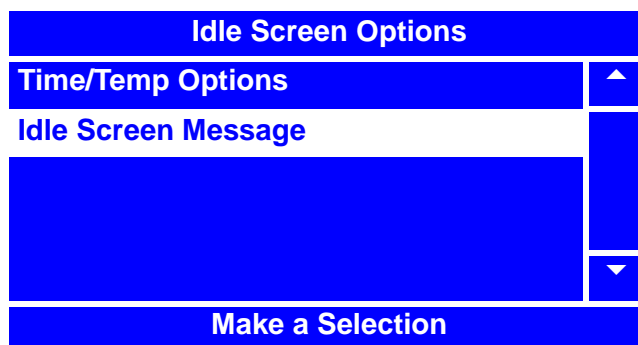

you desire and press . Verify that

Use Custom Message appears in the status (bottom) line of the **Idle Screen Options** menu.



8. Press  once to return to the **System Settings** menu, or twice to return to the **Main Menu**.





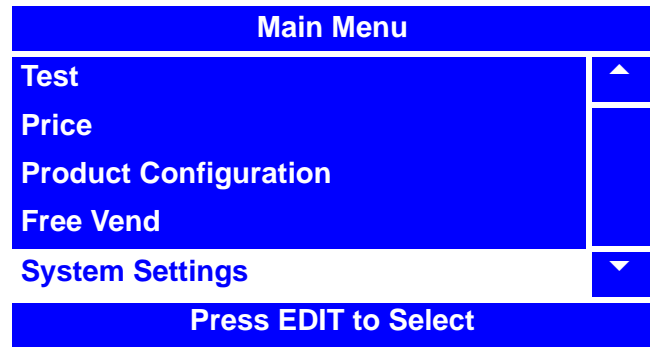

Set Custom Messages

1. Press  until you reach the **Main Menu**, then use  or  to select **System Settings** and press .

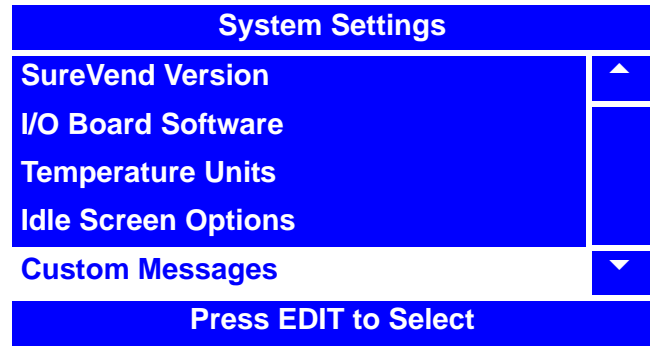



2. In the **System Settings** menu, use  or  to select **Custom Messages** and press .

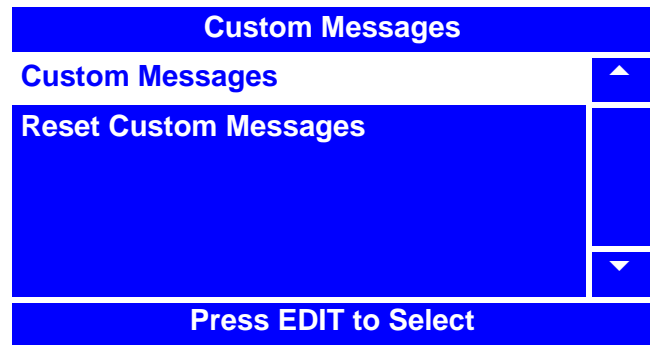

3. In the **Custom Messages** menu, use  or  to select **Custom Messages** and press .



4. In the second **Custom Messages** menu, use  or  to select the custom message you wish to edit and press .

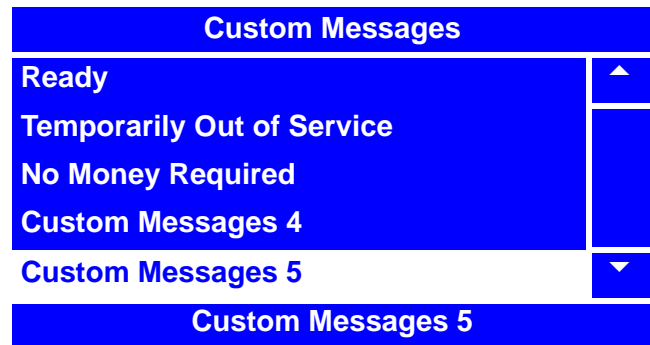

Set Custom Messages (continued)

5. In the **Custom Messages X** screen, use the



and



to move the cursor to the

left and right. Press



to remove the

letters and numbers. Press



to move

to uppercase and lowercase letters.

Press 0-9 to add a letter or number. Press the number once to bring up the character screen (lower bottom). Press the number again to scroll to the character. Refer to the "NUMERIC/CHARACTER TABLE" on page 191.

6. Press



to lock in your new custom

message and return to the previous **Custom Messages** menu. Verify that the new custom message that you just entered appears in the status (bottom) line when the corresponding **Custom Messages X** is selected.

7. Press







once to return to the first

Custom Messages menu, twice to return to the **System Settings** menu, or three times to return to the **Main Menu**.





Reset Custom Messages

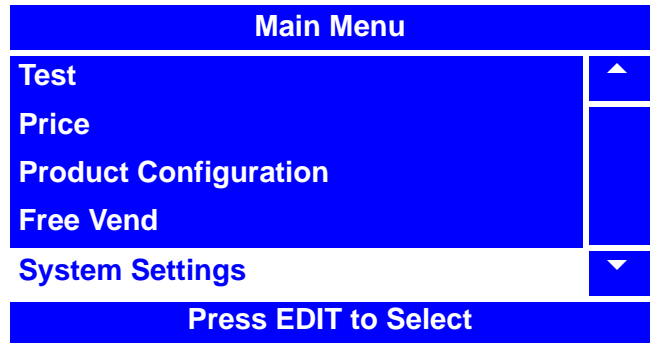

This procedure allow you to erase all custom set messages and restore the merchandiser's message data to factory default.

1. Press  until you reach the **Main Menu**, then use  or  to select **System Settings** and press .



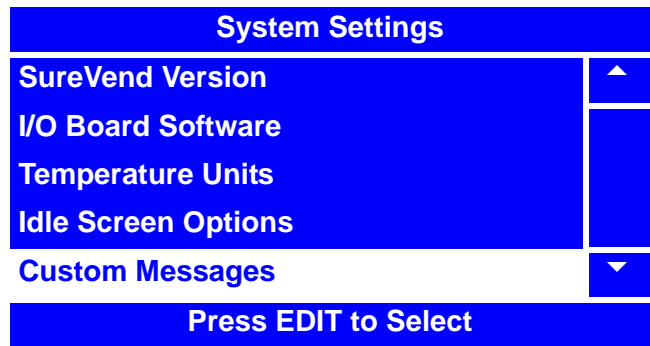

2. In the **System Settings** menu, use  or  to select **Custom Messages** and press .



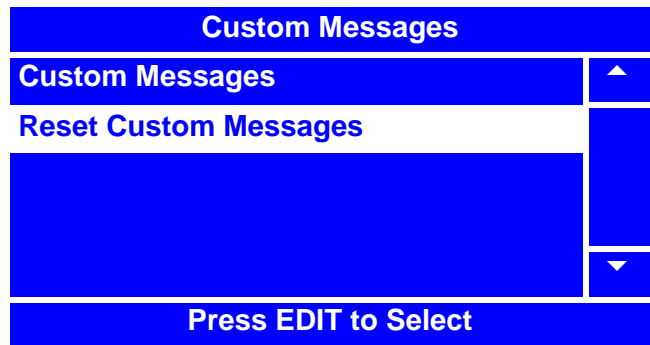















3. In the **Custom Messages** menu, use  or  to select **Reset Custom Messages** and press .







4. In the **Reset Custom Messages** menu, press  to restore Custom Messages to factory default. Press  to cancel. You will be automatically returned to the **Custom Messages** menu.



5. Press  once to return to the **System Settings** menu, or twice to return to the **Main Menu**.



NUMERIC/CHARACTER TABLE	
	« (backspace) », » (space), (paragraph) (new line), - / \$ @ % # & 0
	, . ? ! ' ; : " * 1
	a b c 2
	d e f 3
	g h i 4
	j k l 5
	m n o 6
	p q r s 7
	t u v 8
	w x y z 9
	Moves the cursor backwards.
	Moves the cursor forward.
	Saves the message.
	Backs out of the menu, does not save message.
	Removes characters and numbers.
	Switches the lower case letters to uppercase letters.



Talker Setup

- Press  until you reach the **Main Menu**, then use  or  to select **System Settings** and press .

NOTE

The **Talker Setup** selection enables you to turn on or off your merchandiser's speaker. If your merchandiser does not have a speaker installed, leave the **Talker Setup** selection set to **Off**.

- In the **System Settings** menu, use  or  to select **Talker Setup** and press .

- In the **Talker Setup** menu, press  or  to select **On** or **Off**.
The selected option is the one with the filled-in circle.

- Press  to lock in the selection and return to the **System Settings** menu.



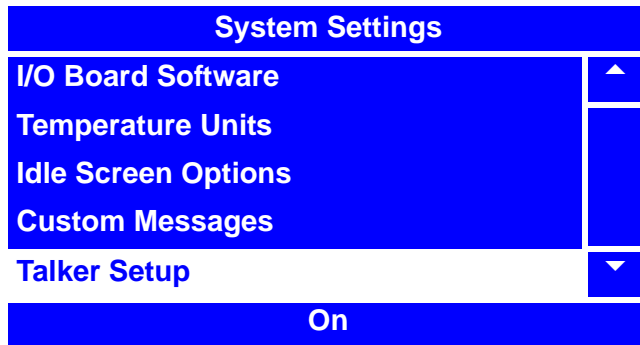
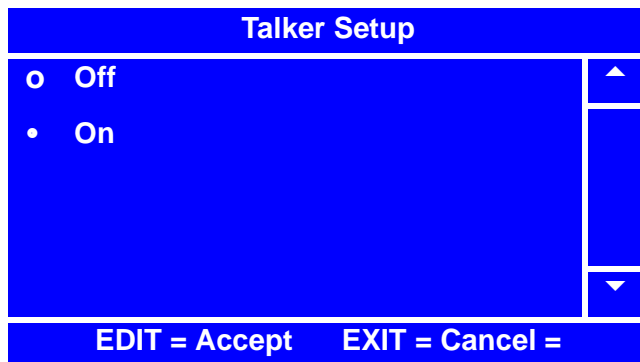
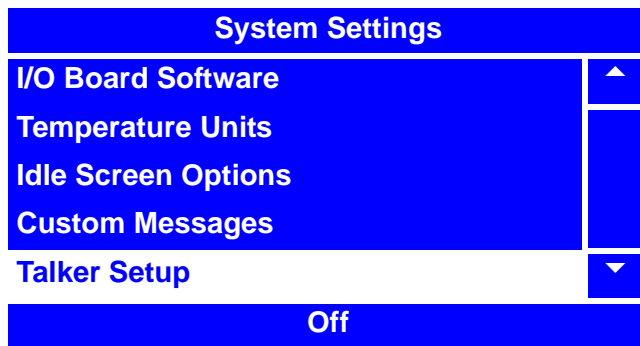
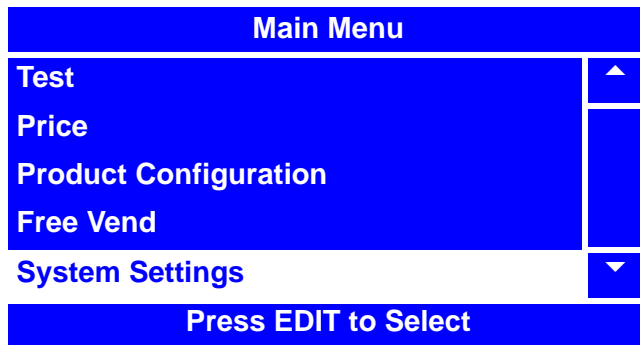

- Verify that the status (bottom) line of the **System Settings** menu displays the selected option (**On** or **Off**) when **Talker Setup** is highlighted.



- Press  once to return to the **System Settings** menu or twice to return to the **Main Menu**.



Programming: Security Codes

Enter Security Code

1. Press  until you reach the **Main Menu**, then use  or  to select **Security Codes** and press .

2. In the **Security Codes** menu, use  or  to select **Enter PIN** and press .

NOTE

The factory default setting for the **Supervisor PIN** code is **0000**. The Supervisor Mode grants access to **Main Menu** selections that can be programmed to not appear in the **Main Menu** unless the Supervisor Mode is activated. To change the Supervisor PIN code, see “Edit the Supervisor PIN” on page 194.

3. Enter the **Supervisor PIN** code. The code should be four digits. Be careful when entering the PIN code – if you enter more than four numbers, the display will scroll back to the first digit.

4. Press  to lock in the setting.

5. When a correct PIN code is entered, the screen will display **Supervisor Approved** then cycle back to the **Security Codes** menu. The respective menu(s) will be accessible from the **Main Menu**. Proceed to:
 - a. The **Main Menu** by pressing .

-or-

- b. “Edit the Supervisor PIN” on page 194.

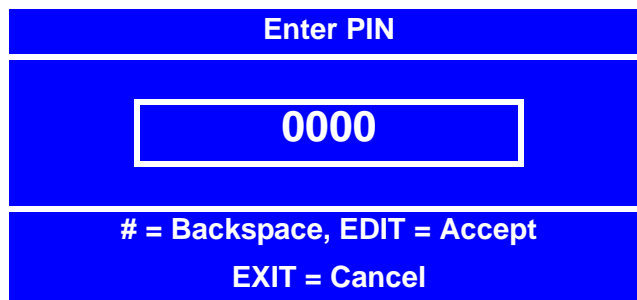
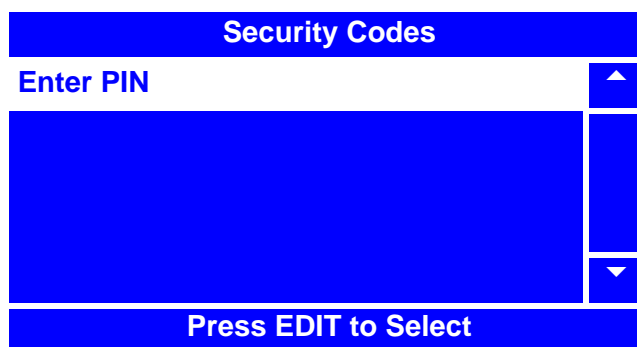
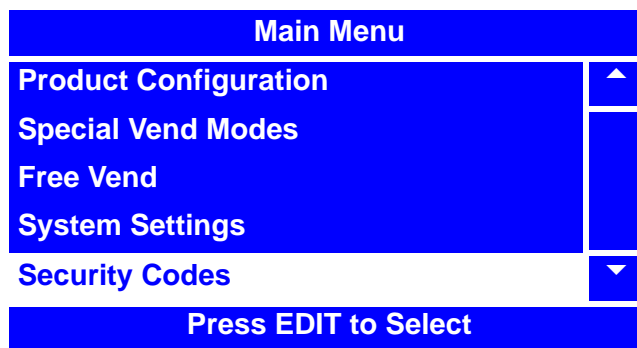

Edit the Supervisor PIN

The **Supervisor PIN** code on the Merchant™ can be changed.

First, follow the procedure in “Enter Security Code” on page 193 to unlock the **Edit Supervisor PIN** menu.

1. Once the current **Supervisor PIN** is entered, access the **Security Codes** menu by

pressing  until you reach the **Main Menu**,

then use  or  to select

Security Codes and press .

2. In the **Security Codes** menu, use

 or  to select **Edit**

Supervisor PIN and press .

NOTE

If **Edit Supervisor PIN** does not display in the **Security Codes** menu, follow the procedure in “Enter Security Code” on page 193 to unlock the **Edit Supervisor PIN** menu.

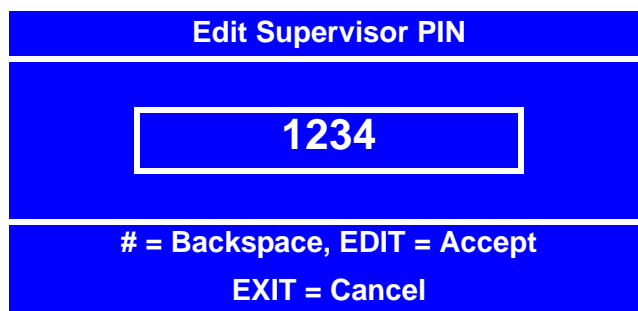
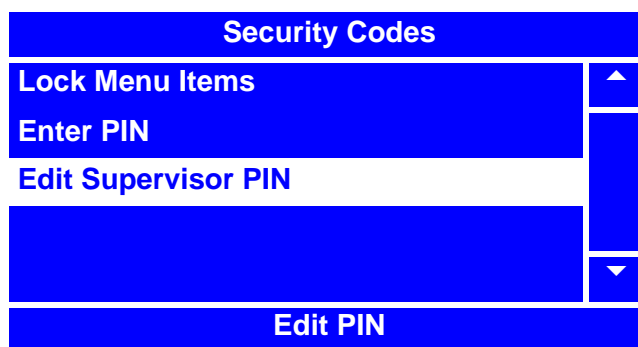
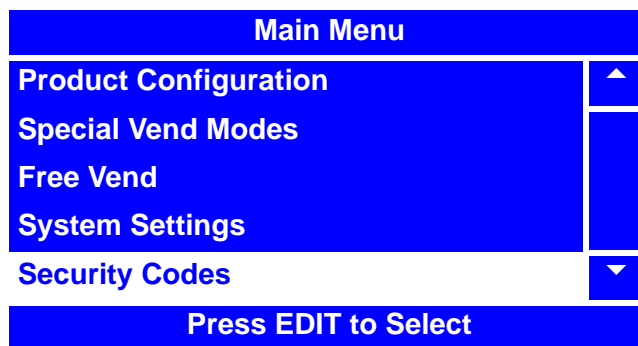

3. In the **Edit Pin** screen, enter a new PIN number and press . The code should be four digits. Be careful when entering the PIN code – if you enter more than four numbers, the display will scroll back to the first digit.

4. Write the new **Supervisor PIN** code number down and keep it in a secure place.

5. Press  to lock in the setting and return to the **Security Codes** menu.





6. Press  once to return to the **Main Menu**.



Lock/Unlock Menu Items

The following menu selections can be locked or unlocked in this **Lock/Unlock Menu Items** procedure:

- Clear Data
- Data Recall
- Test
- Price
- Product Configuration
- Free Vend
- Special Vend Modes
- System Settings

First, follow the procedure in “Enter Security Code” on page 193 to unlock the **Lock Menu Items** menu.

1. Once the **Supervisor PIN** is entered, access the **Security Codes** menu by pressing  until you reach the **Main Menu**, then use  or  to select **Security Codes** and press .

2. In the **Security Codes** menu, use  or  to select **Lock Menu Items** and press .

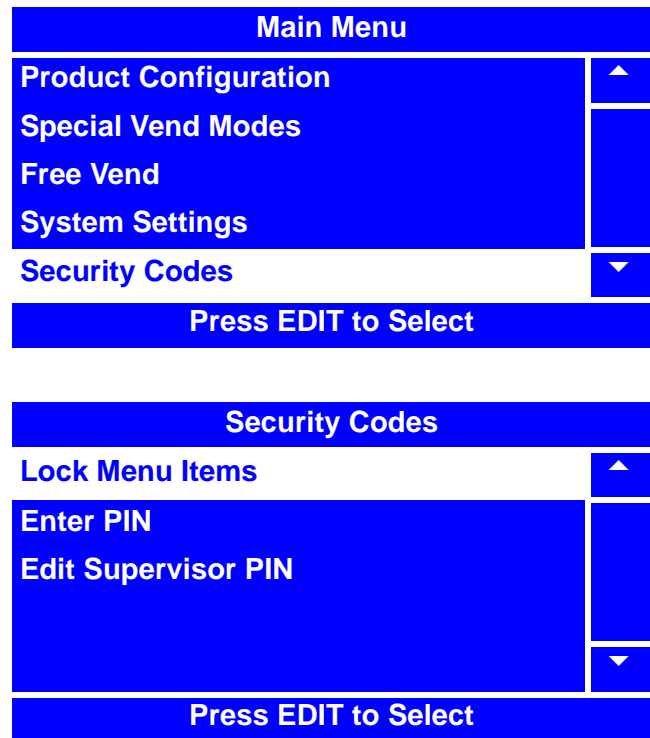

NOTE

If **Lock Menu Items** does not display in the **Security Codes** menu, follow the procedure in “Enter Security Code” on page 193 to unlock the **Lock Menu Items** menu.

Lock/Unlock Menu Items (continued)

3. Select the Menu Item(s) you wish to make available/unavailable by using the



or





to select a Menu Item and

then pressing  to remove or add the "X"(s) next to the Menu Item(s).

Lock Menu Items		
	Clear Data	▲
	Data Recall	
X	Test	
	Price	
X	Product Configuration	▼
* = Set or Clear All		

NOTE

By pressing , you are able to quickly remove or add the "X"(s) from all listed Menu Items.

4. Press  to lock in your selection(s) and return to the **Security Codes** menu.

5. Press  to return to the **Main Menu**.

448/449 Merchant Refrigeration Removal

1. Open the door and turn the power off.
2. Lower the delivery bin and remove the stop rod.
3. Unplug the harness to the Surevend boards and remove it from where it runs along the front of the machine floor. Set the harness to the right out of the way.
4. Remove the delivery bin. (**taking care not to damage the insulation**).
5. Remove the bottom tray from the machine to gain access to the horizontal barrier.
6. Unplug the harnesses to the refrigeration unit and temperature sensors on the left side of the refrigeration unit. Take the harnesses off where they run along the top of the horizontal barrier.
7. Remove the screws along the back of the horizontal barrier and the screws holding the front left and right side angle brackets.
8. To remove the horizontal barrier you **must lift the barrier up before** pulling it forward and out of the machine.
9. Remove the condenser inlet screen on the floor of the machine.
10. Remove the bolt holding the refrigeration lock plate on the left side. The plate can be removed by using a large screwdriver as a lever to pry it up and out.
11. Slide the refrigeration unit forward and to the left and out of the front of the machine.

448/449 Merchant Refrigeration Installation

1. Reverse procedures above to install the refrigeration unit.
2. Be sure to push the unit to the back and to the right. The bolt hole in the refrigeration lock plate will line up with the bolt hole in the floor of the machine when the unit is position correctly.
3. Tap the lock plate down and into position.
4. After completing the installation, test the machine for proper operation.

Alphabetical Index

A

Accept on low change, set	144
Acceptor, bill (optional)	6
Anti-Jackpot timer, SureVend, set	101

B

Backup, last timed, timed events, view	72
Backup, last, view	173
Base plate, installing	37
Bill acceptor (optional)	6
Bill validator, identification numbers, view	75
Bill validator, select	143
Bill validator, testing	41
Bin, delivery, removing	9
Button, OK, enable	129

C

CA304 data type, set	157
Calibration, SureVend, test	84
Cancel key	6
Card reader, identification numbers, view	76
Card reader, select	148
Card revalue, set	149
Change, low, accept on, set	144
Change, without purchase, set	141
Character/Numeric table	191
Check, operational readiness	39
Clock set, last, timed events, view	71
Code, security, enter	193
Codes, security, programming	193
Coin mechanism, identification numbers	74
Coin mechanism, loading	38
Coin mechanism, select	139
Coin mechanism, setting up	38
Coin return key	6
Coins, in/out, view	140
Combo vends	125
Communication mode, set	155
Configuration and sales data, save to key .	165
Configuration data and Config & sales data, delete from Data Key	171

Configuration data, load from data key to machine	169
Configuration data, save to data key	163
Configuration version, view	97
Configuration, product, programming	97
Configuration, selection	103
Contrast, screen, set	176
Controller, main, PCB display	7
Controls and indicators	6
Couple motors	108
Coupler, spiral, installing	22
Coupler, spiral, installing when used with coupler bearing	23
Coupler, spiral, installing when used with motor	22
Coupler, spiral, orientation	22
Coupler, spiral, removing	20
Credit for failed vend, set	153
Custom dividers, installing	16
Custom dividers, removing	16
Custom messages, reset	190
Custom messages, set	188
Customer keypad	42

D

Data clear, timed events, view last	68
Data key, connect and disconnect	161
Data Key, delete configuration data and config & sales data from	171
Data key, load configuration data	169
Data key, save configuration and sales data	165
Data key, save configuration data to	163
Data key, view image info (data description)	167
Data list, set	156
Data reset mode, set	158
Data transfer, set	155
Data type, CA304, set	157
Data, backup	174
Data, configuration and sales, save to key	165
Data, configuration, load	169
Data, configuration, save to data key	163
Data, non resettable, view	45
Data, print	77

Data, restore 175
 Data, vend, clear 65
 Data, vend, non resettable, cash 49
 Data, vend, non resettable, cashless 51
 Data, vend, non resettable, token 53
 Data, vend, non resettable, view by product 47
 Data, vend, resettable, cash 59
 Data, vend, resettable, cashless 61
 Data, vend, resettable, token 63
 Data, vend, resettable, view 55
 Data, vend, view by product 57
 Date, set 135
 Daylight saving time, set 137
 Delivery bin, removing 9
 Diagnostic error messages, table 79
 Display 42
 Display, keypad 6
 Display, test 92
 Door, main, openings, timed events, view ... 66

E

error messages, diagnostic, table 79
 Errors, check for 78
 Event reset mode, set 159
 Events, timed - time of day events 109, 114

F

Failed vend, credit for, set 153
 FIFO 104
 FIFO setup, adding groups 104
 FIFO setup, groups, deleting 105
 FIFO setup, groups, editing 106
 FIFO, adding groups, setup, 104
 Final installation 36
 Firmware selection, serial flash menu 162
 First In, First Out (FIFO) 104
 Free vend, programming 130
 Free vend, turn on/off 130

G

Gear, installing 21
 Gear, orientation of 21
 Gear, placement of 21
 Gear, use of 21

Groups, FIFO setup, deleting 105
 Groups, FIFO setup, editing 106

H

Harness, motor, connecting 17
 Harness, motor, disconnecting 17

I

ID number, machine 131
 Idle screen message, set 186
 Idle screen, set time/temp options 184
 Image info (data description), view on data key 167
 Indexing procedure, spiral (one spiral, one motor) 40
 Indexing procedure, spiral (two spirals, one or two motors) 40
 Indicators, controls and 6
 Individual selections, set prices for 94
 Initial set-up 9
 Installation, final 36
 Interlock switch 6
 IO board software, view 179

K

Key, cancel 6
 Key, coin return 6
 Key, data, connect and disconnect 161
 Key, Data, delete configuration data and config & sales data from 171
 Key, data, load configuration data from to machine 169
 Key, data, save configuration 165
 Key, data, save configuration data to 163
 Key, data, view image info..... 167
 Key, selection 6
 Keypad display 6
 Keypad, customer 42
 Keypad, service 6, 42
 Keypad, service, shortcut keys 43
 Keypads, test 93
 Keys, other 44
 Keys, shortcut, service keypad 43

L

Labels, selection ID, installing 34
 Language, select 138
 Last backup, view 173
 Last clock set, timed events, view 71
 Last data clear, timed events, view 68
 Last price setting, timed events, view 69
 Last vend, timed events, view 70
 List, data, set 156
 Location, machine information 133
 Low change message, set 142
 Low change, accept on, set 144
 Low voltage switch 6
 Lower panel, removing 9

M

Machine ID number 131
 Machine information, location 133
 Main controller PCB display 7
 Main door openings, timed events, view 66
 Main keypad, test 93
 Main PCB identification numbers, view 73
 Mechanism, coin, select 139
 Menu items, lock/unlock 195
 Merchandiser, leveling 36
 Merchandiser, positioning 11
 Merchandiser, reassembling 10
 Merchandiser, turning On/Off 8
 Merchandiser, unpacking 5
 Message, idle screen, set 186
 Message, low change, set 142
 Messages, custom, reset 190
 Messages, custom, set 188
 messages, error, diagnostic, table 79
 Mode, winner 122
 Motor harness, connecting 17
 Motor harness, disconnecting 17
 Motor status detail menu screen, figure 88
 Motor test, return coin 89, 90, 91
 Motor with a spiral bearing, replacing 16
 Motor, removing 16
 Motor, spiral, installing 20
 Motor, spiral, removing 20
 Motor, status detail 86

Motor, test summary 85
 Motors, couple 108
 Moving, merchandiser through doorway 9
 Multiple vend mode, set 151

N

Non resettable data, view 45
 Non resettable sales, cash 49
 Non resettable sales, cashless 51
 Non resettable sales, token 53
 Non resettable sales, view by product 47
 Numeric/Character table 191

O

OK button, enable 129
 One price, set for entire machine 95
 Options, SureVend, set 99

P

Panel, lower, removing 9
 Panel, top, removing 9
 PCB display, main controller 7
 PCB, main, identification numbers, view 73
 PIN code, supervisor, factory default 193
 PIN, supervisor, edit 194
 Power losses, timed events, view 67
 Power, requirements 5
 Powersave 114
 Price labels, installing and setting 32
 Price roll, adjusting 33
 Price setting, timed events, view last 69
 Price, set one for the entire machine 95
 Prices, for individual selections, set 94
 Prices, set by trays 96
 Print data 77
 Product configuration, programming 97
 Product pusher, usage 28
 Product spacers, installing 25
 Product spacers, removing 25
 Product, loading trays with 26
 Products, loading trays 26
 Programming, introduction 42
 Pusher, product, usage 28

R

Reader, card, identification numbers, view .. 76
 Reader, card, select 148
 Reset mode, data, set 158
 Reset mode, event, set 159
 Resettable sales data, view 55
 Resettable sales, cash 59
 Resettable sales, cashless 61
 Resettable sales, clear 65
 Resettable sales, token 63
 Resettable sales, view by product 57
 Retainer, spiral wall, usage 27
 Return coin motor, test 89, 90, 91
 Revalue, card, set 149

S

Sales and configuration data, save key 165
 Sales data, resettable, view 55
 Sales, non resettable, cash 49
 Sales, non resettable, cashless 51
 Sales, non resettable, token 53
 Sales, non resettable, view by product 47
 Sales, resettable, cash 59
 Sales, resettable, cashless 61
 Sales, resettable, clear 65
 Sales, resettable, token 63
 Sales, resettable, view by product 57
 Screen contrast, set 176
 Screen, idle, set time/temp options 184
 Security code, enter 193
 Security codes, programming 193
 Selection configuration 103
 Selection ID labels, installing 34
 Selection key 6
 Selection, test vend 82
 Selections, individual, set prices for 94
 Service keypad 6, 42
 Service keypad, shortcut keys 43
 Service keypad, test 93
 Settings, system, programming 131
 Set-up, initial 9
 Set-up, snack section 11
 Shortcut keys, service keypad 43
 Snack section set-up 11

Software version, view 177
 software, IO board, view 179
 Spacers, product, installing 25
 Spacers, product, removing 25
 Spiral bearing, installing 16
 Spiral bearing, motor with, replacing 16
 Spiral coupler, installing 22
 Spiral coupler, installing when used with
 coupler bearing 23
 Spiral coupler, installing when used with
 motor 22
 Spiral coupler, orientation 22
 Spiral coupler, removing 20
 Spiral motor, installing 20
 Spiral motor, removing 20
 Spiral wall retainer, usage 27
 Spiral, clockwise or counterclockwise, use of 19
 Spiral, installing 19
 Spiral, removing 19
 Status, detail, motor 86
 Supervisor PIN code, factory default 193
 Supervisor PIN, edit 194
 SureVend Anti-Jackpot timer, set 101
 SureVend calibration, test 84
 SureVend options, set 99
 SureVend version, view 178
 SureVend, test vend without 83
 SureVend, turn off 98
 SureVend, turn on 98
 Switch, interlock 6
 Switch, low voltage 6
 System settings, programming 131

T

Talker, setup 192
 Temperature units, set 180, 181, 182, 183
 Test, summary, motor 85
 Testing, return coin motor 89, 90, 91
 Time, daylight saving, set 137
 Time, set 136
 Time/Temp options, idle screen, set 184
 Timed backup, last, timed events, view 72
 Timed events - time of day events 109, 114
 Token enable 128
 Top panel, removing 9

Trays, installing in merchandiser	14	Vend data, non resettable, token	53
Trays, loading with product	26	Vend data, non resettable, view by product .	47
Trays, moving up or down	23	Vend data, resettable, cash	59
Trays, operating outside merchandiser	16	Vend data, resettable, cashless	61
Trays, placing in loaded position	11	Vend data, resettable, token	63
Trays, product loading	26	Vend data, resettable, view	55
Trays, removing	10, 13, 15	Vend data, view by product	57
Trays, returning to vending position	31	Vend mode, multiple, set	151
Trays, set prices by	96	Vend, failed, credit for, set	153
Trays, setting up to vend products	12	Vend, free, turn on/off	130
Trays, setting up to vend wide products	12	Vend, last, timed events, view	70
TriTeq Lock	38	Vend, selection, test	82
V			
Validator, bill, identification numbers, view ..	75	Vend, test without SureVend	83
Validator, bill, select	143	Vending products, tray set-up	12
Validator, bill, testing	41	Vending wide products, tray set-up	12
Vend data, clear	65	Vending, "lunchbucket"	28
Vend data, non resettable, cash	49	Vends, combo	125
Vend data, non resettable, cashless	51	W	
		Winner mode	122